

H.264 • SD/SDHC Card Slot • Rack Mount Design

VIDEO SERVER

Quick Installation Guide

English | 繁體中文 | 簡體中文 | 日本語 | Français | Español | Deutsch | Português | Italiano | Türkçe | Polski | Русский | Česky | Svenska | العربية



VS8801

*8-CH Audio and Video
Single Stream*



VS8401

*4-CH Audio and Video
Simultaneous Dual Streams*

This guide describes the basic functions of VS8801/8401.
All detailed information is described in the user's manual.



安装警告

- 如果视频服务器冒烟或有异常气味，请立即关闭。
- 请将视频服务器远离水源。如果弄湿网络摄像头，请立即关闭。



如果发生上述情况请联系您的经销商。



如果发生上述情况请联系您的经销商。

- 不要将视频服务器放置在电视或烤箱等热源附近。
- 工作温度请参考用户手册。

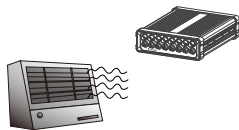

- 不要将视频服务器暴露于阳光直射的地方。
- 切勿将视频服务器放在高温环境中。

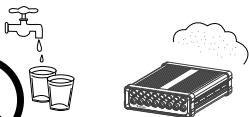
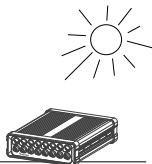

- 切勿将视频服务器放置在不稳定的表面上。
- 闪电时不要接触视频服务器。

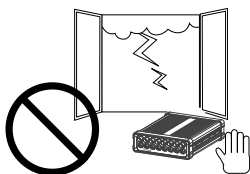
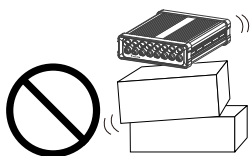

- 切勿自行拆解视频服务器。

- 切勿使视频服务器坠落。

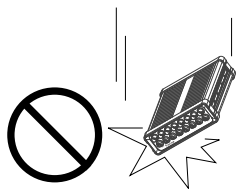
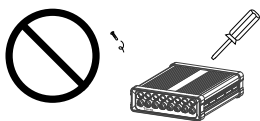

- 切勿在视频服务器中插入任何物体，如针状物等。

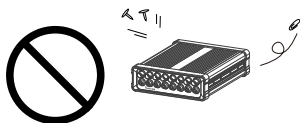

1

检查包装内容

- VS8401 (4路)或VS8801 (8路)

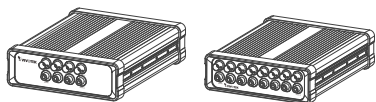

- 电源适配器

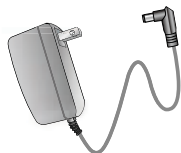

- 软件 CD



- 保修卡



- 快速安装向导



- 一般输入/输出端子台
VS8401: 10 pin x 3个
VS8801: 16 pin x 3个

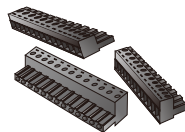

2

物理描述

● VS8801

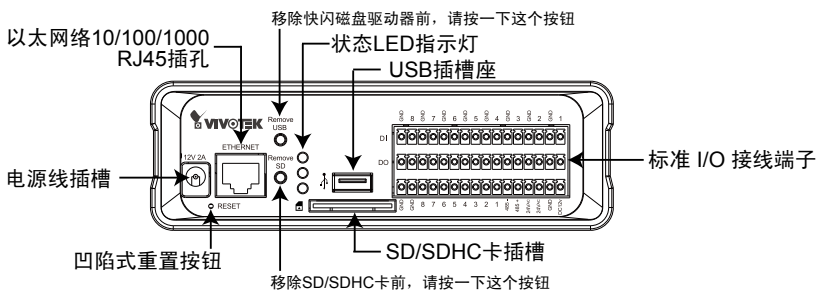
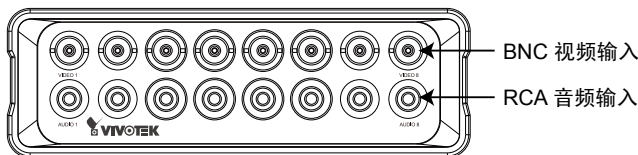

● VS8401

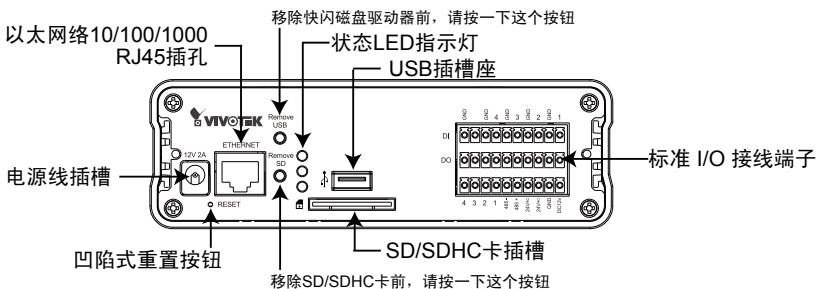
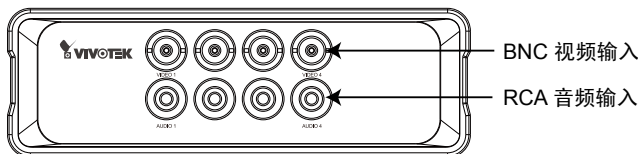

3 网络联机

1. 建立从摄像头的视频连接到BNC视频输入。
2. 建立从 Line-Out 音频源的音频连接到RCA音频输入。

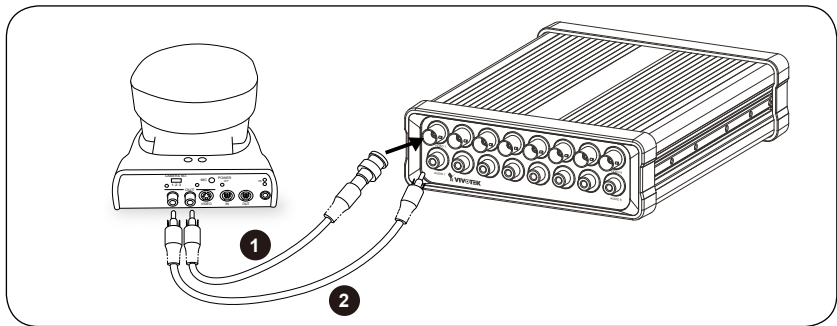

3. 通过以太网线将视频服务器连接到集线器。
4. 将视频服务器随附的电源线连接至电源插座。
5. 如果您有传感器和警报器之类的外部设备，请通过标准 I/O 接线端子进行连接。如需要 pin 的详细定义，请参考下一页的说明。

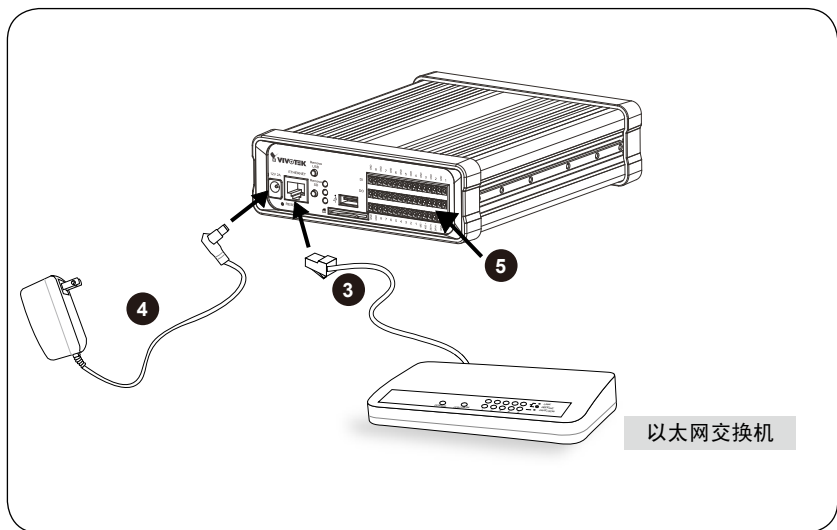

● 一般输入/输出端子台中Pin的定义

VS8801

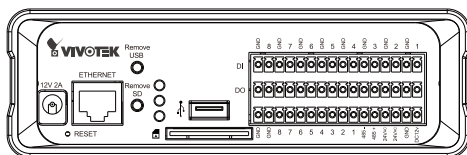

CH 8 GND	CH 8 DI	CH 7 GND	CH 7 DI	CH 6 GND	CH 6 DI	CH 5 GND	CH 5 DI	CH 4 GND	CH 4 DI	CH 3 GND	CH 3 DI	CH 2 GND	CH 2 DI	CH 1 GND	CH 1 DI
CH 8 GND	CH 8 DO	CH 7 GND	CH 7 DO	CH 6 GND	CH 6 DO	CH 5 GND	CH 5 DO	CH 4 GND	CH 4 DO	CH 3 GND	CH 3 DO	CH 2 GND	CH 2 DO	CH 1 GND	CH 1 DO
GND	GND	CH 8 音讯 输出	CH 7 音讯 输出	CH 6 音讯 输出	CH 5 音讯 输出	CH 4 音讯 输出	CH 3 音讯 输出	CH 2 音讯 输出	CH 1 音讯 输出	RS 485-	RS 485+	24V AC	24V AC	GND	DC 12V

VS8401

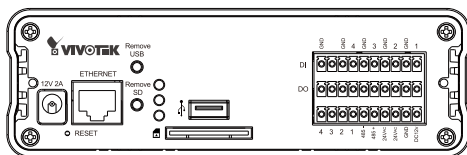

GND	N/A	CH 4 GND	CH 4 DI	CH 3 GND	CH 3 DI	CH 2 GND	CH 2 DI	CH 1 GND	CH 1 DI
GND	N/A	CH 4 GND	CH 4 DO	CH 3 GND	CH 3 DO	CH 2 GND	CH 2 DO	CH 1 GND	CH 1 DO
CH 4 音讯 输出	CH 3 音讯 输出	CH 2 音讯 输出	CH 1 音讯 输出	RS 485-	RS 485+	24V AC	24V AC	GND	DC 12V

1. 运行软件CD中Software Utility (软件实用工具)目录下的“安装向导”。
2. 程序将会对您的网络环境进行分析。分析完网络后，请单击“下一步”按钮以继续运行程序。



3. 程序将搜索同一局域网中的VIVOTEK视频接收器、视频服务器或网络摄像头。
4. 搜索完毕后将弹出主安装窗口。单击与产品底部卷标相对应的MAC序号，将Internet Explorer连接至视频服务器。

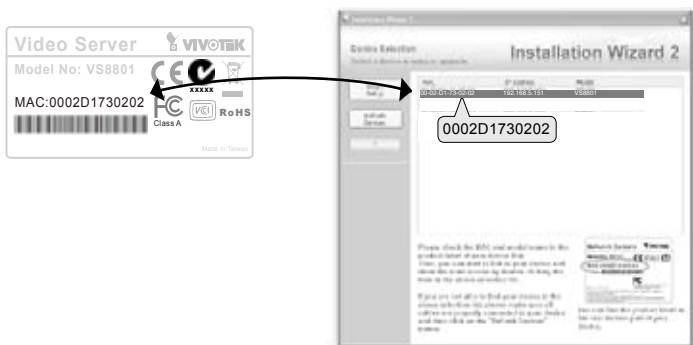

5

准备使用

1. 从网上访问该视频服务器。
2. 通过网络浏览器或录制软件截取视频。



有关摄像头配置的更多信息，请参阅软件CD上的用户指南。



P/N: 625014000G Ver.1.0
Copyright © 2011 VIVOTEK INC. All right reserved.

6F, No.192, Lien-Cheng Rd., Chung-Ho, New Taipei City, Taiwan | T: +886 2 82455282 | F: +886 2 82455532 | E: sales@vivotek.com