



AW-GEV-264A Series

L2 Managed PoE Switch

User Manual

Rev. 1.3

For firmware revision 0116

About This Manual

Copyright

Copyright © 2014 VIVOTEK Inc. All rights reserved.

The products and programs described in this User's Manual are licensed products of VIVOTEK Inc. This User's Manual contains proprietary information protected by copyright, and this User's Manual and all accompanying hardware, software, and documentation are copyrighted. No parts of this User's manual may be copied, photocopied, reproduced, translated or reduced to any electronic medium or machine-readable form by any means by electronic or mechanical, including photocopying, recording, or information storage and retrieval systems, for any purpose other than the purchaser's personal use, and without the prior express written permission of VIVOTEK Inc.

Purpose

This manual gives specific information on how to operate and use the management functions of the AW-GEV-264A

Audience

The Manual is intended for use by network administrators who are responsible for operating and maintaining network equipment; consequently, it assumes a basic working knowledge of general switch functions, the Internet Protocol (IP), and Simple Network Management Protocol (SNMP).

CONVENTIONS

The following conventions are used throughout this manual to show information.

WARRANTY

See the Customer Support/ Warranty booklet included with the product. A copy of the specific warranty terms applicable to your Manufacture products and replacement parts can be obtained from your VIVOTEK Sales and Service Office authorized dealer.

Disclaimer

VIVOTEK Inc. does not warrant that the hardware will work properly in all environments and applications, and marks no warranty and representation, either implied or expressed, with respect to the quality, performance, merchantability, or fitness for a particular purpose. VIVOTEK Inc. disclaims liability for any inaccuracies or omissions that may have occurred. Information in this User's Manual is subject to change without notice and does not represent a commitment on the part of VIVOTEK Inc. VIVOTEK Inc. assumes no responsibility for any inaccuracies that may be contained in this User's Manual. VIVOTEK Inc. makes no commitment to update or keep current the information in this User's Manual, and reserves the right to make improvements to this User's Manual and /or to the products described in this User's Manual, at any time without notice.

FCC Warning

This equipment has been tested and found to comply with the limits for a Class B digital device, pursuant to Part 15 of the FCC Rules. These limits are designed to provide reasonable protection against harmful interference when the equipment is operated in a commercial environment. This equipment generates, uses, and can radiate radio frequency energy and, if not installed and used in accordance with the Instruction manual, may cause harmful interference to radio communications.

FCC Caution

To assure continued compliance (example-use only shielded interface cables when connection to computer or peripheral devices). Any changes or modifications not expressly

approved by the party responsible for compliance could void the user's authority to operate the equipment. This device complies with Part 15 of the FCC Rules. Operation is subject to the following two conditions: (1) This device may not cause harmful interference, and (2) this device must accept any interference received, including interference that may cause undesired operation.

CE mark Warning

This is a Class B device, In a domestic environment, this product may cause radio interference, in which case the user may be required to take adequate measures.



NOTE: Emphasizes important information or calls your attention to related features or instructions.



WARNING: Alerts you to a potential hazard that could cause personal injury.



CAUTION: Alerts you to a potential hazard that could cause loss of data, or damage the system or equipment.

Table of Contents

INTRODUCTION.....	10
CHAPTER 1 HARDWARE INSTALLATION.....	11
CHAPTER 2 OPERATION OF WEB-BASED MANAGEMENT.....	13
CHAPTER 3 SWITCH- SYSTEM CONFIGURATION.....	16
3-1 System	16
3-1.1 Information	16
3-1.2 IP	18
3-1.3 NTP	21
3-1.4 Time	22
3-1.5 Log	25
3-2 Green Ethernet	26
3-3 Ports Configuration	28
3-3.1 Ports.....	28
3-3.2 Ports Description	31
3-4 DHCP.....	32
3-4.1 Server.....	32
3-4.1.1 Mode	32
3-4.1.2 Excluded IP.....	34
3-4.1.3 Pool	35
3-4.2 Snooping	37
3-5 Security.....	39
3-5.1 Switch	39
3-5.1.1 Users.....	39
3-5.1.2 Privilege Level	41
3-5.1.3 Authentication Method.....	43
3-5.1.4 HTTPs.....	44
3-5.1.6 SNMP.....	45
3-5.1.7 RMON.....	59
3-5.2 Network.....	65
3-5.2.1 Limit Control.....	65
3-5.2.2 NAS.....	69
3-5.2.3 ACL	76
3-5.2.4 IP Source Guard	84
3-5.2.5 ARP Inspection	87
3-5.3 AAA	94
3-5.3.1 RADIUS	94
3-6 Aggregation	97
3-6.1 Static	97
3-6.2 LACP	99
3-7 Loop Protection	101
3-8 Spanning Tree	103
3-8.1 Bridge Setting.....	103
3-8.2 MSTI Mapping.....	106

3-8.3 MSTI Priorities.....	108
3-8.4 CIST Ports.....	109
3-8.5 MSTI Ports.....	112
3-9 IPMC.....	114
3-9.1 IGMP Snooping.....	114
3-9.1.1 Basic Configuration.....	114
3-9.1.2 VLAN Configuration.....	116
3-10 LLDP.....	118
3-10.1 LLDP Configuration.....	118
3-10.2 LLDP-MED Configuration.....	121
3- 11 PoE.....	127
3- 11.1 Configuration.....	127
3- 11.2 Power Delay.....	130
3- 11.3 Scheduling.....	131
3- 11.4 Auto Checking.....	133
3-12 MAC Table.....	135
3-13 VLANs.....	137
3-14 Private VLANs.....	141
3-14.1 VLAN Membership.....	141
3-14.2 Port Isolation.....	143
3-15 VCL.....	144
3-15.1 MAC-based VLAN.....	144
3-15.2 Protocol -based VLAN.....	146
3-15.2.1 Protocol to Group.....	146
3-15.2.2 Group to VLAN.....	148
3-15.3 IP Subnet-based VLAN.....	149
3-16 VOICE VLAN.....	151
3-16.1 Configuration.....	151
3-16.2 OUI.....	153
3-17 QoS.....	154
3-17.1 Port Classification.....	154
3-17.2 Port Policing.....	157
3-17.4 Port Schedulers.....	159
3-17.5 Port Shaping.....	162
3-17.6 Port Tag Remarking.....	165
3-17.7 Port DSCP.....	168
3-17.8 DSCP-Based QoS.....	170
3-17.9 DSCP Translation.....	172
3-17.10 DSCP Classification.....	174
3-17.11 QoS Control List Configuration.....	176
3-17.12 Storm Control.....	181
3-18 Mirror.....	182
3-19 UPnP.....	184
CHAPTER 4. SWITCH- MONITOR.....	186
4-1 System.....	186
4-1.1 Information.....	186

4-1.2 IP Status	188
4-1.3 Log	190
4-1.4 Detailed Log	192
4-2 Green Ethernet	193
4-2.1 Port Power Savings	193
4-3 Ports	194
4-3.1 Traffic Overview	194
4-3.2 Qos Statistics.....	196
4-3.3 QCL Status.....	198
4-3.4 Detailed Statistics.....	200
4-4 DHCP.....	203
4-4.1 Server.....	203
4-4.1.1 Statistics	203
4-4.1.2 Binding.....	204
4-4.1.3 Declined IP.....	205
4-4.2 Snooping Table.....	206
4-4.3 Detailed Statistics.....	207
4-5 Security.....	209
4-5.1 Network	209
4-5.1.1 Port Security	209
4-5.1.2 NAS	214
4-5.1.3 ARP Inspection	221
4-5.1.4 IP Source Guard	222
4-5.2 AAA	224
4-5.2.1 RADIUS Overview	224
4-5.2.2 RADIUS Details.....	226
4-5.3 Switch	231
4-5.3.1 RMON.....	231
4-6 LACP.....	239
4-6.1 System Status.....	239
4-6.3 Port Statistics	242
4-7 Loop Protection	244
4-8 Spanning Tree	245
4-8.1 Bridge Status.....	245
4-8.2 Port Status	246
4-8.3 Port Statistics	247
4-9 IPMC	248
4-9.1 IGMP Snooping	248
4-9.1.1 Status.....	248
4-9.1.2 Group Information	250
4-10 LLDP.....	252
4-10.1 Neighbour	252
4-11 PoE.....	263
4-12 MAC Table.....	265
4-13 VLANs	267
4-13.1 VLAN Membership.....	267
4-13.2 VLAN Port.....	269

4-14 VCL	271
4-14.1 MAC-based VLAN	271
4-14.2 Protocol-based VLAN	272
4-14.2.1 Protocol to Group.....	272
4-14.2.2 Group to VLAN.....	274
4-14.3 IP Subnet-based VLAN	275
CHAPTER 5. SWITCH- DIAGNOSTICS	276
5-1 Ping	276
5-2 Ping6	278
5-3 VeriPHY	280
5-4 Traceroute	282
CHAPTER 6 SWITCH- MAINTENANCE	283
6-1 Restart Device	283
6-2 Factory Defaults	284
6-3 Firmware	285
6-3.1 Download.....	285
6-3.2 Software Image Select	286
6-4 Configuration	288
6-4.1 Save startup-config	288
6-4.2 Upload	289
6-4.3 Download.....	290
6-4.5 Delete.....	292
CHAPTER 7 SURVEILLANCE - MANAGEMENT	293
7-1 Information	294
7-2 Time	298
7-3 VVTK NVR & CMS	300
7-4 VVTK Camera & Encoder	302
7-5 Camera Upgrade	305
7-6 Camera Configure	306
7-6.1 Config Export	306
7-6.2 Config Import.....	307
7-6.3 Config Files.....	308
7-7 VVTK Switch	308
7-8 IP Device	308
7-8.1 NVR & CMS	309
7-8.2 Camera & Encoder	309
7-8.3 Other Device.....	310

Note that if the Auto-refresh checkbox is selected, the device status is refreshed

by every 3 seconds. If you want to Remove a detected device, deselect the Auto-refresh checkbox first.

7-9 Un-managed Devices	311
7-9.1 IP Device	311
CHAPTER 8 SURVEILLANCE - GRAPHIC VIEW	314
8-1 Topology View	314
8-4 Google Map	326
CHAPTER 9 SURVEILLANCE - NETWORK	328
9-1 Security.....	328
9-2 Grouping.....	329
CHAPTER 10 SURVEILLANCE - MONITOR.....	331
10-1 Traffic Chart	331
10-2 <i>INSTANT THROUGHPUT</i>	332
CHAPTER 11 SURVEILLANCE - DIAGNOSTICS.....	333
11-1 Device Status	333
CHAPTER 12 SURVEILLANCE - MAINTENANCE.....	334
12-1 Device info to CSV	334
12-2 Surveillance Config.....	334

Revision History

Date	Revision	Description
10/15/2014	1.0	Initial release
3/18/2015	1.1	Added description for the re-arranged Surveillance functional menus.
8/10/2015	1.2	Added description for the following: <ol style="list-style-type: none"> 1. Added switch as an Auto discovery device type for configuration in a deployment involving multiple surveillance switches. 2. Up to 1,024 devices in the device scan range. 3. Supports Automatic and Manual modes in device scan. 4. Supports JPG/PDF/SVG export configuration file formats in Topology View. 5. Supports JPG/PDF/SVG export file formats in the Floor View. 6. Added Live Stream in devices' quick access menu in the Topology View/Floor Map/Google Map windows. 7. Added quick access menu in the Floor view and Google Map windows. 8. Supports up to 20x Floor maps. 9. Added GPS data for the Google map location. 10. "Save disk" will preserve both surveillance and switch configurations. 11. Added the display of Instant Throughput. 12. Supports switch event notification via Emails.
3/21/2016	1.3	Added description for the following: <ol style="list-style-type: none"> 1. Added Voice VLAN function in Switch UI 2. Changed Surveillance item list 3. IP device add manually sorting 3. Topology view - added zooming function 4. Topology view - display device info and changed the support info.

 **NOTE:**

For users who use this switch in a surveillance application, you can go directly to Chapter 7 through Chapter 12 for information directly related to surveillance deployments.

INTRODUCTION

Overview

This user's manual provides installation and configuration details through a web console (via the RJ-45 Ethernet connection).

The AW-GEV-264A series, the next generation L2 SNMP managed PoE switch, is a portfolio of affordable managed switches that provides a reliable infrastructure for your business network. These switches deliver more intelligent features and improve the availability of your critical business applications, protect your sensitive information, and optimize your network bandwidth to deliver information and applications more effectively. It provides the ideal combination of affordability and capabilities for entry level networking including small business or enterprise applications and helps you create a more efficient workforce.

The AW-GEV-264 L2 SNMP managed switch provides 26 ports in a single device; the specifications are highlighted as follows.

- L2+ features provide better manageability, security, QoS, and performance.
- Support IPv4/IPv6 dual stack management
- Support SSH/SSL secured management
- Support SNMP v1/v2c/v3
- Support RMON groups 1,2,3,9
- Support IGMP v1/v2/v3 Snooping
- Support RADIUS authentication
- Support IP Source Guard
- Support DHCP Snooping
- Support ACL and QCL for traffic filtering
- Support 802.1d(STP), 802.1w(RSTP) and 802.1s(MSTP)
- Support LACP and static link aggregation
- Support Q-in-Q double tag VLAN

Overview of this user's manual

- Chapter 1 "Hardware Installation"
- Chapter 2 "Operation of Web-based Management"
- Chapter 3 "System Configuration"
- Chapter 4 "Configuration"
- Chapter 5 "Security"
- Chapter 6 "Maintenance"
- Chapter 7 "Surveillance Management" (Surveillance users can start from this chapter)
- Chapter 8 "Surveillance Graphic View"
- Chapter 9 "Surveillance Network"
- Chapter 10 "Surveillance Monitor"
- Chapter 11 "Surveillance Diagnostics"
- Chapter 12 "Surveillance Maintenance"

Chapter 1

Hardware Installation

Package Contents

1x PoE switch	1x Quick Installation Guide
2x rack mount ears	1x power cord (type by the shipped-to area)
1x CD-ROM	

LED Definitions

System	Green ON	Lit when power is on and normal. Off when power is disconnected.	
Link/ACT/Speed	Green	Lit Green when displaying Link/ACT/Speed status of Ethernet ports (selected by the Mode button)	
PoE	Green	Lit Green when displaying the PoE link status with powered devices.	
Below are the LEDs below the Ethernet and SFP ports:			
Ethernet port LED	TP Speed	Green /Yellow	Green when TP link is on 1000Mbps Yellow when TP link is on 10/100Mbps
	PoE (Link/ACT)	Green	Green when PoE linked with powered device and supplying power to them.
SFP speed	Green/Yellow	Green when SFP link is on 1Gbps Yellow when SFP link is on 100Mbps	

Connections

Front Panel

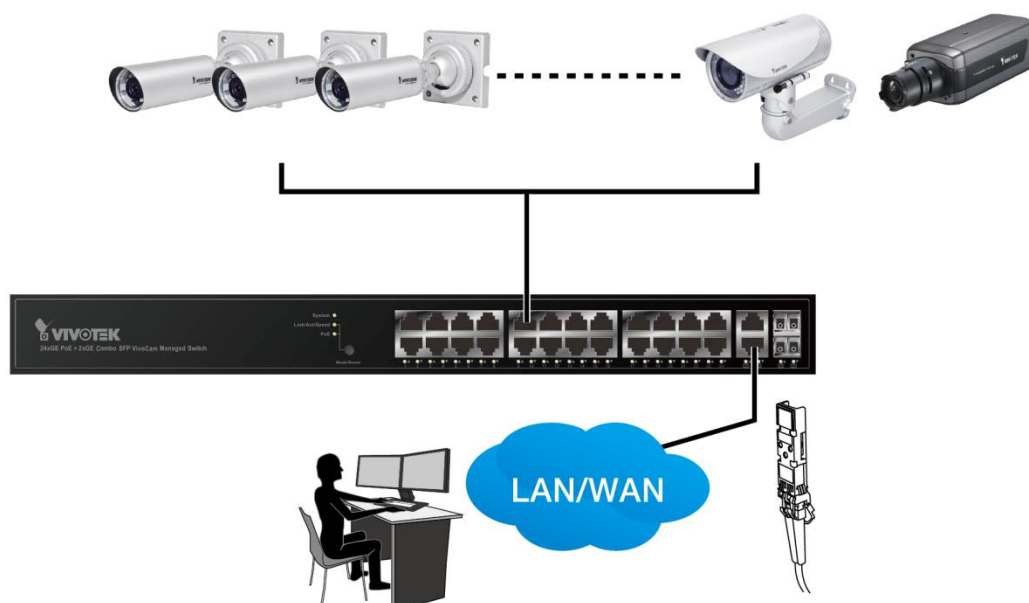

Rear Panel



Rack Mounting

Front rack posts

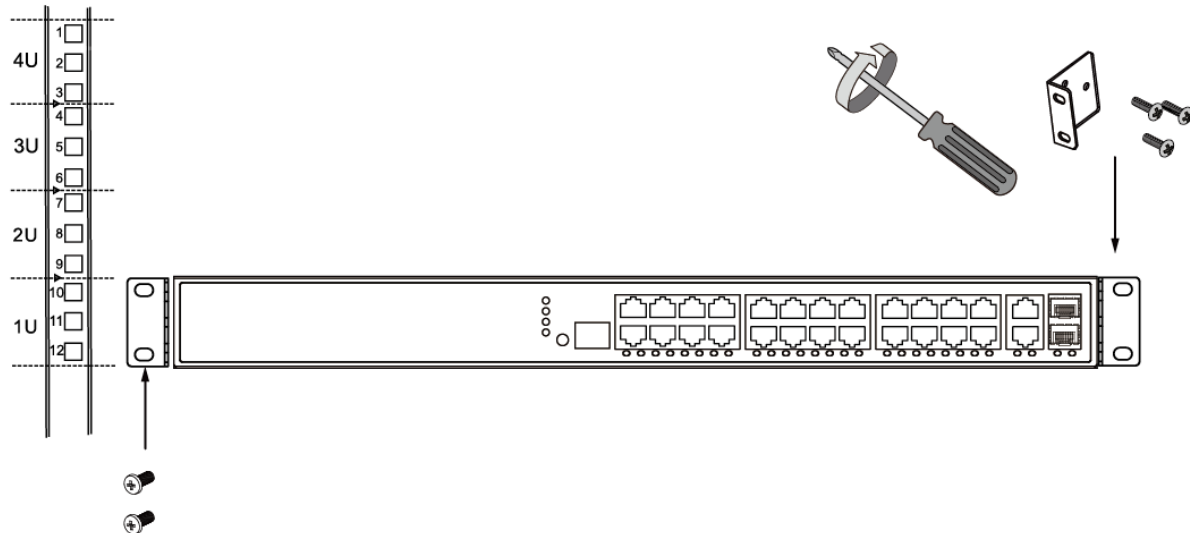

Hardware Reset / Mode Button

The reset button is used to reboot the PoE switch or to restore the factory default settings. Sometimes resetting the system can return the PoE switch to normal operation. If the system problems remain after reset, restore the factory settings and try again.

Reboot: Press 3~10 seconds and release the recessed reset button. Wait for the PoE Switch to reboot.

Reset to factory default: Press >10 seconds and release the recessed reset button. Wait for the PoE Switch to reset to factory default & Reboot.

The mode button is use to switch LED indicator's mode.

Link / ACT/ Speed: Press <3 seconds and release the recessed mode button. The Link / ACT/ Speed LED will on. Green when displaying Link/ACT/Speed status of Ethernet ports.

PoE : Press <3 seconds and release the recessed mode button. The PoE LED will on. Green when displaying the PoE link status with powered devices.

Chapter 2 Operation of Web-based Management

Initial Configuration

IMPORTANT:

1. It is recommended to use **IE10** or **IE11** to open a web console with the PoE switch.
2. This PoE switch is specifically designed for surveillance applications. It comes with an integrated Surveillance interface for ease of configuration. The Surveillance interface is accessed through a tabbed menu, and the configuration changes made in its window have a higher priority than those in the Switch configuration menus.

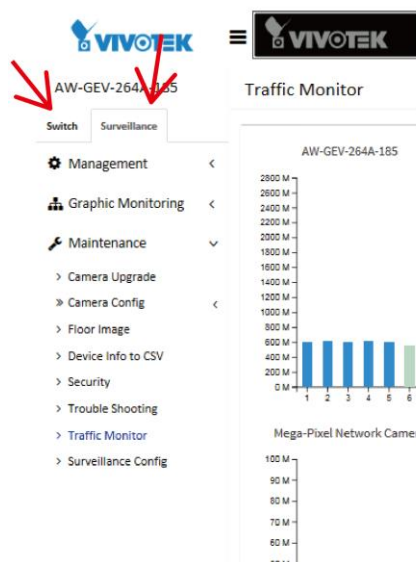

3. You should save the configuration changes made on the Surveillance menus before leaving the web page. Otherwise, your configuration changes will be lost. The save button is located on the upper right corner of the screen.

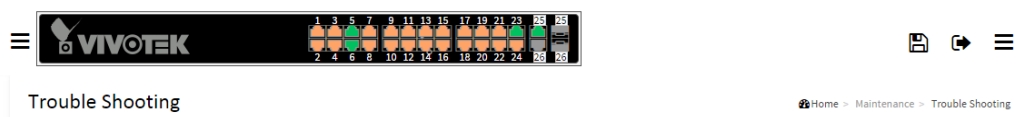

This chapter instructs you how to configure and manage the AW-GEV-264A through the web user interface. With this facility, you can easily access and monitor through any one port of the switch all the status of the switch, including MIBs status, each port activity, Spanning tree status, port aggregation status, multicast traffic, VLAN and priority status, even illegal access record and so on.

The default values of the AW-GEV-264A are listed in the table below:

IP Address	DHCP client
Subnet Mask	255.255.255.0
Default Gateway	N/A
Username	admin

Password	admin
----------	-------

You can find the PoE switch using VIVOTEK's IW2 utility. If network address conflicts occur, use this utility to locate the PoE switch.

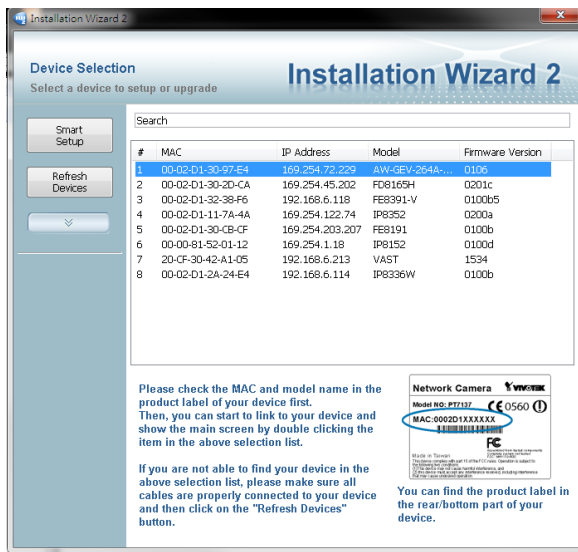

If you double-click on the entry found on the IW2 utility, an IE console will be opened. If you prefer using Firefox or Google Chrome, you can manually enter the IP address in your browser's URL field.

If you enabled the onboard DHCP server on the PoE switch, you can browse it. For instance, type <http://192.168.1.1> in the address row in a browser, it will display the following screen and ask you to enter a username and password in order to login and access authentication.

The default username is **"admin"** and password is **admin**. For the first time to use, please enter the default username and password, and then click the **<Login>** button. The login process now is completed. In this login menu, you have to input the complete username and password respectively, the AW-GEV-264A will not give you a shortcut to username automatically. This looks inconvenient, but safer.

The AW-GEV-264A allows two or more users to manage the switch using the administrator's identity. The configuration changes made will take effect depending on who made the last configuration change.

Figure 1 The login page

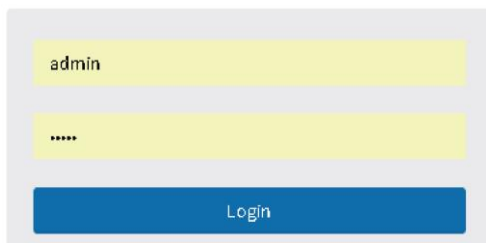



NOTE:

When you login the Switch WEB/CLI to manager. You must first type the Username of the admin. Use "admin" as the default password, so when you type after the end Username, please press enter. Management page to enter WEB/CLI.

When you login the PoE switch series Web UI management, you can use both ipv4 ipv6 login to manage

To optimize the display effect, we recommend you using the below browser and OS combinations:

	Chrome after v.39	Chrome Before v38	FireFox v.39	IE11	IE10	IE9	IE8
WinXP	No	Yes	Yes	---	---	---	No
Win7	No	Yes	Yes	Yes	Yes	No	No
Win8/8.1	No	Yes	Yes	Yes	Yes	No	No



NOTE:

The PoE switch and all cameras attached must be configured in the same subnet. Otherwise, the Surveillance-related functions will not apply. You can let the PoE switch be a DHCP client (listening to a DHCP server for IP assignment), or enable its onboard DHCP server.

Chapter 3

Switch- System Configuration

This chapter describes the entire basic configuration tasks which includes the System Information and any manage of the Switch (e.g. Time, Account, IP, Syslog and NTP.)

3-1 System

You can identify the system by configuring the contact information, name, and location of the switch.

3-1.1 Information

The switch system's contact information is provided here.

Web interface

To configure System Information in the web interface:

1. Click Configuration, System, and Information.
2. Write System Contact, System Name, System Location information in this page.
3. Click Apply.

Figure 3-1.1: System Information

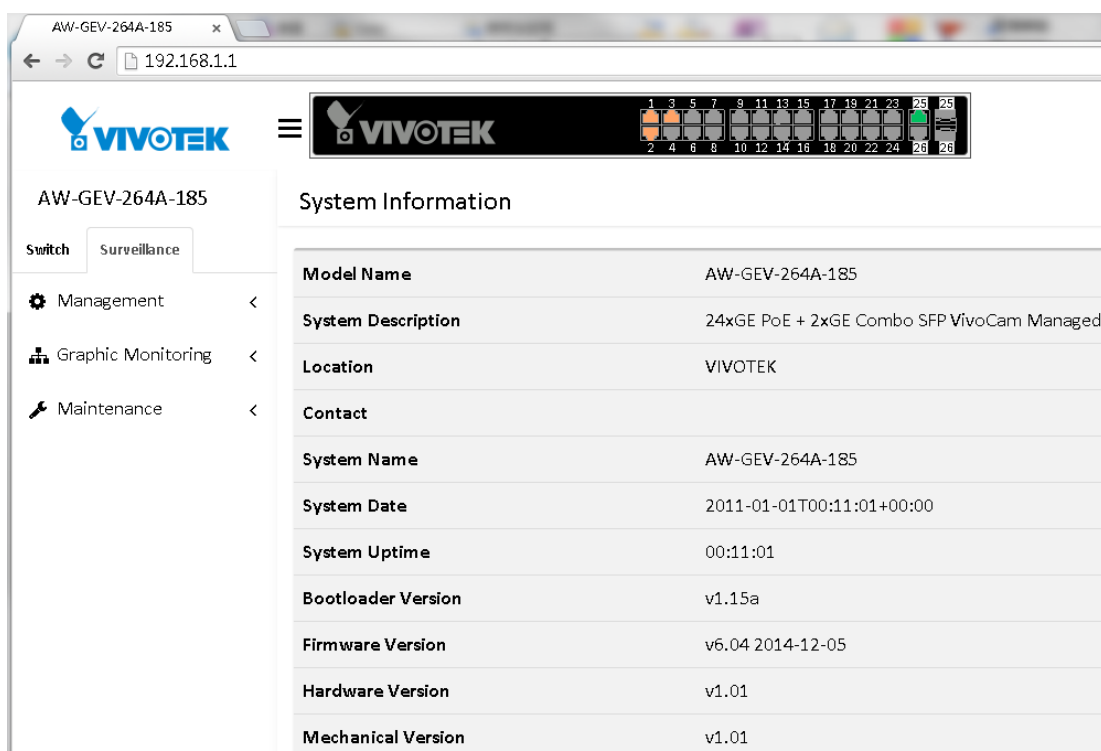

Model Name	AW-GEV-264A-185
System Description	24xGE PoE + 2xGE Combo SFP VivoCam Managed S
Location	VIVOTEK
Contact	
System Name	AW-GEV-264A-185
System Date	2011-01-01T00:11:01+00:00
System Uptime	00:11:01
Bootloader Version	v1.15a
Firmware Version	v6.04 2014-12-05
Hardware Version	v1.01
Mechanical Version	v1.01

Parameter description:

- **System Contact:**

The textual identification of the contact person for this managed node, together with information on how to contact this person. The allowed string length is 0 to 128, and the allowed content is the ASCII characters from 32 to 126.

- **System name:**

An administratively assigned name for this managed node. By convention, this is the node's fully-qualified domain name. A domain name is a text string drawn from the alphabet (A-Za-z), digits (0-9), minus sign (-). No space characters are permitted as part of a name. The first character must be an alpha character. And the first or last character must not be a minus sign. The allowed string length is 0 to 128.

- **System Location:**

The physical location of this node(e.g., telephone closet, 3rd floor). The allowed string length is 0 to 128, and the allowed content is the ASCII characters from 32 to 126.

3-1.2 IP

The IPv4 address for the switch could be obtained via DHCP Server for VLAN 1. To manually configure an address, you need to change the switch's default settings to values that are compatible with your network. You may also need to establish a default gateway between the switch and management stations that exist on another network segment.

Configure the switch-managed IP information on this page

Configure IP basic settings, control IP interfaces and IP routes.

The maximum number of interfaces supported is 8 and the maximum number of routes is 32.

Web Interface

To configure an IP address in the web interface:

1. Click Configuration, System, IP.
2. Click Add Interface then you can create new Interface on the switch.
3. Click Add Route then you can create new Route on the switch
4. Click Apply

Figure 3-1.2: The IP configuration

IP Configuration
Home > Configuration > System > IP

Mode	Host <input type="button" value="v"/>
DNS Server	Configured <input type="button" value="v"/> 168.95.1.1
DNS Proxy	<input type="checkbox"/>

IP Interfaces

Delete	VLAN	IPv4 DHCP			IPv4		IPv6	
		Enable	Fallback	Current Lease	Address	Mask Length	Address	Mask Length
<input type="checkbox"/>	1	<input type="checkbox"/>	0		192.168.1.1	24		

IP Routes

Delete	Network	Mask Length	Gateway	Next Hop VLAN
<input type="checkbox"/>	0.0.0.0	0	192.168.1.254	0
	192.168.1.0	24	192.168.1.1	0

Parameter description:

IP Configuration

● **Mode:**

Configure whether the IP stack should act as a Host or a Router. In Host mode, IP traffic between interfaces will not be routed. In Router mode traffic is routed between all interfaces.

● **DNS Server**

This setting controls the DNS name resolution done by the switch. The following modes are supported:

- From any DHCP interfaces
The first DNS server offered from a DHCP lease to a DHCP-enabled interface will be used.
- No DNS server
No DNS server will be used.
- Configured
Explicitly provide the IP address of the DNS Server in dotted decimal notation.
- From this DHCP interface
Specify from which DHCP-enabled interface a provided DNS server should be preferred.

● **DNS Proxy**

When DNS proxy is enabled, system will relay DNS requests to the currently configured DNS server, and reply as a DNS resolver to the client devices on the network.

IP Interfaces

● **Delete**

Select this option to delete an existing IP interface.

● **VLAN**

The VLAN associated with the IP interface. Only ports in this VLAN will be able to access the IP interface. This field is only available for input when creating a new interface.

● **IPv4 DHCP Enabled**

Enable the DHCP client by checking this box. If this option is enabled, the system will configure the IPv4 address and mask of the interface using the DHCP protocol. The DHCP client will announce the configured System Name as hostname to provide DNS lookup.

● **IPv4 DHCP Fallback Timeout**

The number of seconds for trying to obtain a DHCP lease. After this period expires, a configured IPv4 address will be used as IPv4 interface address. A value of zero disables the fallback mechanism, such that DHCP will keep retrying until a valid lease is obtained. Legal values are 0 to 4294967295 seconds.

● **IPv4 DHCP Current Lease**

For DHCP interfaces with an active lease, this column show the current interface address, as provided by the DHCP server.

● **IPv4 Address**

The IPv4 address of the interface in dotted decimal notation.
If DHCP is enabled, this field is not used. The field may also be left blank if IPv4 operation on the interface is not desired.

● **IPv4 Mask**

The IPv4 network mask, in number of bits (prefix length). Valid values are between 0 and 30 bits for a IPv4 address.
If DHCP is enabled, this field is not used. The field may also be left blank if IPv4 operation on the interface is not desired.

● **IPv6 Address**

The IPv6 address of the interface. A IPv6 address is in 128-bit records represented as eight fields of up to four hexadecimal digits with a colon separating each field (:). For example, fe80::215:c5ff:fe03:4dc7. The symbol :: is a special syntax that can be used as a shorthand way of representing multiple 16-bit groups of contiguous zeros; but it can appear only once. It can also represent a legally valid IPv4 address. For example, ::192.1.2.34. The field may be left blank if IPv6 operation on the interface is not desired.

- **IPv6 Mask**

The IPv6 network mask, in number of bits (prefix length). Valid values are between 1 and 128 bits for a IPv6 address.

The field may be left blank if IPv6 operation on the interface is not desired.

IP Routes

- **Delete**

Select this option to delete an existing IP route.

- **Network**

The destination IP network or host address of this route. Valid format is dotted decimal notation or a valid IPv6 notation. A default route can use the value 0.0.0.0 or IPv6 :: notation.

- **Mask Length**

The destination IP network or host mask, in number of bits (prefix length). It defines how much of a network address that must match, in order to qualify for this route. Valid values are between 0 and 32 bits respectively 128 for IPv6 routes. Only a default route will have a mask length of 0 (as it will match anything).

- **Gateway**

The IP address of the IP gateway. Valid format is dotted decimal notation or a valid IPv6 notation. Gateway and Network must be of the same type.

- **Next Hop VLAN (Only for IPv6)**

The VLAN ID (VID) of the specific IPv6 interface associated with the gateway.

The given VID ranges from 1 to 4094 and will be effective only when the corresponding IPv6 interface is valid.

If the IPv6 gateway address is link-local, it must specify the next hop VLAN for the gateway.

If the IPv6 gateway address is not link-local, system ignores the next hop VLAN for the gateway.

Buttons

- **Add Interface:**

Click to add a new IP interface. A maximum of 8 interfaces is supported.

- **Add Route:**

Click to add a new IP route. A maximum of 32 routes is supported.

- **Apply:**

Click to save changes.

- **Reset:**

Click to undo any changes made locally and revert to previously saved values.

3-1.3 NTP

NTP is Network Time Protocol and is used to sync the network time based Greenwich Mean Time (GMT). If use the NTP mode and select a built-in NTP time server or manually specify an user-defined NTP server as well as Time Zone, the switch will sync the time in a short after pressing <Apply> button. Though it synchronizes the time automatically, the precondition is that the switch must have the access to Internet.

Time Zone is an offset time off GMT. You have to select the time zone first and then perform time sync via NTP because the switch will combine this time zone offset and updated NTP time to come out the local time, otherwise, you will not able to get the correct time. The switch supports configurable time zone from -12 to +13 step 1 hour.

Default Time zone: +8 Hrs.

Web Interface

To configure NTP in the web interface:

1. Click Configuration, System, NTP.
2. Specify the Time parameter in manual parameters.
3. Click Apply.

Figure 3-1.3: The NTP configuration

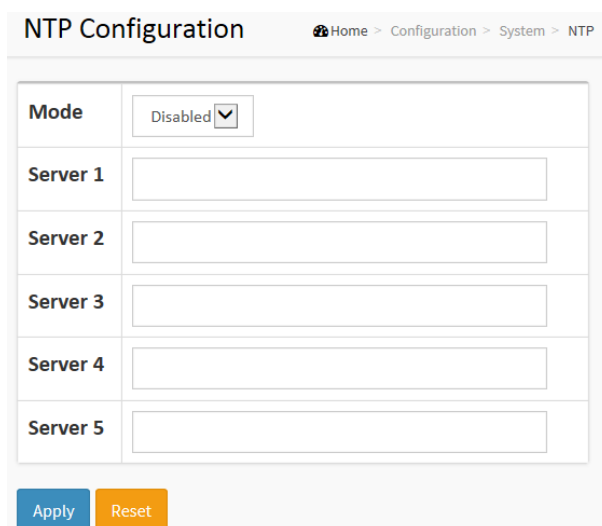

NTP Configuration	
Home > Configuration > System > NTP	
Mode	Disabled ▾
Server 1	<input type="text"/>
Server 2	<input type="text"/>
Server 3	<input type="text"/>
Server 4	<input type="text"/>
Server 5	<input type="text"/>
<input type="button" value="Apply"/> <input type="button" value="Reset"/>	

Parameter description:

- **Mode :**

Indicates the NTP mode operation. Possible modes are:

Enabled: Enable NTP client mode operation.

Disabled: Disable NTP client mode operation.

- **Server 1 to 5 :**

Provide the NTP IPv4 or IPv6 address of this switch. IPv6 address is in 128-bit records represented as eight fields of up to four hexadecimal digits with a colon separating each field (:). For example, 'fe80::215:c5ff:fe03:4dc7'. The symbol '::' is a special syntax that can be used as a shorthand way of representing multiple 16-bit groups of contiguous zeros; but it can only appear once. It can also represent a legally valid IPv4 address. For example, ':::192.1.2.34'.

- **Buttons**

These buttons are displayed on the NTP page:

Apply – Click to save changes.

Reset - Click to undo any changes made locally and revert to previously saved values.

3-1.4 Time

The switch provides manual and automatic ways to set the system time via NTP. Manual setting is simple and you just input “Year”, “Month”, “Day”, “Hour” and “Minute” within the valid value range indicated in each item.

Web Interface

To configure Time in the web interface:

1. Click Configuration, System and Time
2. Specify the Time parameter.
3. Click Apply.

Figure 3-1.4: The time configuration

Time Configuration	
Time Configuration	
Clock Source	Use Local Settings <input type="button" value="v"/>
System Date	2011-01-01 01:04:59 (yyyy-mm-dd hh:mm:ss)
Time Zone Configuration	
Time Zone	None <input type="button" value="v"/>
Acronym	<input type="text"/> (0 - 16 characters)

Daylight Saving Time Configuration	
Daylight Saving Time	Disabled <input type="button" value="v"/>
Start Time settings	
Month	Jan <input type="button" value="v"/>
Date	1 <input type="button" value="v"/>
Year	2000 <input type="button" value="v"/>
Hours	0 <input type="button" value="v"/>
Minutes	0 <input type="button" value="v"/>
End Time settings	
Month	Jan <input type="button" value="v"/>
Date	1 <input type="button" value="v"/>
Year	2000 <input type="button" value="v"/>
Hours	0 <input type="button" value="v"/>
Minutes	0 <input type="button" value="v"/>
Offset settings	
Offset	1 <input type="text"/> (1 - 1440) Minutes
<input type="button" value="Apply"/> <input type="button" value="Reset"/>	

Parameter description:

Time Configuration

- **Clock Source:**

There are two modes for configuring how the Clock Source from. Select "Use Local Settings" : Clock Source from Local Time. Select "Use NTP Server" : Clock Source from NTP Server.

- **System Date:**

Show the current time of the system. The year of system date limits between 2011 and 2037.

Time Zone Configuration

- **Time Zone:**

Lists various Time Zones world wide. Select appropriate Time Zone from the drop down and click Apply to set.

- **Acronym:**

User can set the acronym of the time zone. This is a User configurable acronym to identify the time zone. (Range : Up to 16 characters)

Daylight Saving Time Configuration

- **Daylight Saving Time:**

This is used to set the clock forward or backward according to the configurations set below for a defined Daylight Saving Time duration. Select 'Disable' to disable the Daylight Saving Time configuration. Select 'Recurring' and configure the Daylight Saving Time duration to repeat the configuration every year. Select 'Non-Recurring' and configure the Daylight Saving Time duration for single time configuration. (Default : Disabled).

Recurring Configuration

- **Start time settings:**

Week - Select the starting week number.

Day - Select the starting day.

Month - Select the starting month.

Hours - Select the starting hour.

Minutes - Select the starting minute.

- **End time settings:**

Week - Select the ending week number.

Day - Select the ending day.

Month - Select the ending month.

Hours - Select the ending hour.

Minutes - Select the ending minute.

- **Offset settings:**

Offset - Enter the number of minutes to add during Daylight Saving Time. (Range: 1 to 1440)



NOTE: The under "Start Time Settings" and "End Time Settings" was displayed what you set on the "Start Time Settings" and "End Time Settings" field information.

- **Buttons**

These buttons are displayed on the NTP page:

Apply - Click to save changes.

Reset - Click to undo any changes made locally and revert to previously saved values.

3-1.5 Log

The log is a standard for logging program messages . It allows separation of the software that generates messages from the system that stores them and the software that reports and analyzes them. It can be used as well a generalized informational, analysis and debugging messages. It is supported by a wide variety of devices and receivers across multiple platforms.

Web Interface

To configure log configuration in the web interface:

1. Click Configuration, System and log.
2. Specify the syslog parameters include IP Address of Syslog server and Port number.
3. Evoke the Syslog to enable it.
4. Click Apply.

Figure 3-1.5: The System Log configuration

System Log Configuration Home > Configuration > System > Log

Server Mode	Disabled <input type="button" value="v"/>
Server Address	<input type="text"/>

Parameter description:

- **Server Mode :**

Indicate the server mode operation. When the mode operation is enabled, the syslog message will send out to syslog server. The syslog protocol is based on UDP communication and received on UDP port 514 and the syslog server will not send acknowledgments back sender since UDP is a connectionless protocol and it does not provide acknowledgments. The syslog packet will always send out even if the syslog server does not exist. Possible modes are:

Enabled: Enable server mode operation.

Disabled: Disable server mode operation.

- **Server Address :**

Indicates the IPv4 hosts address of syslog server. If the switch provide DNS feature, it also can be a host name.

- **Syslog Level :**

Indicates what kind of message will send to syslog server. Possible modes are:

Info: Send information, warnings and errors.

Warning: Send warnings and errors.

Error: Send errors.

- **Buttons**

These buttons are displayed on the NTP page:

Apply – Click to save changes.

Reset - Click to undo any changes made locally and revert to previously saved values.

3-2 Green Ethernet

EEE is a power saving option that reduces the power usage when there is low or no traffic utilization.

EEE works by powering down circuits when there is no traffic. When a port gets data to be transmitted all circuits are powered up. The time it takes to power up the circuits is named wakeup time. The default wakeup time is 17 us for 1Gbit links and 30 us for other link speeds. EEE devices must agree upon the value of the wakeup time in order to make sure that both the receiving and transmitting device has all circuits powered up when traffic is transmitted. The devices can exchange wakeup time information using the LLDP protocol.

EEE works for ports in auto-negotiation mode, where the port is negotiated to either 1G or 100 Mbit full duplex mode.

For ports that are not EEE-capable the corresponding EEE checkboxes are grayed out and thus impossible to enable EEE for.

When a port is powered down for saving power, outgoing traffic is stored in a buffer until the port is powered up again. Because there are some overhead in turning the port down and up, more power can be saved if the traffic can be buffered up until a large burst of traffic can be transmitted. Buffering traffic will give some latency in the traffic.

Web Interface

To configure a Port Power Saving Configuration in the web interface:

1. Click Configuration, Green Ethernet
2. Evoke to enable or disable the ActiPHY, PerfectReach, EEE and EEE Urgent Queues .
3. Click Apply.

Figure 3-2.1: The Port Power Saving Configuration

Port Power Savings Configuration
Home > Configuration > Green Ethernet > Port Power Savings

Optimize EEE for
Latency

Port Configuration

Port	ActiPHY	PerfectReach	EEE	EEE Urgent Queues								
				1	2	3	4	5	6	7	8	
*	<input type="checkbox"/>	<input type="checkbox"/>	<input type="checkbox"/>	<input type="checkbox"/>	<input type="checkbox"/>	<input type="checkbox"/>	<input type="checkbox"/>	<input type="checkbox"/>	<input type="checkbox"/>	<input type="checkbox"/>	<input type="checkbox"/>	<input type="checkbox"/>
1	<input type="checkbox"/>	<input type="checkbox"/>	<input type="checkbox"/>	<input type="checkbox"/>	<input type="checkbox"/>	<input type="checkbox"/>	<input type="checkbox"/>	<input type="checkbox"/>	<input type="checkbox"/>	<input type="checkbox"/>	<input type="checkbox"/>	<input type="checkbox"/>
2	<input type="checkbox"/>	<input type="checkbox"/>	<input type="checkbox"/>	<input type="checkbox"/>	<input type="checkbox"/>	<input type="checkbox"/>	<input type="checkbox"/>	<input type="checkbox"/>	<input type="checkbox"/>	<input type="checkbox"/>	<input type="checkbox"/>	<input type="checkbox"/>
3	<input type="checkbox"/>	<input type="checkbox"/>	<input type="checkbox"/>	<input type="checkbox"/>	<input type="checkbox"/>	<input type="checkbox"/>	<input type="checkbox"/>	<input type="checkbox"/>	<input type="checkbox"/>	<input type="checkbox"/>	<input type="checkbox"/>	<input type="checkbox"/>

23	<input type="checkbox"/>	<input type="checkbox"/>	<input type="checkbox"/>	<input type="checkbox"/>	<input type="checkbox"/>	<input type="checkbox"/>	<input type="checkbox"/>	<input type="checkbox"/>	<input type="checkbox"/>	<input type="checkbox"/>	<input type="checkbox"/>
24	<input type="checkbox"/>	<input type="checkbox"/>	<input type="checkbox"/>	<input type="checkbox"/>	<input type="checkbox"/>	<input type="checkbox"/>	<input type="checkbox"/>	<input type="checkbox"/>	<input type="checkbox"/>	<input type="checkbox"/>	<input type="checkbox"/>
25	<input type="checkbox"/>	<input type="checkbox"/>	<input type="checkbox"/>	<input type="checkbox"/>	<input type="checkbox"/>	<input type="checkbox"/>	<input type="checkbox"/>	<input type="checkbox"/>	<input type="checkbox"/>	<input type="checkbox"/>	<input type="checkbox"/>
26	<input type="checkbox"/>	<input type="checkbox"/>	<input type="checkbox"/>	<input type="checkbox"/>	<input type="checkbox"/>	<input type="checkbox"/>	<input type="checkbox"/>	<input type="checkbox"/>	<input type="checkbox"/>	<input type="checkbox"/>	<input type="checkbox"/>

Parameter description:

Optimize EEE for

The switch can be set to optimize EEE for either best power saving or least traffic latency.

- **Port:**

The switch port number of the logical port.

- **ActiPHY :**

Link down power savings enabled.

ActiPHY works by lowering the power for a port when there is no link. The port is power up for short moment in order to determine if cable is inserted.

- **PerfectReach :**

Cable length power savings enabled.

PerfectReach works by determining the cable length and lowering the power for ports with short cables.

- **EEE :**

Controls whether EEE is enabled for this switch port.

For maximizing power savings, the circuit isn't started at once transmit data is ready for a port, but is instead queued until a burst of data is ready to be transmitted. This will give some traffic latency.

If desired it is possible to minimize the latency for specific frames, by mapping the frames to a specific queue (done with QOS), and then mark the queue as an urgent queue. When an urgent queue gets data to be transmitted, the circuits will be powered up at once and the latency will be reduced to the wakeup time.

- **EEE Urgent Queues :**

Queues set will activate transmission of frames as soon as data is available. Otherwise the queue will postpone transmission until a burst of frames can be transmitted.

3-3 Ports Configuration

The section describes to configure the Port detail parameters of the switch. Others you could using the Port configure to enable or disable the Port of the switch. Monitor the ports content or status in the function.

3-3.1 Ports

This page displays current port configurations. Ports can also be configured here.

Web Interface



















To configure a Current Port Configuration in the web interface:

1. Click Configuration, Ports Configuration, and Ports
2. Specify the Speed Configured, Flow Control, Maximum Frame size, Excessive Collision mode and Power Control.
3. Click Apply.

Figure 3-3.1: The Port Configuration

Ports Configuration Home > Configuration > Ports Configuration > Ports



Port	Link	Speed		Flow Control			Maximum Frame Size	Excessive Collision Mode
		Current	Configured	Current Rx	Current Tx	Configured		
*			<> <input type="checkbox"/>			<input type="checkbox"/>	9600	<> <input type="checkbox"/>
1		1Gfdx	Auto <input type="checkbox"/>			<input type="checkbox"/>	9600	Discard <input type="checkbox"/>
2		Down	Auto <input type="checkbox"/>			<input type="checkbox"/>	9600	Discard <input type="checkbox"/>
3		Down	Auto <input type="checkbox"/>			<input type="checkbox"/>	9600	Discard <input type="checkbox"/>
24		Down	Auto <input type="checkbox"/>			<input type="checkbox"/>	9600	Discard <input type="checkbox"/>
25		Down	SFP_Auto_AMS <input type="checkbox"/>			<input type="checkbox"/>	9600	Discard <input type="checkbox"/>
26		Down	SFP_Auto_AMS <input type="checkbox"/>			<input type="checkbox"/>	9600	Discard <input type="checkbox"/>

Parameter description:

- **Port :**

This is the logical port number for this row.

- **Link :**

The current link state is displayed graphically. Green indicates the link is up and red that it is down.
- **Current Link Speed :**

Provides the current link speed of the port.
- **Configured Link Speed :**

Selects any available link speed for the given switch port. Only speeds supported by the specific port is shown. Possible speeds are:

 - Disabled - Disables the switch port operation.
 - Auto - Port auto negotiating speed with the link partner and selects the highest speed that is compatible with the link partner.
 - 10Mbps HDX - Forces the cu port in 10Mbps half duplex mode.
 - 10Mbps FDX - Forces the cu port in 10Mbps full duplex mode.
 - 100Mbps HDX - Forces the cu port in 100Mbps half duplex mode.
 - 100Mbps FDX - Forces the cu port in 100Mbps full duplex mode.
 - 1Gbps FDX - Forces the port in 1Gbps full duplex
 - 2.5Gbps FDX - Forces the Serdes port in 2.5Gbps full duplex mode.
 - SFP_Auto_AMS - Automatically determines the speed of the SFP. Note: There is no standardized way to do SFP auto detect, so here it is done by reading the SFP rom. Due to the missing standardized way of doing SFP auto detect some SFPs might not be detectable. The port is set in AMS mode. Cu port is set in Auto mode.
 - 100-FX - SFP port in 100-FX speed. Cu port disabled.
 - 100-FX_AMS - Port in AMS mode. SFP port in 100-FX speed. Cu port in Auto mode.
 - 1000-X - SFP port in 1000-X speed. Cu port disabled.
 - 1000-X_AMS - Port in AMS mode. SFP port in 1000-X speed. Cu port in Auto mode. Ports in AMS mode with 1000-X speed has Cu port preferred. Ports in AMS mode with 100-FX speed has fiber port preferred.
- **Flow Control :**

When Auto Speed is selected on a port, this section indicates the flow control capability that is advertised to the link partner. When a fixed-speed setting is selected, that is what is used. The Current Rx column indicates whether pause frames on the port are obeyed, and the Current Tx column indicates whether pause frames on the port are transmitted. The Rx and Tx settings are determined by the result of the last Auto-Negotiation.

Check the configured column to use flow control. This setting is related to the setting for Configured Link Speed.
- **Maximum Frame Size :**

Enter the maximum frame size allowed for the switch port, including FCS.
- **Excessive Collision Mode :**

Configure port transmit collision behavior.

 - Discard:** Discard frame after 16 collisions (default).
 - Restart:** Restart backoff algorithm after 16 collisions.
- **Buttons**
 - Apply** – Click to save changes.

Reset- Click to undo any changes made locally and revert to previously saved values.

- **Upper right icon (Refresh)**

You can click them for refresh the Port link Status by manual

3-3.2 Ports Description

The section describes to configure the Port's alias or any descriptions for the Port Identity. It provides user to write down an alphanumeric string describing the full name and version identification for the system's hardware type, software version, and networking application

Web Interface

To configure an Port Description in the web interface:

1. Click Configuration, Port, then Port Description
2. Specify the detail Port alias or description an alphanumeric string describing the full name and version identification for the system's hardware type, software version, and networking application.
3. Click Apply.

Figure 3-3.1: The Port Configuration

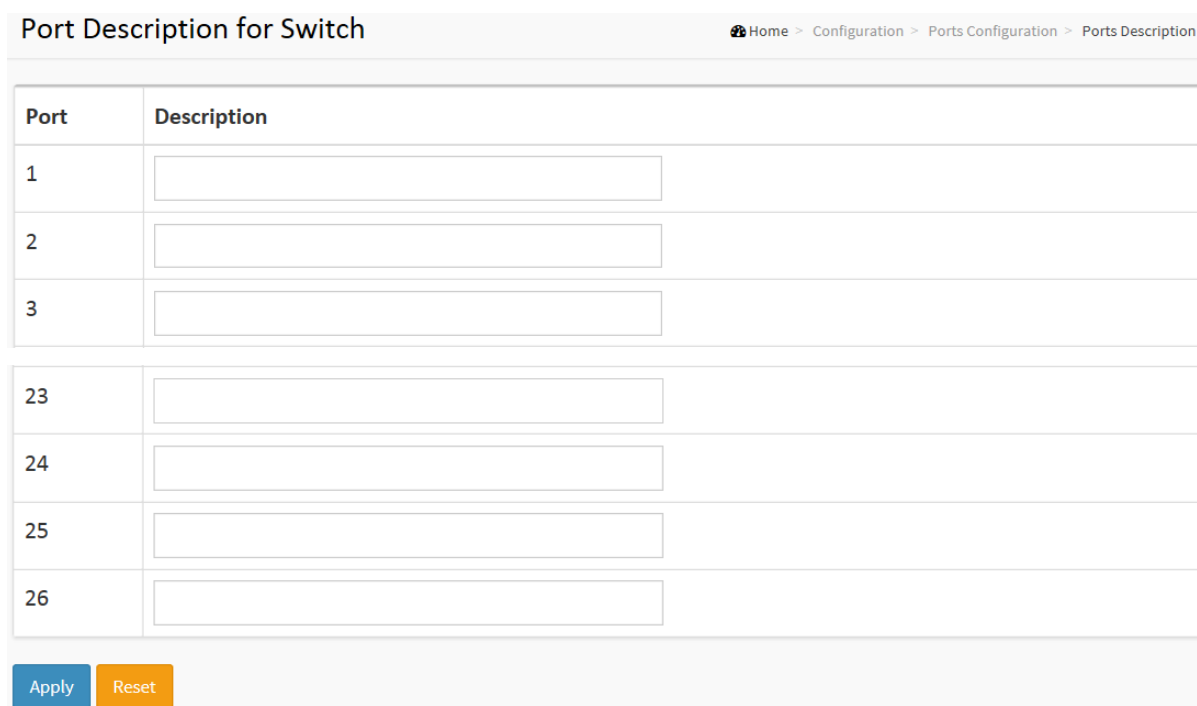

Port	Description
1	<input type="text"/>
2	<input type="text"/>
3	<input type="text"/>
23	<input type="text"/>
24	<input type="text"/>
25	<input type="text"/>
26	<input type="text"/>

Apply Reset

Parameter description:

- **Port :**
This is the logical port number for this row.
- **Description :**
Enter up to 47 characters to be descriptive name for identifies this port.
- **Buttons**
 - Apply** – Click to save changes.
 - Reset**- Click to undo any changes made locally and revert to previously saved values.

3-4 DHCP

The section describes to configure the DHCP Snooping parameters of the switch. The DHCP Snooping can prevent attackers from adding their own DHCP servers to the network.

3-4.1 Server

3-4.1.1 Mode

This page configures global mode and VLAN mode to enable/disable DHCP server per system and per VLAN.

Web Interface

To configure DHCP server mode in the web interface:

1. Click Configuration, DHCP, Server, Mode
2. Select "Enabled" in the Global Mode of DHCP Server Mode Configuration.
3. Add Vlan range.
4. Click Apply.

Figure 3-4.1.1: The DHCP server Mode

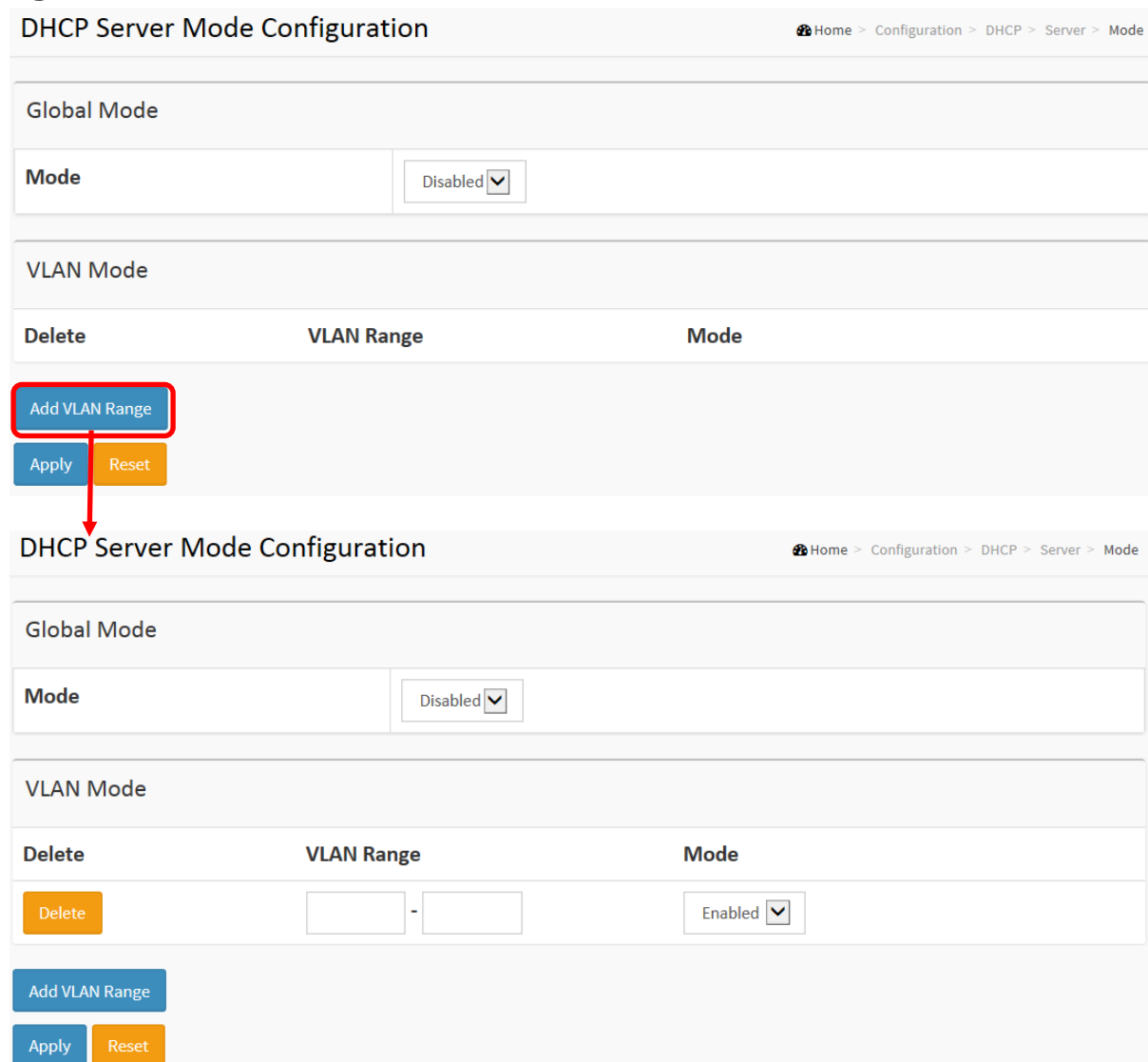

The figure shows two screenshots of the DHCP Server Mode Configuration web interface. The top screenshot shows the 'Global Mode' set to 'Disabled'. A red box highlights the 'Add VLAN Range' button, with a red arrow pointing to the bottom screenshot. In the bottom screenshot, the 'Global Mode' is now 'Enabled', and a new VLAN range has been added to the table. The 'Delete' button for this entry is highlighted in orange.

Delete	VLAN Range	Mode
Delete	<input type="text"/> - <input type="text"/>	Enabled <input type="checkbox"/>

Parameter description:

- **Mode :**

Configure the operation mode per system. Possible modes are:

Enabled: Enable DHCP server per system.

Disabled: Disable DHCP server per system.

- **VLAN Range :**

Indicate the VLAN range in which DHCP server is enabled or disabled. The first VLAN ID must be smaller than or equal to the second VLAN ID. BUT, if the VLAN range contains only 1 VLAN ID, then you can just input it into either one of the first and second VLAN ID or both.

On the other hand, if you want to disable existed VLAN range, then you can follow the steps.

1. press "ADD VLAN Range" to add a new VLAN range.
2. input the VLAN range that you want to disable.
3. choose Mode to be Disabled.
4. press Apply to apply the change.

Then, you will see the disabled VLAN range is removed from the DHCP Server mode configuration page.

- **Mode :**

Indicate the the operation mode per VLAN. Possible modes are:

Enabled: Enable DHCP server per VLAN.

Disabled: Disable DHCP server per VLAN.

- **Buttons**

Add VLAN Range - Click to add a new VLAN range.

Apply - Click to save changes.

Reset - Click to undo any changes made locally and revert to previously saved values.

3-4.1.2 Excluded IP

This page configures excluded IP addresses. DHCP server will not allocate these excluded IP addresses to DHCP client.

Web Interface

To configure DHCP server excluded IP in the web interface:

1. Click Configuration, DHCP, Server, Excluded IP
2. Click Add IP Range then you can create new IP Range on the switch.
3. Click Apply.

Figure 3-4.1.2: The DHCP server excluded IP

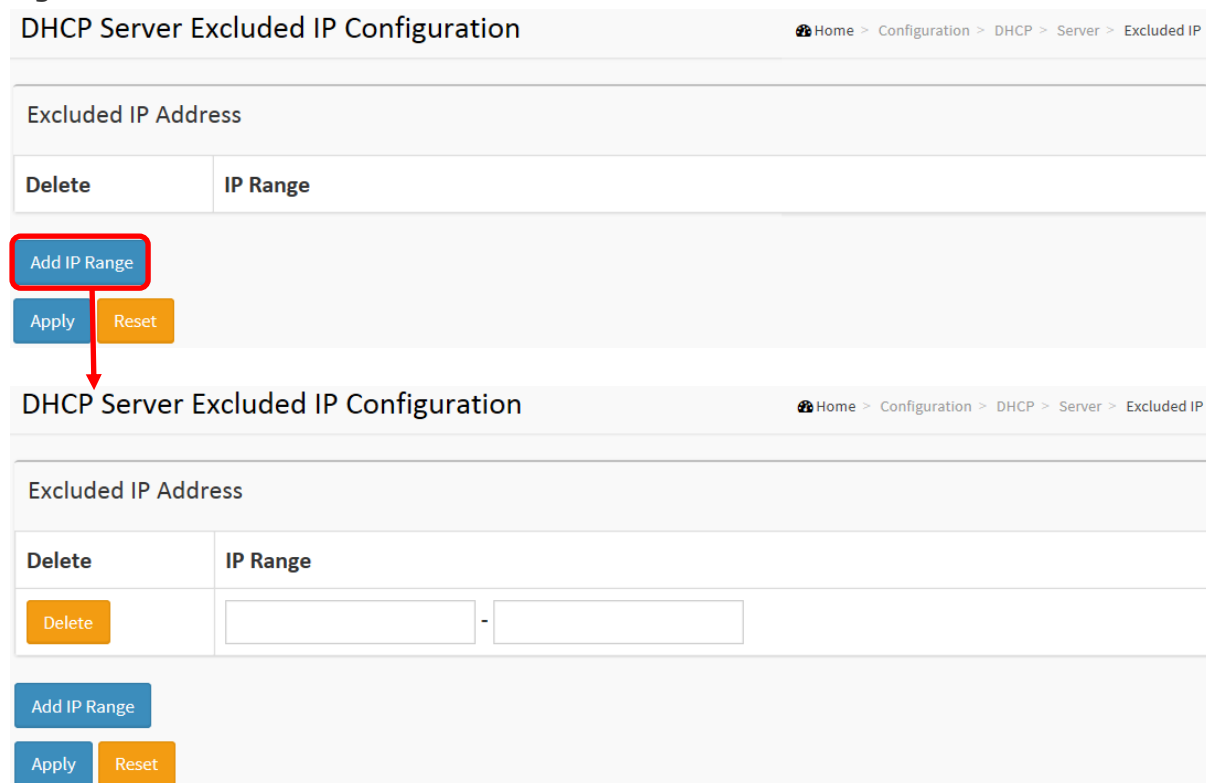

Parameter description:

- **IP Range :**

Define the IP range to be excluded IP addresses. The first excluded IP must be smaller than or equal to the second excluded IP. BUT, if the IP range contains only 1 excluded IP, then you can just input it to either one of the first and second excluded IP or both.

- **Buttons**

Add IP Range - Click to add a new excluded IP range.

Apply - Click to save changes.

Reset - Click to undo any changes made locally and revert to previously saved values.

3-4.1.3 Pool

This page manages DHCP pools. According to the DHCP pool, DHCP server will allocate IP address and deliver configuration parameters to DHCP client.

Web Interface

To configure DHCP server pool in the web interface:

1. Click Configuration, DHCP, Server, Pool
2. Click Add New Pool then you can create new Pool on the switch.
3. Click Apply.

Figure 3-4.1.1: The DHCP server pool

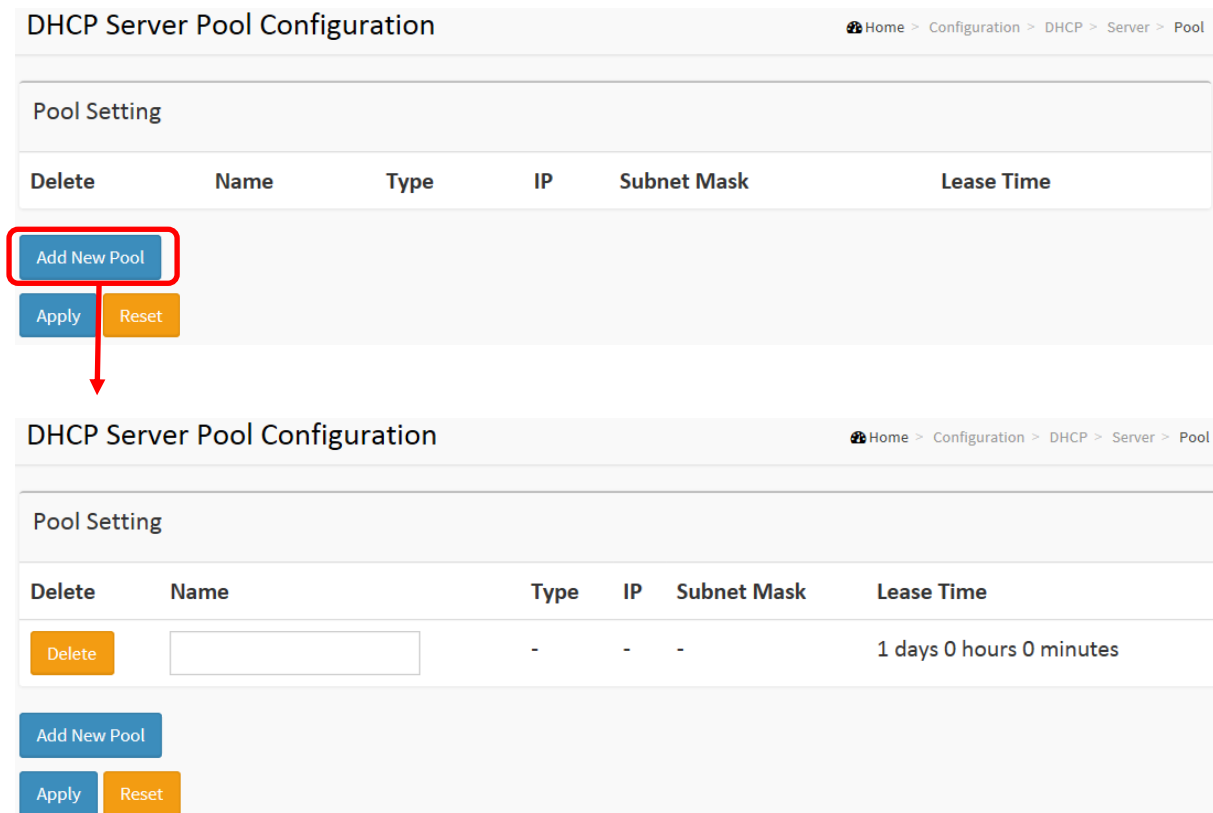

Parameter description:

Pool Setting

Add or delete pools.

Adding a pool and giving a name is to create a new pool with "default" configuration. If you want to configure all settings including type, IP subnet mask and lease time, you can click the pool name to go into the configuration page.

- **Name :**

Configure the pool name that accepts all printable characters, except white space. If you want to configure the detail settings, you can click the pool name to go into the configuration page.

- **Type :**

Display which type of the pool is.

Network: the pool defines a pool of IP addresses to service more than one DHCP client.

Host: the pool services for a specific DHCP client identified by client identifier or hardware address.

If "-" is displayed, it means not defined.

- **IP :**

Display network number of the DHCP address pool.

If "-" is displayed, it means not defined.

- **Subnet Mask :**

Display subnet mask of the DHCP address pool.

If "-" is displayed, it means not defined.

- **Lease Time :**

Display lease time of the pool.

- **Buttons**

Add New Pool - Click to add a new DHCP pool.

Apply - Click to save changes.

Reset - Click to undo any changes made locally and revert to previously saved values.

3-4.2 Snooping

DHCP Snooping is used to block intruder on the untrusted ports of the switch device when it tries to intervene by injecting a bogus DHCP reply packet to a legitimate conversation between the DHCP client and server.

The section describes to configure the DHCP Snooping parameters of the switch. The DHCP Snooping can prevent attackers from adding their own DHCP servers to the network.

Web Interface

To configure DHCP snooping in the web interface:

1. Click Configuration, DHCP, Snooping
2. Select “Enabled” in the Mode of DHCP Snooping Configuration.
3. Select “Trusted” of the specific port in the Mode of Port Mode Configuration.
4. Click Apply.

Figure 3-4.2: The DHCP Snooping Configuration

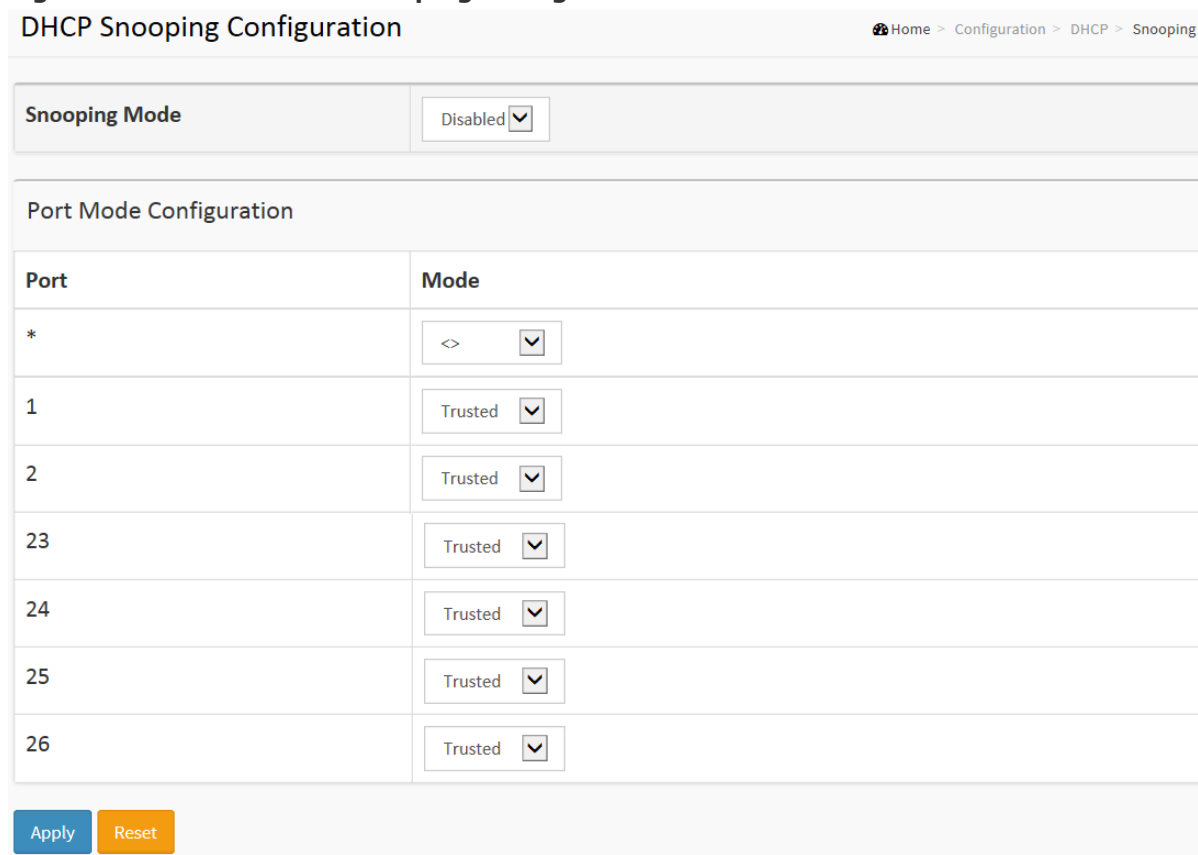

DHCP Snooping Configuration Home > Configuration > DHCP > Snooping

Snooping Mode: Disabled

Port Mode Configuration

Port	Mode
*	<>
1	Trusted
2	Trusted
23	Trusted
24	Trusted
25	Trusted
26	Trusted

Apply Reset

Parameter description:

- **Snooping Mode :**

Indicates the DHCP snooping mode operation. Possible modes are:

Enabled: Enable DHCP snooping mode operation. When DHCP snooping mode operation is enabled, the DHCP request messages will be forwarded to trusted ports and only allow reply packets from trusted ports.

Disabled: Disable DHCP snooping mode operation.

- **Port Mode Configuration**

Indicates the DHCP snooping port mode. Possible port modes are:

Trusted: Configures the port as trusted source of the DHCP messages.

Untrusted: Configures the port as untrusted source of the DHCP messages.

- **Buttons**

Apply – Click to save changes.

Reset - Click to undo any changes made locally and revert to previously saved values.

3-5 Security

This section shows you to to configure the Port Security settings of the Switch. You can use the Port Security feature to restrict input to an interface by limiting and identifying MAC addresses.

3-5.1 Switch

3-5.1.1 Users

This page provides an overview of the current users. Currently the only way to login as another user on the web server is to close and reopen the browser

Web Interface

To configure User in the web interface:

1. Click Configuration, Security, Switch, Users.
2. Click Add new user
3. Specify the User Name parameter.
4. Click Apply.

Figure 3-5.1.1: The Users configuration

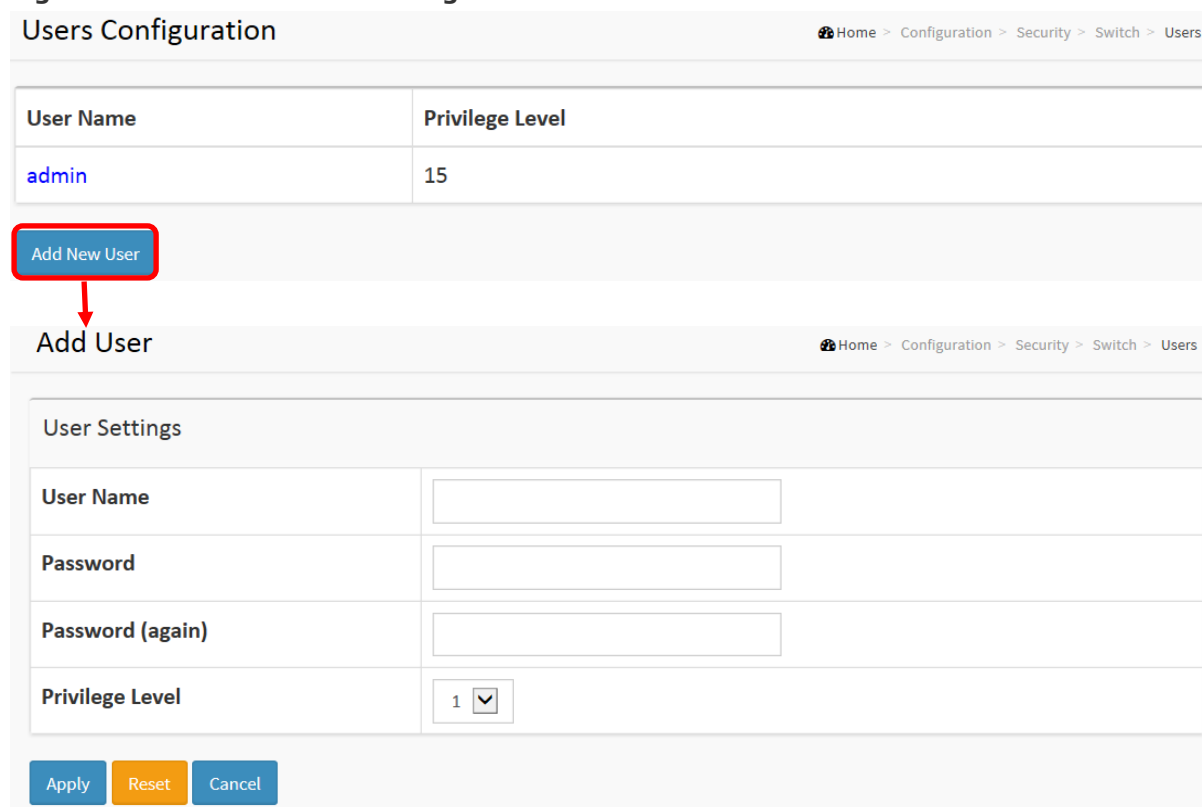

The screenshot shows two parts of the web interface. The top part is the 'Users Configuration' page, which displays a table with the following data:

User Name	Privilege Level
admin	15

Below the table is a blue button labeled 'Add New User' with a red border and a red arrow pointing down to the 'Add User' form. The 'Add User' form contains the following fields:

- User Name:** A text input field.
- Password:** A text input field.
- Password (again):** A text input field.
- Privilege Level:** A dropdown menu with '1' selected.

At the bottom of the form are three buttons: 'Apply' (blue), 'Reset' (orange), and 'Cancel' (blue).

Parameter description:

- **User Name :**

The name identifying the user. This is also a link to Add/Edit User.

- **Password**

To type the password. The allowed string length is 0 to 255, and the allowed content is the ASCII characters from 32 to 126.

- **Password (again)**

To type the password again. You must type the same password again in the field.

- **Privilege Level :**

The privilege level of the user. The allowed range is 1 to 15. If the privilege level value is 15, it can access all groups, i.e. that is granted the fully control of the device. But others value need to refer to each group privilege level. User's privilege should be same or greater than the group privilege level to have the access of that group. By default setting, most groups privilege level 5 has the read-only access and privilege level 10 has the read-write access. And the system maintenance (software upload, factory defaults and etc.) need user privilege level 15. Generally, the privilege level 15 can be used for an administrator account, privilege level 10 for a standard user account and privilege level 5 for a guest account.

- **Buttons**

Apply – Click to save changes.

Reset - Click to undo any changes made locally and revert to previously saved values.

Cancel - Click to undo any changes made locally and return to the Users.

Delete User - Delete the current user. This button is not available for new configurations (Add new user)

3-5.1.2 Privilege Level

This page provides an overview of the privilege levels. The switch provides user set Account, Aggregation, Diagnostics, EEE, GARP, GVRP, IP, IPMC Snooping LACP LLDP LLDP MED MAC Table MRP MVR MVRP Maintenance Mirroring POE Ports Private VLANs QoS SMTP SNMP Security Spanning Tree System Trap Event VCL VLANs Voice VLAN Privilege Levels from 1 to 15 .

Web Interface

To configure Privilege Level in the web interface:

1. Click SYSTEM, Account, Privilege Level.
2. Specify the Privilege parameter.
3. Click Apply.

Figure 3-5.1.2: The Privilege Level configuration

Privilege Level Configuration
Home > Configuration > Security > Switch > Privilege Levels

Group Name	Privilege Levels			
	Configuration Read-only	Configuration/Execute Read/write	Status/Statistics Read-only	Status/Statistics Read/write
ACTIVATE	5 ▼	10 ▼	5 ▼	10 ▼
Aggregation	5 ▼	10 ▼	5 ▼	10 ▼
cloud_management	5 ▼	10 ▼	5 ▼	10 ▼
Debug	15 ▼	15 ▼	15 ▼	15 ▼
VLANs	5 ▼	10 ▼	5 ▼	10 ▼
Voice_VLAN	5 ▼	10 ▼	5 ▼	10 ▼
VTUN	5 ▼	10 ▼	5 ▼	10 ▼
XXRP	5 ▼	10 ▼	5 ▼	10 ▼

Apply
Reset

Parameter description:

- **Group Name**

The name identifying the privilege group. In most cases, a privilege level group consists of a single module (e.g. LACP, RSTP or QoS), but a few of them contains more than one. The following description defines these privilege level groups in details:

System: Contact, Name, Location, Timezone, Daylight Saving Time, Log.

Security: Authentication, System Access Management, Port (contains Dot1x port, MAC based and the MAC Address Limit), ACL, HTTPS, SSH, ARP Inspection, IP source guard.

IP: Everything except 'ping'.

Port: Everything except 'VeriPHY'.

Diagnostics: 'ping' and 'VeriPHY'.

Maintenance: CLI- System Reboot, System Restore Default, System Password, Configuration Save, Configuration Load and Firmware Load. Web- Users, Privilege Levels and everything in Maintenance.

Debug: Only present in CLI.

- **Privilege Levels**

Every group has an authorization Privilege level for the following sub groups: configuration read-only, configuration/execute read-write, status/statistics read-only, status/statistics read-write (e.g. for clearing of statistics). User Privilege should be same or greater than the authorization Privilege level to have the access to that group.

- **Buttons**

Apply – Click to save changes.

Reset - Click to undo any changes made locally and revert to previously saved values.

3-5.1.3 Authentication Method

This page shows how to configure a user with authenticated when he logs into the switch via one of the management client interfaces.

Web Interface

To configure a Authentication Method Configuration in the web interface:

1. Specify the Client (ssh, web) which you want to monitor.
2. Specify the Authentication Method (none,local, radius, tacacs+)
3. Checked Fallback.
4. Click Apply.

Figure 3-4.1.3: The Authentication Method Configuration

Authentication Method Configuration

Client	Methods			
telnet	local <input type="button" value="v"/>	no <input type="button" value="v"/>	no <input type="button" value="v"/>	no <input type="button" value="v"/>
ssh	local <input type="button" value="v"/>	no <input type="button" value="v"/>	no <input type="button" value="v"/>	no <input type="button" value="v"/>
http	local <input type="button" value="v"/>	no <input type="button" value="v"/>	no <input type="button" value="v"/>	no <input type="button" value="v"/>

Parameter description:

- **Client :**

The management client for which the configuration below applies.

- **Authentication Method :**

Authentication Method can be set to one of the following values:

- none : authentication is disabled and login is not possible.
- local : use the local user database on the switch for authentication.
- radius : use a remote RADIUS server for authentication.
- tacacs+ : use a remote TACACS+ server for authentication.

Methods that involves remote servers are timed out if the remote servers are offline. In this case the next method is tried. Each method is tried from left to right and continues until a method either approves or rejects a user. If a remote server is used for primary authentication it is recommended to configure secondary authentication as 'local'. This will enable the management client to login via the local user database if none of the configured authentication servers are alive.

- **Buttons:**

Apply – Click to save changes.

Reset- Click to undo any changes made locally and revert to previously saved values.

2-5.1.4 HTTPS

This section shows you how to use HTTPS to securely access the Switch. HTTPS is a secure communication protocol that combines authentication and data encryption to provide secure encrypted communication via the browser.

Web Interface

To configure a HTTPS Configuration in the web interface:

1. Select “Enabled” in the Mode of HTTPS Configuration.
2. Select “Enabled” in the Automatic Redirect of HTTPS Configuration.
3. Click Apply.

Figure 3-5.1.5: The HTTPS Configuration

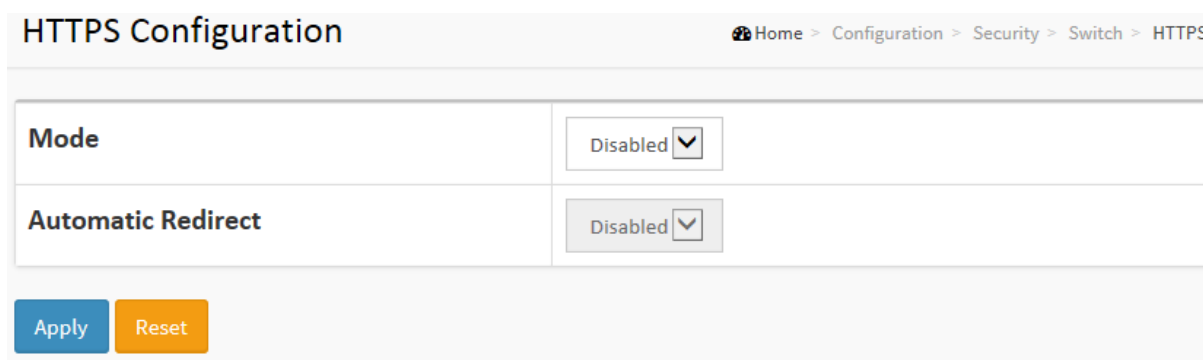

HTTPS Configuration	
Home > Configuration > Security > Switch > HTTPS	
Mode	Disabled ▾
Automatic Redirect	Disabled ▾
<input type="button" value="Apply"/> <input type="button" value="Reset"/>	

Parameter description:

- **Mode :**

Indicates the HTTPS mode operation. Possible modes are:

Enabled: Enable HTTPS mode operation.

Disabled: Disable HTTPS mode operation.

- **Automatic Redirect :**

Indicates the HTTPS redirect mode operation. Automatically redirect web browser to HTTPS when HTTPS mode is enabled. Possible modes are:

Enabled: Enable HTTPS redirect mode operation.

Disabled: Disable HTTPS redirect mode operation.

3-5.1.6 SNMP

Any Network Management System (NMS) running the Simple Network Management Protocol (SNMP) can manage the Managed devices equipped with SNMP agent, provided that the Management Information Base (MIB) is installed correctly on the managed devices. The SNMP is a protocol that is used to govern the transfer of information between SNMP manager and agent and traverses the Object Identity (OID) of the management Information Base (MIB), described in the form of SMI syntax. SNMP agent is running on the switch to response the request issued by SNMP manager.

Basically, it is passive except issuing the trap information. The switch supports a switch to turn on or off the SNMP agent. If you set the field SNMP “Enable”, SNMP agent will be started up. All supported MIB OIDs, including RMON MIB, can be accessed via SNMP manager. If the field SNMP is set “Disable”, SNMP agent will be de-activated, the related Community Name, Trap Host IP Address, Trap and all MIB counters will be ignored.

3-5.1.7.1 System

This section describes how to configure SNMP System on the switch. This function is used to configure SNMP settings, community name, trap host and public traps as well as the throttle of SNMP. A SNMP manager must pass the authentication by identifying both community names, then it can access the MIB information of the target device. So, both parties must have the same community name. Once completing the setting, click <Apply> button, the setting takes effect.

Web Interface

To display the configure SNMP System in the web interface:

1. Click SNMP, System.
2. Evoke SNMP State to enable or disable the SNMP function.
3. Specify the Engine ID
4. Click Apply.

Figure 3-5.1.6.1: The SNMP System Configuration

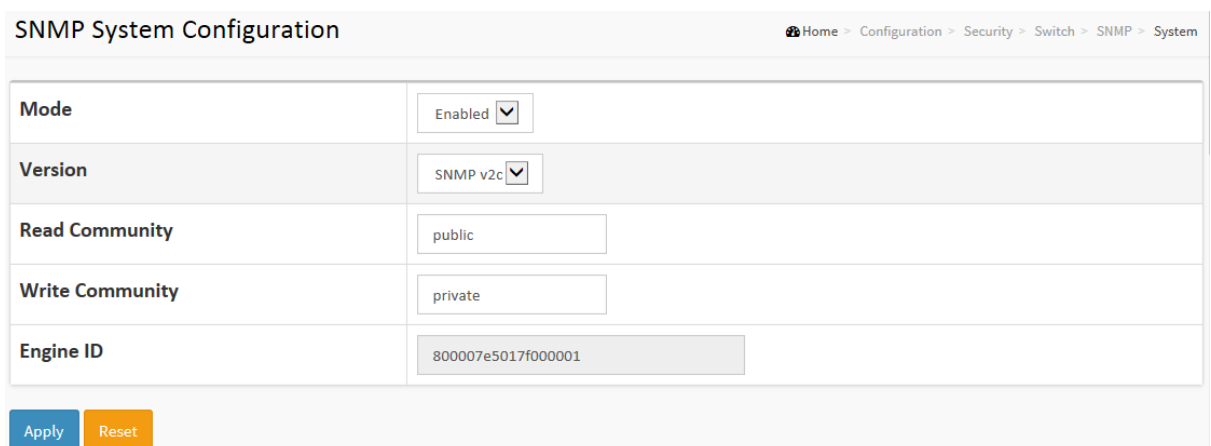

SNMP System Configuration	
Mode	Enabled
Version	SNMP v2c
Read Community	public
Write Community	private
Engine ID	800007e5017f000001

Apply Reset

Parameter description:

- **Mode :**
Indicates the SNMP mode operation. Possible modes are:
Enabled: Enable SNMP mode operation.
Disabled: Disable SNMP mode operation.
- **Version**

Indicates the SNMP supported version. Possible versions are:

SNMP v1: Set SNMP supported version 1.

SNMP v2c: Set SNMP supported version 2c.

SNMP v3: Set SNMP supported version 3.

- **Read Community**

Indicates the community read access string to permit access to SNMP agent. The allowed string length is 0 to 255, and the allowed content is the ASCII characters from 33 to 126.

The field is applicable only when SNMP version is SNMPv1 or SNMPv2c. If SNMP version is SNMPv3, the community string will be associated with SNMPv3 communities table. It provides more flexibility to configure security name than a SNMPv1 or SNMPv2c community string. In addition to community string, a particular range of source addresses can be used to restrict source subnet.

- **Write Community**

Indicates the community write access string to permit access to SNMP agent. The allowed string length is 0 to 255, and the allowed content is the ASCII characters from 33 to 126.

The field is applicable only when SNMP version is SNMPv1 or SNMPv2c. If SNMP version is SNMPv3, the community string will be associated with SNMPv3 communities table. It provides more flexibility to configure security name than a SNMPv1 or SNMPv2c community string. In addition to community string, a particular range of source addresses can be used to restrict source subnet.

- **Engine ID**

Indicates the SNMPv3 engine ID. The string must contain an even number (in hexadecimal format) with number of digits between 10 and 64, but all-zeros and all-'F's are not allowed. Change of the Engine ID will clear all original local users.

3-5.1.6.2 Trap

Configure SNMP trap on this page.

Global Settings

Configure SNMP trap on this page.

Web Interface

To display the configure SNMP Trap Configuration in the web interface:

1. Click Configuration, Switch, SNMP, Trap.
2. Click Add New Entry then you can create new SNMP Trap on the switch.
3. Click Apply

Figure 3-5.1.6.2: The SNMP Trap Configuration

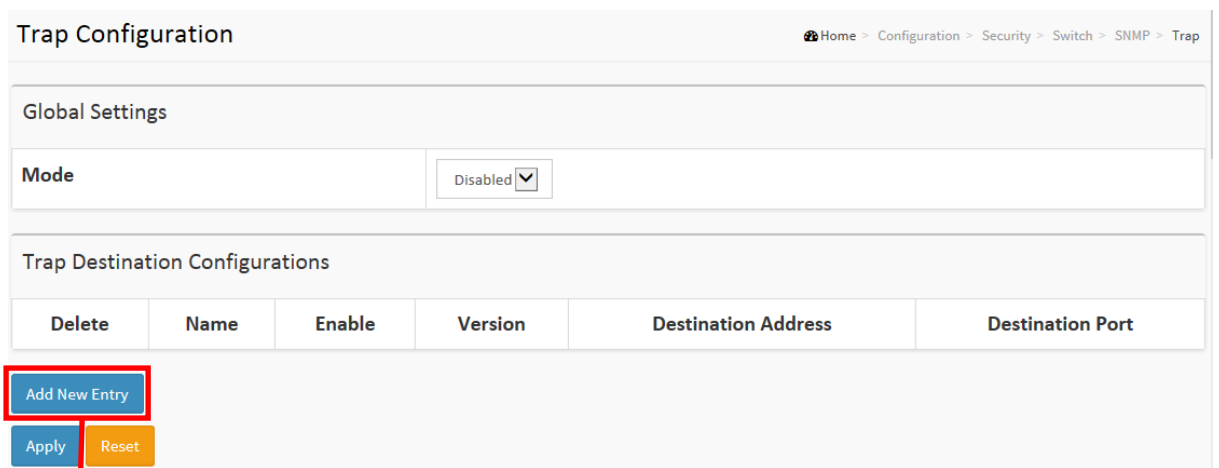

Trap Configuration Home > Configuration > Security > Switch > SNMP > Trap

Global Settings

Mode: Disabled

Trap Destination Configurations

Delete	Name	Enable	Version	Destination Address	Destination Port
Add New Entry Apply Reset					

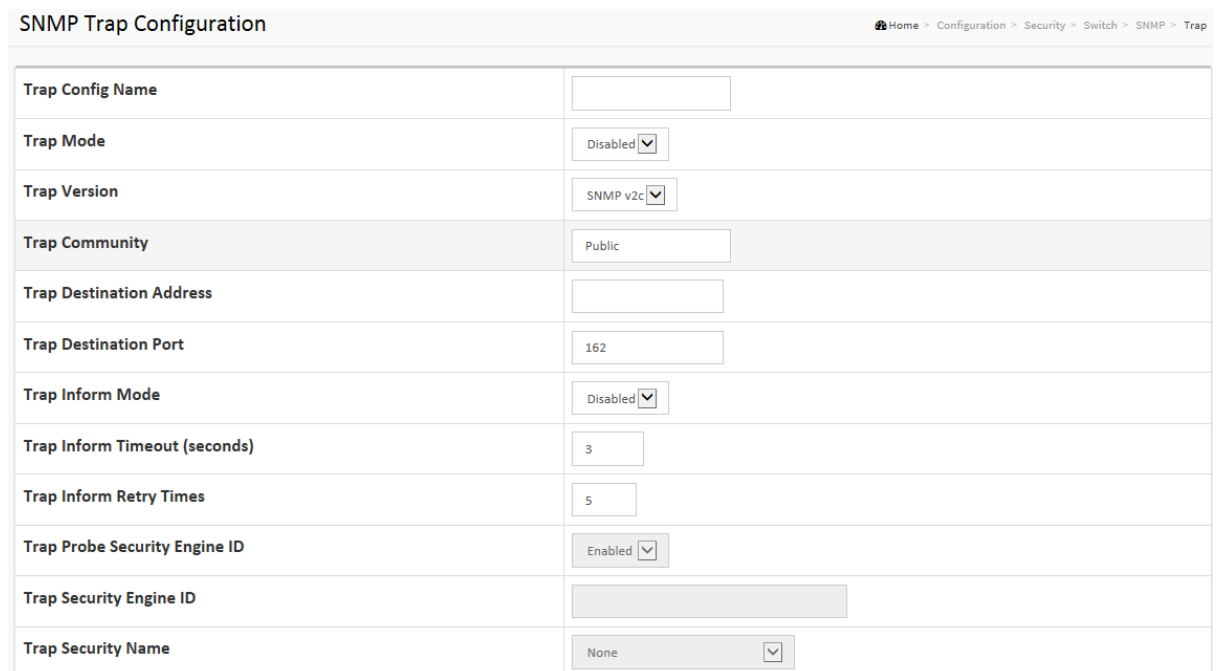

SNMP Trap Configuration Home > Configuration > Security > Switch > SNMP > Trap

Trap Config Name	<input type="text"/>
Trap Mode	Disabled
Trap Version	SNMP v2c
Trap Community	Public
Trap Destination Address	<input type="text"/>
Trap Destination Port	162
Trap Inform Mode	Disabled
Trap Inform Timeout (seconds)	3
Trap Inform Retry Times	5
Trap Probe Security Engine ID	Enabled
Trap Security Engine ID	<input type="text"/>
Trap Security Name	None

SNMP Trap Event			
System	<input type="checkbox"/> *	<input type="checkbox"/> Warm Start	<input type="checkbox"/> Cold Start
Interface	<input type="checkbox"/> *	Link up <input checked="" type="radio"/> none <input type="radio"/> specific <input type="radio"/> all switches Link down <input checked="" type="radio"/> none <input type="radio"/> specific <input type="radio"/> all switches LLDP <input checked="" type="radio"/> none <input type="radio"/> specific <input type="radio"/> all switches	
AAA	<input type="checkbox"/> *	<input type="checkbox"/> Authentication Fail	
Switch	<input type="checkbox"/> *	<input type="checkbox"/> STP	<input type="checkbox"/> RMON

- **Trap Mode**

Indicates the trap mode operation. Possible modes are:

Enabled: Enable SNMP trap mode operation.

Disabled: Disable SNMP trap mode operation.

- **Trap Destination Configurations**

Configure trap destinations on this page.

- **Name**

Indicates the trap Configuration's name. Indicates the trap destination's name.

- **Enable**

Indicates the trap destination mode operation. Possible modes are:

Enabled: Enable SNMP trap mode operation.

Disabled: Disable SNMP trap mode operation.

- **Version**

Indicates the SNMP trap supported version. Possible versions are:

SNMPv1: Set SNMP trap supported version 1.

SNMPv2c: Set SNMP trap supported version 2c.

SNMPv3: Set SNMP trap supported version 3.

- **Trap Community**

Indicates the community access string when sending SNMP trap packet. The allowed string length is 0 to 255, and the allowed content is ASCII characters from 33 to 126.

- **Destination Address**

Indicates the SNMP trap destination address. It allow a valid IP address in dotted decimal notation ('x.y.z.w').

And it also allow a valid hostname. A valid hostname is a string drawn from the alphabet (A-Za-z), digits (0-9), dot (.), dash (-). Spaces are not allowed, the first character must be an alpha character, and the first and last characters must not be a dot or a dash.

Indicates the SNMP trap destination IPv6 address. IPv6 address is in 128-bit records represented as eight fields of up to four hexadecimal digits with a colon separating each field (:). For example, 'fe80::215:c5ff:fe03:4dc7'. The symbol '::' is a special syntax that can be used as a shorthand way of representing multiple 16-bit groups of contiguous zeros; but it can appear only once. It can also represent a legally valid IPv4 address. For example, '::192.1.2.34'.

- **Destination port**

Indicates the SNMP trap destination port. SNMP Agent will send SNMP message via this port, the port range is 1~65535.

- **Trap Inform Mode**

Indicates the SNMP trap inform mode operation. Possible modes are:

Enabled: Enable SNMP trap inform mode operation.

Disabled: Disable SNMP trap inform mode operation.

- **Trap Inform Timeout (seconds)**

Indicates the SNMP trap inform timeout. The allowed range is 0 to 2147.

- **Trap Inform Retry Times**

Indicates the SNMP trap inform retry times. The allowed range is 0 to 255.

- **Trap Probe Security Engine ID**

Indicates the SNMP trap probe security engine ID mode of operation. Possible values are:

Enabled: Enable SNMP trap probe security engine ID mode of operation.

Disabled: Disable SNMP trap probe security engine ID mode of operation.

- **Trap Security Engine ID**

Indicates the SNMP trap security engine ID. SNMPv3 sends traps and informs using USM for authentication and privacy. A unique engine ID for these traps and informs is needed. When "Trap Probe Security Engine ID" is enabled, the ID will be probed automatically. Otherwise, the ID specified in this field is used. The string must contain an even number (in hexadecimal format) with number of digits between 10 and 64, but all-zeros and all-'F's are not allowed.

- **Trap Security Name**

Indicates the SNMP trap security name. SNMPv3 traps and informs using USM for authentication and privacy. A unique security name is needed when traps and informs are enabled.

Configure SNMP trap on this page.

- **System**

Enable/disable that the Interface group's traps. Possible traps are:

Warm Start: Enable/disable Warm Start trap.

Cold Start: Enable/disable Cold Start trap.

- **Interface**

Indicates that the Interface group's traps. Possible traps are: Indicates that the SNMP entity is permitted to generate authentication failure traps. Possible modes are:

Link Up: Enable/disable Link up trap.

Link Down: Enable/disable Link down trap.

LLDP: Enable/disable LLDP trap.

- **AAA**

Indicates that the AAA group's traps. Possible traps are:

Authentication Fail : Enable/disable SNMP trap authentication failure trap.

- **Switch**

Indicates that the Switch group's traps. Possible traps are:

STP: Enable/disable STP trap.

RMON: Enable/disable RMON trap.

- **Private**

Indicates the rule for private traps to be sent.

none: no private traps will be sent.

Critical: only critical level traps will be sent.

Warning: warning and critical level traps will be sent.

Info: all levels of traps (info, warning and critical) will be sent.

3-5.1.6.3 Communities

The function is used to configure SNMPv3 communities. The Community and UserName is unique. To create a new community account, please check <Add new community> button, and enter the account information then check <Save>. Max Group Number: 4.

Web Interface

To display the configure SNMP Communities in the web interface:

1. Click SNMP, Communities.
2. Click Add new community.
3. Specify the SNMP communities parameters.
4. Click Apply.
5. If you want to modify or clear the setting then click Reset.

Figure 3-4.1.6.3: The SNMPv1/v2 Communities Security Configuration

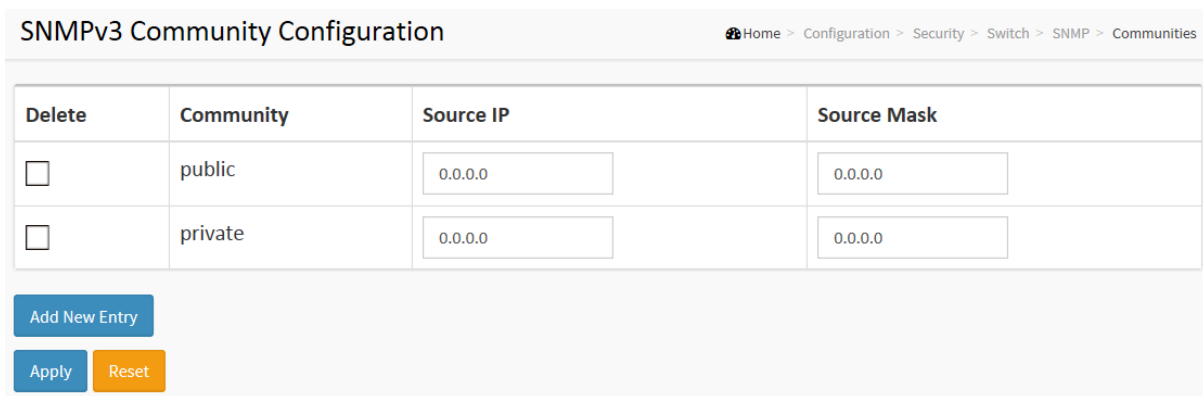

Delete	Community	Source IP	Source Mask
<input type="checkbox"/>	public	0.0.0.0	0.0.0.0
<input type="checkbox"/>	private	0.0.0.0	0.0.0.0

Parameter description:

- **Delete**
Check to delete the entry. It will be deleted during the next save.
- **Community**
Indicates the community access string to permit access to SNMPv3 agent. The allowed string length is 1 to 32, and the allowed content is ASCII characters from 33 to 126. The community string will be treated as security name and map a SNMPv1 or SNMPv2c community string.
- **Source IP**
Indicates the SNMP access source address. A particular range of source addresses can be used to restrict source subnet when combined with source mask.
- **Source Mask**
Indicates the SNMP access source address mask

3-5.1.6.4 Users

The function is used to configure SNMPv3 user. The Entry index key is UserName. To create a new UserName account, please check <Add new user> button, and enter the user information then check <Save>. Max Group Number : 10.

Web Interface

To display the configure SNMP Users in the web interface:

1. Click SNMP, Users.
2. Specify the Privilege parameter.
3. Click Apply.

Figure 3-5.1.6.4: The SNMP Users Configuration

SNMPv3 User Configuration Home > Configuration > Security > Switch > SNMP > Users

Delete	Engine ID	User Name	Security Level	Authentication Protocol	Authentication Password	Privacy Protocol	Privacy Password
<input type="checkbox"/>	800007e5017f000001	default_user	NoAuth, NoPriv	None	None	None	None

SNMPv3 User Configuration Home > Configuration > Security > Switch > SNMP > Users

Delete	Engine ID	User Name	Security Level	Authentication Protocol	Authentication Password	Privacy Protocol	Privacy Password
<input type="checkbox"/>	800007e5017f000001	default_user	NoAuth, NoPriv	None	None	None	None
<input type="button" value="Delete"/>	<input type="text"/>	<input type="text"/>	Auth, Priv <input type="button" value="v"/>	MD5 <input type="button" value="v"/>	<input type="text"/>	DES <input type="button" value="v"/>	<input type="text"/>

Parameter description:

- **Delete**

Check to delete the entry. It will be deleted during the next save.

- **Engine ID**

An octet string identifying the engine ID that this entry should belong to. The string must contain an even number (in hexadecimal format) with number of digits between 10 and 64, but all-zeros and all-'F's are not allowed. The SNMPv3 architecture uses the User-based Security Model (USM) for message security and the View-based Access Control Model (VACM) for access control. For the USM entry, the usmUserEngineID and usmUserName are the entry's keys. In a simple agent, usmUserEngineID is always that agent's own snmpEngineID value. The value can also take the value of the snmpEngineID of a remote SNMP engine with which this user can communicate. In other words, if user engine ID equal system engine ID then it is local user; otherwise it's remote user.

- **User Name**

A string identifying the user name that this entry should belong to. The allowed string length is 1 to 32, and the allowed content is ASCII characters from 33 to

126.

- **Security Level**

Indicates the security model that this entry should belong to. Possible security models are:

NoAuth, NoPriv: No authentication and no privacy.

Auth, NoPriv: Authentication and no privacy.

Auth, Priv: Authentication and privacy.

The value of security level cannot be modified if entry already exists. That means it must first be ensured that the value is set correctly.

- **Authentication Protocol**

Indicates the authentication protocol that this entry should belong to. Possible authentication protocols are:

None: No authentication protocol.

MD5: An optional flag to indicate that this user uses MD5 authentication protocol.

SHA: An optional flag to indicate that this user uses SHA authentication protocol.

The value of security level cannot be modified if entry already exists. That means must first ensure that the value is set correctly.

- **Authentication Password**

A string identifying the authentication password phrase. For MD5 authentication protocol, the allowed string length is 8 to 32. For SHA authentication protocol, the allowed string length is 8 to 40. The allowed content is ASCII characters from 33 to 126.

- **Privacy Protocol**

Indicates the privacy protocol that this entry should belong to. Possible privacy protocols are:

None: No privacy protocol.

DES: An optional flag to indicate that this user uses DES authentication protocol.

- **Privacy Password**

A string identifying the privacy password phrase. The allowed string length is 8 to 32, and the allowed content is ASCII characters from 33 to 126.

3-5.1.6.5 Group

The function is used to configure SNMPv3 group. The Entry index key are Security Model and Security Name. To create a new group account, please check <Add new group> button, and enter the group information then check <Save>. Max Group Number: v1: 2, v2: 2, v3:10.

Web Interface

To display the configure SNMP Groups in the web interface:

1. Click SNMP, Groups.
2. Specify the Privilege parameter.
3. Click Apply.

Figure 3-5.1.7.5: The SNMP Groups Configuration

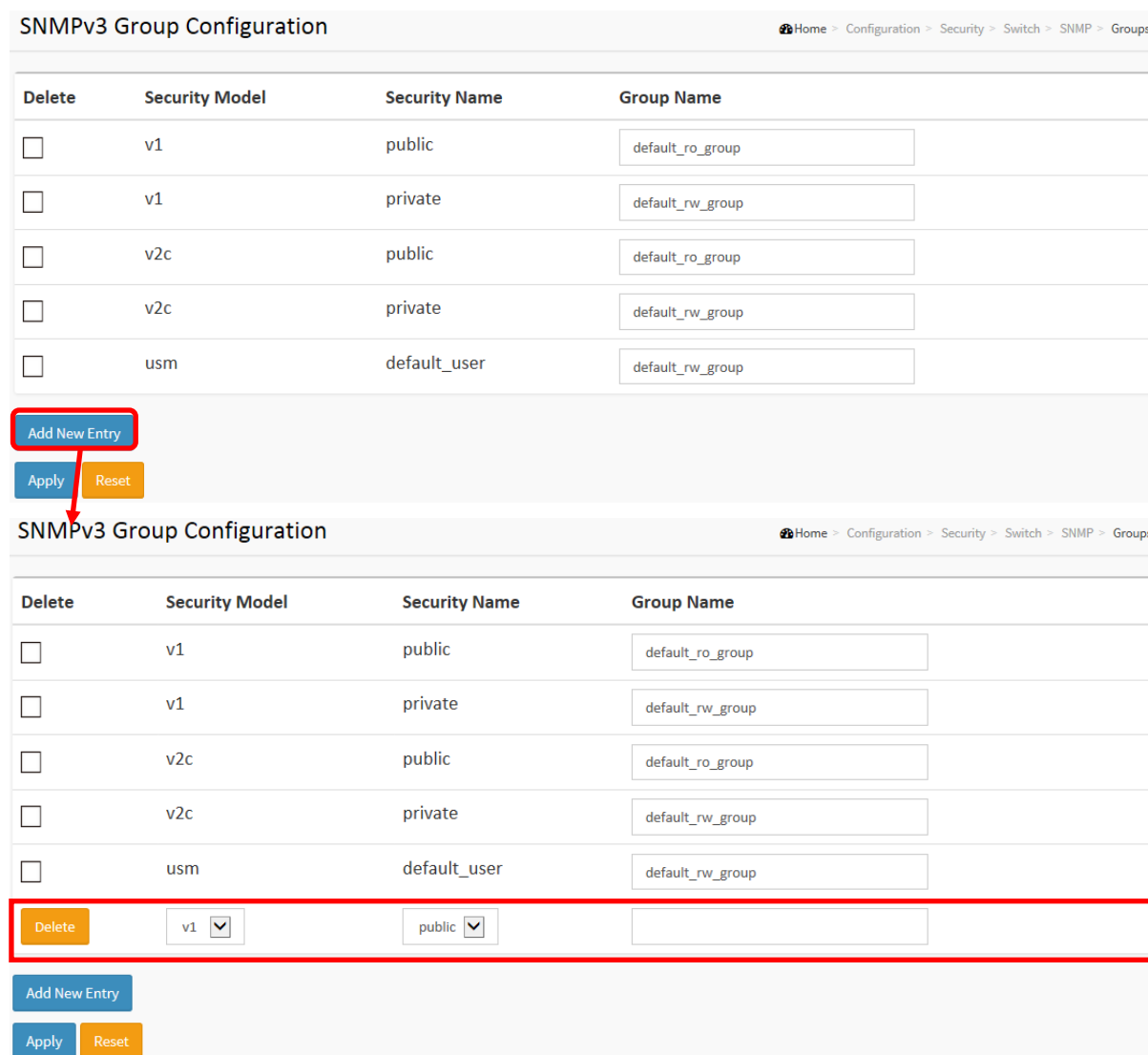

The screenshot shows the 'SNMPv3 Group Configuration' web interface. It features a table with columns for 'Delete', 'Security Model', 'Security Name', and 'Group Name'. The table contains five entries with security models v1, v1, v2c, v2c, and usm. Below the table, there are buttons for 'Add New Entry', 'Apply', and 'Reset'. A red box highlights the 'Add New Entry' button in the first screenshot. In the second screenshot, a red box highlights the 'Delete' button and the first row of the table, which has dropdown menus for 'v1' and 'public'.

Delete	Security Model	Security Name	Group Name
<input type="checkbox"/>	v1	public	default_ro_group
<input type="checkbox"/>	v1	private	default_rw_group
<input type="checkbox"/>	v2c	public	default_ro_group
<input type="checkbox"/>	v2c	private	default_rw_group
<input type="checkbox"/>	usm	default_user	default_rw_group

Parameter description:

- **Delete**

Check to delete the entry. It will be deleted during the next save.

- **Security Model**

Indicates the security model that this entry should belong to. Possible security models are:

v1: Reserved for SNMPv1.

v2c: Reserved for SNMPv2c.

usm: User-based Security Model (USM).

- **Security Name**

A string identifying the security name that this entry should belong to. The allowed string length is 1 to 32, and the allowed content is ASCII characters from 33 to 126.

- **Group Name**

A string identifying the group name that this entry should belong to. The allowed string length is 1 to 32, and the allowed content is ASCII characters from 33 to 126.

3-5.1.6.6 Views

The function is used to configure SNMPv3 view. The Entry index keys are OID Subtree and View Name. To create a new view account, please check <Add new view> button, and enter the view information then check <Save>. Max Group Number: 28.

Configure SNMPv3 view table on this page. The entry index keys are View Name and OID Subtree.

Web Interface

To display the configure SNMP views in the web interface:

1. Click SNMP, Views.
2. Click Add new View.
3. Specify the SNMP View parameters.
4. Click Apply.
5. If you want to modify or clear the setting then click Reset.

Figure 3-5.1.6.6: The SNMP Views Configuration

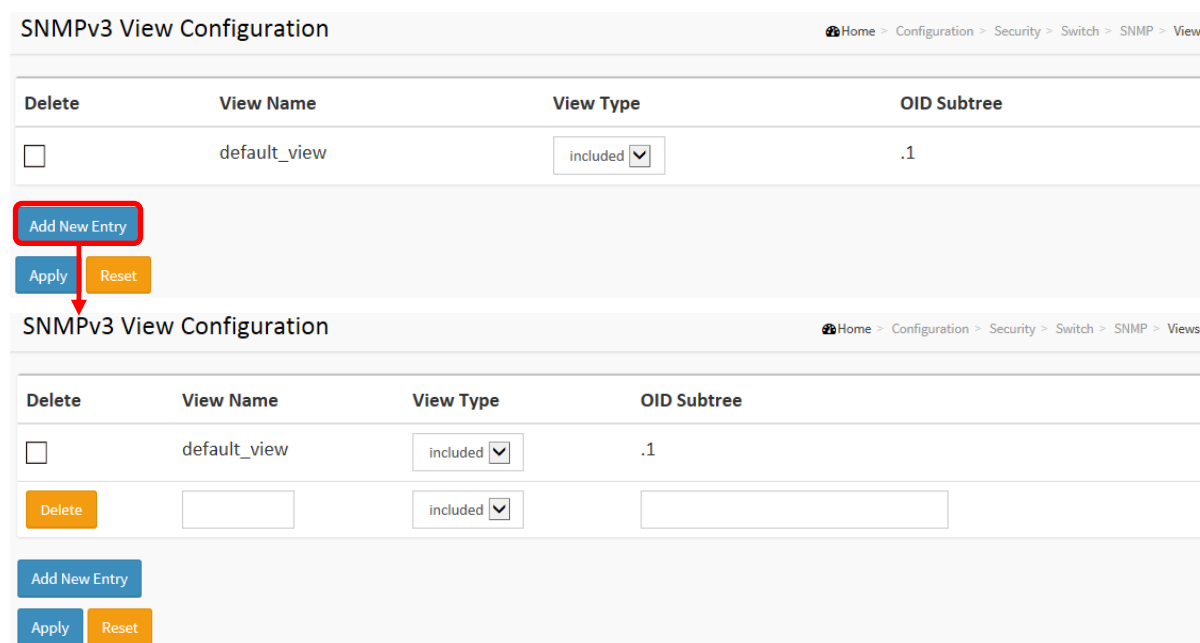

Parameter description:

- **Delete**

Check to delete the entry. It will be deleted during the next save.

- **View Name**

A string identifying the view name that this entry should belong to. The allowed string length is 1 to 32, and the allowed content is ASCII characters from 33 to 126.

- **View Type**

Indicates the view type that this entry should belong to. Possible view types are:

included: An optional flag to indicate that this view subtree should be included.

excluded: An optional flag to indicate that this view subtree should be excluded.

In general, if a view entry's view type is 'excluded', there should be another view entry existing with view type as 'included' and its OID subtree should overstep

the 'excluded' view entry.

- **OID Subtree**

The OID defining the root of the subtree to add to the named view. The allowed OID length is 1 to 128. The allowed string content is digital number or asterisk(*).

2-5.1.6.7 Access

The function is used to configure SNMPv3 accesses. The Entry index key are Group Name, Security Model and Security level. To create a new access account, please check <Add new access> button, and enter the access information then check <Save>. Max Group Number : 14

Web Interface

To display the configure SNMP Access in the web interface:

1. Click SNMP, Accesses.
2. Click Add new Access.
3. Specify the SNMP Access parameters.
4. Click Apply.
5. If you want to modify or clear the setting then click Reset.

Figure 3-5.1.6.7: The SNMP Accesses Configuration

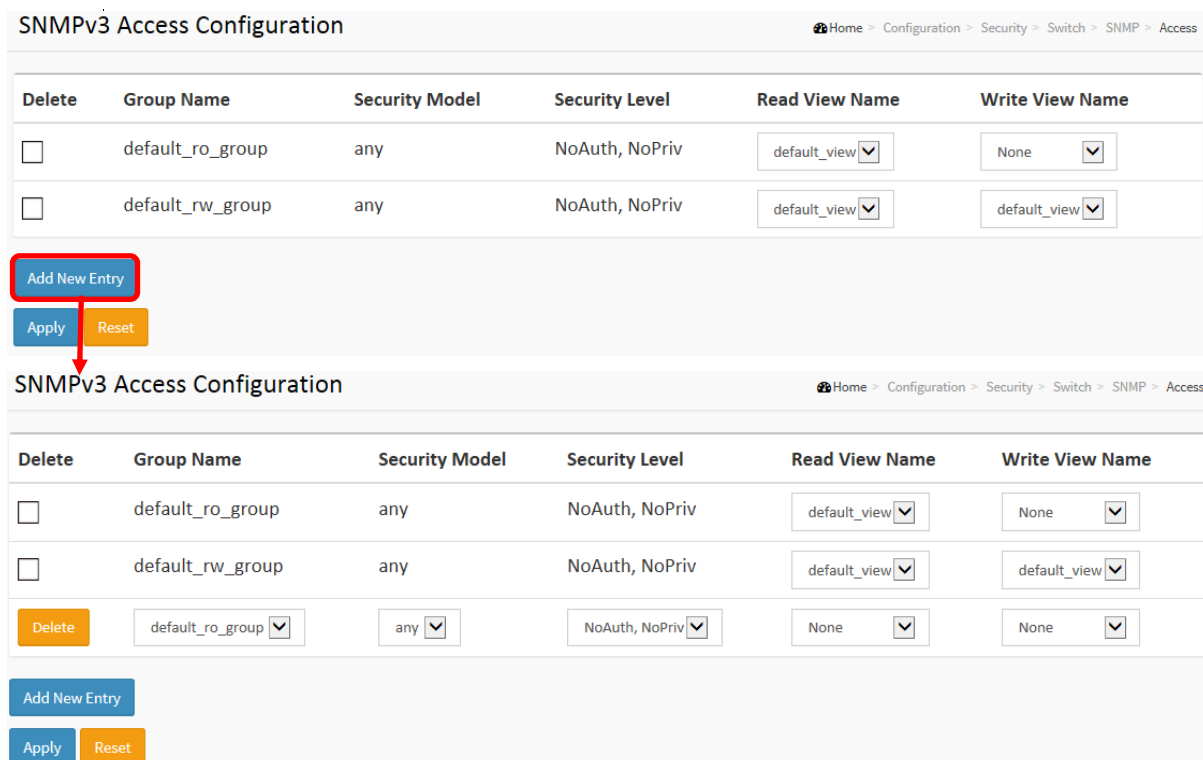

The screenshot shows the 'SNMPv3 Access Configuration' web interface. The top part displays a table with two entries: 'default_ro_group' and 'default_rw_group'. Below the table are buttons for 'Add New Entry', 'Apply', and 'Reset'. A red box highlights the 'Add New Entry' button, and a red arrow points to the second screenshot. The second screenshot shows the configuration form for a new entry, with a 'Delete' button and dropdown menus for 'Group Name', 'Security Model', 'Security Level', 'Read View Name', and 'Write View Name'.

Delete	Group Name	Security Model	Security Level	Read View Name	Write View Name
<input type="checkbox"/>	default_ro_group	any	NoAuth, NoPriv	default_view	None
<input type="checkbox"/>	default_rw_group	any	NoAuth, NoPriv	default_view	default_view

Delete	Group Name	Security Model	Security Level	Read View Name	Write View Name
<input type="checkbox"/>	default_ro_group	any	NoAuth, NoPriv	default_view	None
<input type="checkbox"/>	default_rw_group	any	NoAuth, NoPriv	default_view	default_view
<input type="button" value="Delete"/>	default_ro_group	any	NoAuth, NoPriv	None	None

Parameter description:

- **Delete**

Check to delete the entry. It will be deleted during the next save.

- **Group Name**

A string identifying the group name that this entry should belong to. The allowed string length is 1 to 32, and the allowed content is ASCII characters from 33 to 126.

- **Security Model**

Indicates the security model that this entry should belong to. Possible security models are:

any: Any security model accepted(v1|v2c|usm).

v1: Reserved for SNMPv1.

v2c: Reserved for SNMPv2c.

usm: User-based Security Model (USM).

- **Security Level**

Indicates the security model that this entry should belong to. Possible security models are:

NoAuth, NoPriv: No authentication and no privacy.

Auth, NoPriv: Authentication and no privacy.

Auth, Priv: Authentication and privacy.

- **Read View Name**

The name of the MIB view defining the MIB objects for which this request may request the current values. The allowed string length is 1 to 32, and the allowed content is ASCII characters from 33 to 126.

- **Write View Name**

The name of the MIB view defining the MIB objects for which this request may potentially set new values. The allowed string length is 1 to 32, and the allowed content is ASCII characters from 33 to 126.

3-5.1.6.8 Trap Event Severity

This page displays current trap event severity configurations. Trap event severity can also be configured here.

Web Interface

To display the configure Trap Event Severity in the web interface:

1. Click SNMP, Trap Event Severity.
2. Scroll to select the Group name and Severity Level
3. Click the Apply to save the setting
4. If you want to cancel the setting then you need to click the Reset button. It will revert to previously saved values

Figure 3-5.1.6.8: The Trap Event Severity Configuration

Trap Event Severity Configuration Home > Configuration > Security > Switch > SNMP > Trap Event Severity

Group Name	Severity Level
ACL	Info ▼
ACL Log	Info ▼
Access Mgmt	Info ▼
Auth Failed	Warning ▼
Cold Start	Warning ▼
Poe Auto Check	Warning ▼
Port Security	Info ▼
VLAN	Info ▼
Warm Start	Warning ▼

Parameter description:

- **Group Name :**
The name identifying the severity group.
- **Severity Level :**
Every group has an severity level. The following level types are supported:
 - <0> Information: Information messages.
 - <1> Warning: Warning conditions.
 - <2> Error: Error conditions.

3-5.1.7 RMON

An RMON implementation typically operates in a client/server model. Monitoring devices contain RMON software agents that collect information and analyze packets. These probes act as servers and the Network Management applications that communicate with them act as clients.

3-5.1.7.1 Statistics

Configure RMON Statistics table on this page. The entry index key is **ID**.

Web Interface

To display the configure RMON configuration in the web interface:

1. Click RMON, Statistics.
2. Click Add New Entry.
3. Specify the ID parameters.
4. Click Apply.

Figure 3-5.1.7.1: The RMON Statics Configuration

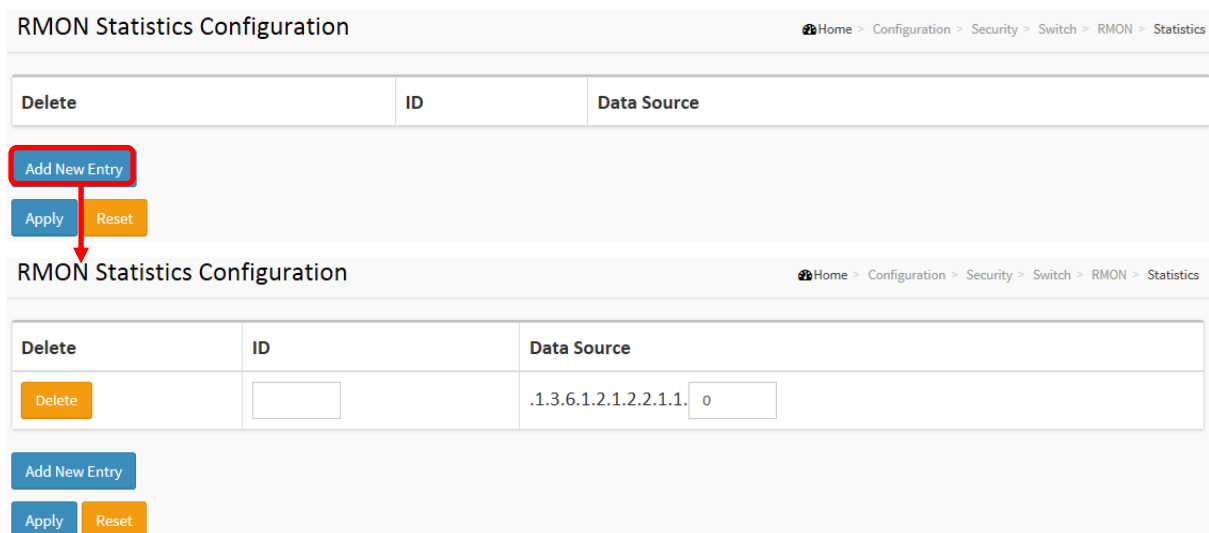

The screenshot shows the 'RMON Statistics Configuration' page in two states. In the top state, the 'Add New Entry' button is highlighted with a red box and a red arrow points to the 'Add New Entry' button in the bottom state. The bottom state shows a table with one entry:

Delete	ID	Data Source
<input type="checkbox"/>	<input type="text"/>	.1.3.6.1.2.1.2.2.1.1. <input type="text" value="0"/>

Parameter description:

These parameters are displayed on the RMON Statistics Configuration page:

- **Delete**
Check to delete the entry. It will be deleted during the next save.
- **ID**
Indicates the index of the entry. The range is from 1 to 65535.
- **Data Source**
Indicates the port ID which wants to be monitored. If in stacking switch, the value must add 1000*(switch ID-1), for example, if the port is switch 3 port 5, the value is 2005
- **Interval**
Indicates the interval in seconds for sampling the history statistics data. The range is from 1 to 3600, default value is 1800 seconds.
- **Buckets**

Indicates the maximum data entries associated this History control entry stored in RMON. The range is from 1 to 3600, default value is 50.

- **Buckets Granted**

The number of data shall be saved in the RMON.

3-5.1.7.2 History

Configure RMON History table on this page. The entry index key is **ID**.

Web Interface

To display the configure RMON History in the web interface:

1. Click RMON, History.
2. Click Add New Entry.
3. Specify the ID parameters.
4. Click Apply.

Figure 3-5.1.7.2: The RMON History Configuration

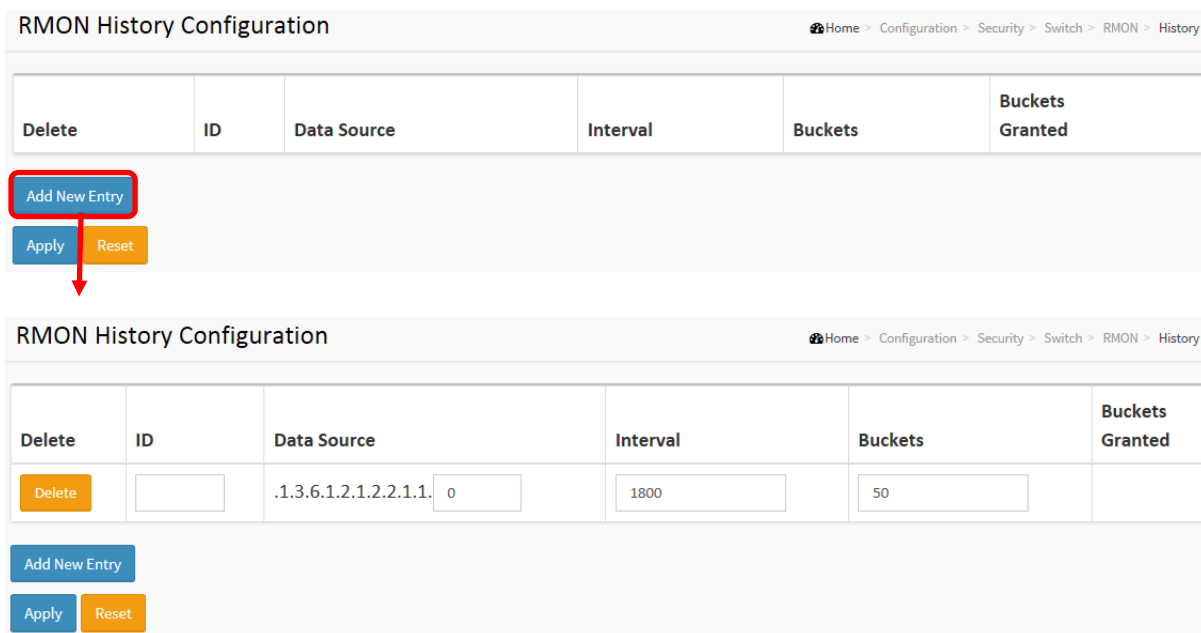

The figure shows two screenshots of the RMON History Configuration web interface. The top screenshot shows the 'Add New Entry' button highlighted with a red box and a red arrow pointing to the 'Apply' button. The bottom screenshot shows the configuration form with fields for ID, Data Source, Interval, Buckets, and Buckets Granted.

Delete	ID	Data Source	Interval	Buckets	Buckets Granted
<input type="checkbox"/>	<input type="text"/>	<input type="text"/>	<input type="text"/>	<input type="text"/>	<input type="text"/>

Buttons: Add New Entry, Apply, Reset

Parameter description:

These parameters are displayed on the RMON History Configuration page:

- **Delete**
Check to delete the entry. It will be deleted during the next save.
- **ID**
Indicates the index of the entry. The range is from 1 to 65535.
- **Data Source**
Indicates the port ID which wants to be monitored. If in stacking switch, the value must add 1000*(switch ID-1), for example, if the port is switch 3 port 5, the value is 2005
- **Interval**
Indicates the interval in seconds for sampling the history statistics data. The range is from 1 to 3600, default value is 1800 seconds.
- **Buckets**
Indicates the maximum data entries associated this History control entry stored in RMON. The range is from 1 to 3600, default value is 50.
- **Buckets Granted**

The number of data shall be saved in the RMON.

3-5.1.7.3 Alarm

Configure RMON Alarm table on this page. The entry index key is **ID**.

Web Interface

To display the configure RMON Alarm in the web interface:

1. Click RMON, Alarm.
2. Click Add New Entry.
3. Specify the ID parameters.
4. Click Apply.

Figure 3-5.1.7.3: The RMON Alarm Configuration

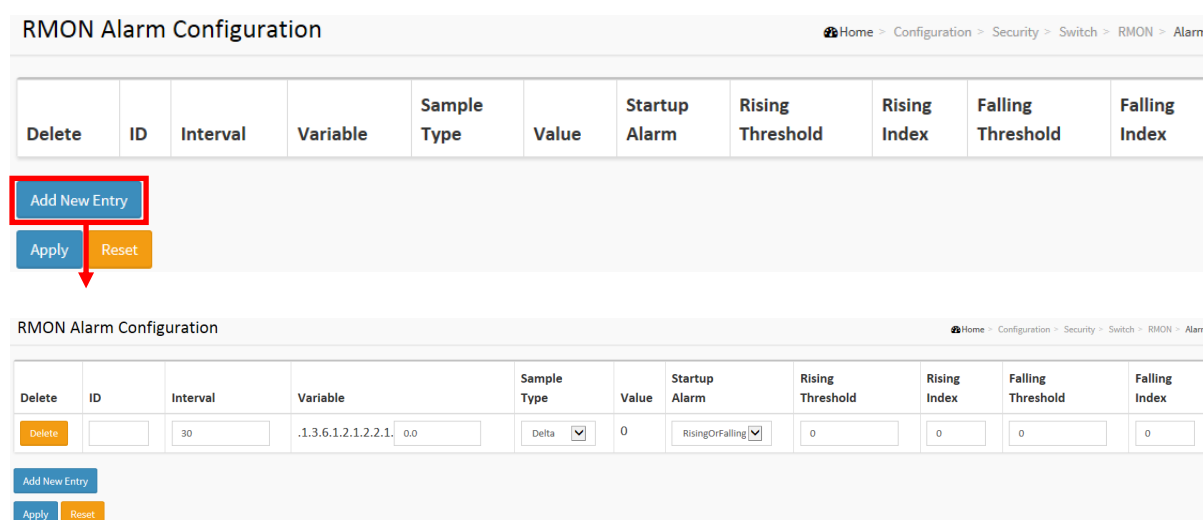

Parameter description:

These parameters are displayed on the RMON Alarm Configuration page:

- **Delete**
Check to delete the entry. It will be deleted during the next save.
- **ID**
Indicates the index of the entry. The range is from 1 to 65535.
- **Interval**
Indicates the interval in seconds for sampling and comparing the rising and falling threshold. The range is from 1 to $2^{31}-1$.
- **Variable**
Indicates the particular variable to be sampled, the possible variables are:
 - InOctets:**
The total number of octets received on the interface, including framing characters.
 - InUcastPkts:**
The number of uni-cast packets delivered to a higher-layer protocol.
 - InNUcastPkts:**
The number of broad-cast and multi-cast packets delivered to a higher-layer protocol.
 - InDiscards:**

The number of inbound packets that are discarded even the packets are normal.

InErrors:

The number of inbound packets that contained errors preventing them from being deliverable to a higher-layer protocol.

InUnknownProtos:

the number of the inbound packets that were discarded because of the unknown or un-support protocol.

OutOctets:

The number of octets transmitted out of the interface , including framing characters.

OutUcastPkts:

The number of uni-cast packets that request to transmit.

OutNUcastPkts:

The number of broad-cast and multi-cast packets that request to transmit.

OutDiscards:

The number of outbound packets that are discarded event the packets is normal.

OutErrors:

The The number of outbound packets that could not be transmitted because of errors.

OutQLen:

The length of the output packet queue (in packets).

- **Sample Type**

The method of sampling the selected variable and calculating the value to be compared against the thresholds, possible sample types are:

Absolute: Get the sample directly.

Delta: Calculate the difference between samples (default).

- **Value**

The value of the statistic during the last sampling period.

- **Startup Alarm**

The method of sampling the selected variable and calculating the value to be compared against the thresholds, possible sample types are:

RisingTrigger alarm when the first value is larger than the rising threshold.

FallingTrigger alarm when the first value is less than the falling threshold.

RisingOrFallingTrigger alarm when the first value is larger than the rising threshold or less than the falling threshold (default).

- **Rising Threshold**

Rising threshold value (-2147483648-2147483647).

- **Rising Index**

Rising event index (1-65535).

- **Falling Threshold**

Falling threshold value (-2147483648-2147483647)

- **Falling Index**

Falling event index (1-65535).

3-5.1.7.4 Event

Configure RMON Event table on this page. The entry index key is **ID**.

Web Interface

To display the configure RMON Event in the web interface:

1. Click RMON, Event.
2. Click Add New Entry.
3. Specify the ID parameters.
4. Click Apply.

Figure 3-5.1.8.4: The RMON Event Configuration

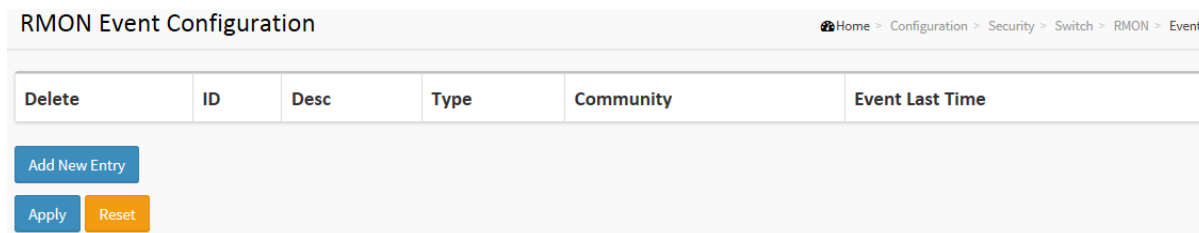

Parameter description:

These parameters are displayed on the RMON History Configuration page:

- **Delete**
Check to delete the entry. It will be deleted during the next save.
- **ID**
Indicates the index of the entry. The range is from 1 to 65535.
- **Desc**
Indicates this event, the string length is from 0 to 127, default is a null string.
- **Type**
Indicates the notification of the event, the possible types are:
 - none**: No SNMP log is created, no SNMP trap is sent.
 - log**: Create SNMP log entry when the event is triggered.
 - snmptrap**: Send SNMP trap when the event is triggered.
 - logandtrap**: Create SNMP log entry and sent SNMP trap when the event is triggered.
- **Community**
Specify the community when trap is sent, the string length is from 0 to 127, default is "public".
- **Event Last Time**
Indicates the value of sysUpTime at the time this event entry last generated an event.

3-5.2 Network

3-5.2.1 Limit Control

This section shows you to to configure the Port Security settings of the Switch. You can use the Port Security feature to restrict input to an interface by limiting and identifying MAC addresses.

Web Interface

To configure a Configuration of Limit Control in the web interface:

1. Select "Enabled" in the Mode of System Configuration.
2. Checked Aging Enabled.
3. Set Aging Period (Default is 3600 seconds).

To configure a Port Configuration of Limit Control in the web interface:

1. Select "Enabled" in the Mode of Port Configuration.
2. Specify the maximum number of MAC addresses in the Limit of Port Configuration.
3. Set Action (Trap, Shutdown, Trap & Shutdown)
4. Click Apply.

Figure 3-5.2.1: The Port Security Limit Control Configuration

Port Security Limit Control ConfigurationHome > Configuration > Security > Network > Limit Control



System Configuration

Mode	Disabled <input type="button" value="v"/>
Aging Enabled	<input type="checkbox"/>
Aging Period	<input type="text" value="3600"/> seconds

Port Configuration

Port	Mode	Limit	Action	State	Re-open
*	<input type="button" value="v"/>	<input type="text" value="4"/>	<input type="button" value="v"/>		
1	Disabled <input type="button" value="v"/>	<input type="text" value="4"/>	None <input type="button" value="v"/>	Disabled	<input type="button" value="Reopen"/>
2	Disabled <input type="button" value="v"/>	<input type="text" value="4"/>	None <input type="button" value="v"/>	Disabled	<input type="button" value="Reopen"/>
3	Disabled <input type="button" value="v"/>	<input type="text" value="4"/>	None <input type="button" value="v"/>	Disabled	<input type="button" value="Reopen"/>
4	Disabled <input type="button" value="v"/>	<input type="text" value="4"/>	None <input type="button" value="v"/>	Disabled	<input type="button" value="Reopen"/>

21	Disabled <input type="checkbox"/>	4	None <input type="checkbox"/>	Disabled	Reopen
22	Disabled <input type="checkbox"/>	4	None <input type="checkbox"/>	Disabled	Reopen
23	Disabled <input type="checkbox"/>	4	None <input type="checkbox"/>	Disabled	Reopen
24	Disabled <input type="checkbox"/>	4	None <input type="checkbox"/>	Disabled	Reopen
25	Disabled <input type="checkbox"/>	4	None <input type="checkbox"/>	Disabled	Reopen
26	Disabled <input type="checkbox"/>	4	None <input type="checkbox"/>	Disabled	Reopen

Apply Reset

Parameter description:

System Configuration

- **Mode :**

Indicates if Limit Control is globally enabled or disabled on the switch. If globally disabled, other modules may still use the underlying functionality, but limit checks and corresponding actions are disabled.

- **Aging Enabled :**

If checked, secured MAC addresses are subject to aging as discussed under Aging Period .

- **Aging Period :**

If Aging Enabled is checked, then the aging period is controlled with this input. If other modules are using the underlying port security for securing MAC addresses, they may have other requirements to the aging period. The underlying port security will use the shorter requested aging period of all modules that use the functionality.

The Aging Period can be set to a number between 10 and 10,000,000 seconds.

To understand why aging may be desired, consider the following scenario: Suppose an end-host is connected to a 3rd party switch or hub, which in turn is connected to a port on this switch on which Limit Control is enabled. The end-host will be allowed to forward if the limit is not exceeded. Now suppose that the end-host logs off or powers down. If it wasn't for aging, the end-host would still take up resources on this switch and will be allowed to forward. To overcome this situation, enable aging. With aging enabled, a timer is started once the end-host gets secured. When the timer expires, the switch starts looking for frames from the end-host, and if such frames are not seen within the next Aging Period, the end-host is assumed to be disconnected, and the corresponding resources are freed on the switch.

Port Configuration

The table has one row for each port on the selected switch and a number of columns, which are:

- **Port :**

The port number to which the configuration below applies.

- **Mode :**

Controls whether Limit Control is enabled on this port. Both this and the Global Mode must be set to Enabled for Limit Control to be in effect. Notice that other modules may still use the underlying port security features without enabling Limit Control on a given port.

- **Limit :**

The maximum number of MAC addresses that can be secured on this port. This number cannot exceed 1024. If the limit is exceeded, the corresponding action is taken.

The switch is "born" with a total number of MAC addresses from which all ports draw whenever a new MAC address is seen on a Port Security-enabled port. Since all ports draw from the same pool, it may happen that a configured maximum cannot be granted, if the remaining ports have already used all available MAC addresses.

- **Action :**

If Limit is reached, the switch can take one of the following actions:

None: Do not allow more than Limit MAC addresses on the port, but take no further action.

Trap: If Limit + 1 MAC addresses is seen on the port, send an SNMP trap. If Aging is disabled, only one SNMP trap will be sent, but with Aging enabled, new SNMP traps will be sent every time the limit gets exceeded.

Shutdown: If Limit + 1 MAC addresses is seen on the port, shut down the port. This implies that all secured MAC addresses will be removed from the port, and no new address will be learned. Even if the link is physically disconnected and reconnected on the port (by disconnecting the cable), the port will remain shut down. There are three ways to re-open

the port:

- 1) Boot the switch,
- 2) Disable and re-enable Limit Control on the port or the switch,
- 3) Click the Reopen button.

Trap & Shutdown: If Limit + 1 MAC addresses is seen on the port, both the "Trap" and the "Shutdown" actions described above will be taken.

- **State :**

This column shows the current state of the port as seen from the Limit Control's point of view. The state takes one of four values:

Disabled: Limit Control is either globally disabled or disabled on the port.

Ready: The limit is not yet reached. This can be shown for all actions.

Limit Reached: Indicates that the limit is reached on this port. This state can only be shown if Action is set to None or Trap.

Shutdown: Indicates that the port is shut down by the Limit Control module. This state can only be shown if Action is set to Shutdown or Trap & Shutdown.

- **Re-open Button :**

If a port is shutdown by this module, you may reopen it by clicking this button, which will only be enabled if this is the case. For other methods, refer to Shutdown in the Action section.



NOTE: That clicking the reopen button causes the page to be refreshed, so non-committed changes will be lost

- **Upper right icon (Refresh):**

You can click them for refresh the Port Security information by manual.

- **Buttons:**

Apply – Click to save changes.

Reset- Click to undo any changes made locally and revert to previously saved values.

3-5.2.2 NAS

The section describes to configure the NAS parameters of the switch. The NAS server can be employed to connect users to a variety of resources including Internet access, conference calls, printing documents on shared printers, or by simply logging on to the Internet.

Web Interface

To configure a Network Access Server in the web interface:

1. Select "Enabled" in the Mode of Network Access Server Configuration.
2. Checked Reauthentication Enabled.
3. Set Reauthentication Period (Default is 3600 seconds).
4. Set EAPOL Timeout (Default is 30 seconds).
5. Set Aging Period (Default is 300 seconds).
6. Set Hold Time (Default is 10 seconds).
7. Checked RADIUS-Assigned QoS Enabled.
8. Checked RADIUS-Assigned VLAN Enabled.
9. Checked Guest VLAN Enabled.
10. Specify Guest VLAN ID.
11. Specify Max. Reauth. Count.
12. Checked Allow Guest VLAN if EAPOL Seen.
13. Click Apply.

Figure 3-5.2.2: The Network Access Server Configuration

System Configuration	
Mode	Disabled <input type="button" value="v"/>
Reauthentication Enabled	<input type="checkbox"/>
Reauthentication Period	<input type="text" value="3600"/> seconds
EAPOL Timeout	<input type="text" value="30"/> seconds
Aging Period	<input type="text" value="300"/> seconds
Hold Time	<input type="text" value="10"/> seconds
RADIUS-Assigned QoS Enabled	<input type="checkbox"/>
RADIUS-Assigned VLAN Enabled	<input type="checkbox"/>
Guest VLAN Enabled	<input type="checkbox"/>
Guest VLAN ID	<input type="text" value="1"/>
Max. Reauth. Count	<input type="text" value="2"/>
Allow Guest VLAN if EAPOL Seen	<input type="checkbox"/>

Port Configuration						
Port	Admin State	RADIUS-Assigned QoS Enabled	RADIUS-Assigned VLAN Enabled	Guest VLAN Enabled	Port State	Restart
*	<input type="button" value="v"/>	<input type="checkbox"/>	<input type="checkbox"/>	<input type="checkbox"/>		
1	Force Authorized <input type="button" value="v"/>	<input type="checkbox"/>	<input type="checkbox"/>	<input type="checkbox"/>	Globally Disabled	<input type="button" value="Reauthenticate"/> <input type="button" value="Reinitialize"/>
2	Force Authorized <input type="button" value="v"/>	<input type="checkbox"/>	<input type="checkbox"/>	<input type="checkbox"/>	Globally Disabled	<input type="button" value="Reauthenticate"/> <input type="button" value="Reinitialize"/>

24	Force Authorized <input type="checkbox"/>	<input type="checkbox"/>	<input type="checkbox"/>	<input type="checkbox"/>	Globally Disabled	Reauthenticate	Reinitialize
25	Force Authorized <input type="checkbox"/>	<input type="checkbox"/>	<input type="checkbox"/>	<input type="checkbox"/>	Globally Disabled	Reauthenticate	Reinitialize
26	Force Authorized <input type="checkbox"/>	<input type="checkbox"/>	<input type="checkbox"/>	<input type="checkbox"/>	Globally Disabled	Reauthenticate	Reinitialize

Apply Reset

Parameter description:

- **Mode :**

Indicates if NAS is globally enabled or disabled on the switch. If globally disabled, all ports are allowed forwarding of frames.

- **Reauthentication Enabled :**

If checked, successfully authenticated supplicants/clients are reauthenticated after the interval specified by the Reauthentication Period. Reauthentication for 802.1X-enabled ports can be used to detect if a new device is plugged into a switch port or if a supplicant is no longer attached.

For MAC-based ports, reauthentication is only useful if the RADIUS server configuration has changed. It does not involve communication between the switch and the client, and therefore doesn't imply that a client is still present on a port (see Aging Period below).

- **Reauthentication Period :**

Determines the period, in seconds, after which a connected client must be reauthenticated. This is only active if the Reauthentication Enabled checkbox is checked. Valid values are in the range 1 to 3600 seconds.

- **EAPOL Timeout :**

Determines the time for retransmission of Request Identity EAPOL frames.

Valid values are in the range 1 to 255 seconds. This has no effect for MAC-based ports.

- **Aging Period :**

This setting applies to the following modes, i.e. modes using the Port Security functionality to secure MAC addresses:

- **Single 802.1X**
- **Multi 802.1X**
- **MAC-Based Auth.**

When the NAS module uses the Port Security module to secure MAC addresses, the Port Security module needs to check for activity on the MAC address in question at regular intervals and free resources if no activity is seen within a given period of time. This parameter controls exactly this period and can be set to a number between 10 and 1000000 seconds.

If reauthentication is enabled and the port is in an 802.1X-based mode, this is not so critical, since supplicants that are no longer attached to the port will get removed upon the next reauthentication, which will fail. But if reauthentication is not enabled, the only way to free resources is by aging the entries.

For ports in MAC-based Auth. mode, reauthentication doesn't cause direct communication between the switch and the client, so this will not detect whether the client is still attached or not, and the only way to free any resources is to age the entry.

- **Hold Time :**

This setting applies to the following modes, i.e. modes using the Port Security functionality to secure MAC addresses:

- **Single 802.1X**
- **Multi 802.1X**

- **MAC-Based Auth.**

If a client is denied access - either because the RADIUS server denies the client access or because the RADIUS server request times out (according to the timeout specified on the "Configuration→Security→AAA" page) - the client is put on hold in the Unauthorized state. The hold timer does not count during an on-going authentication.

In MAC-based Auth. mode, the The switch will ignore new frames coming from the client during the hold time.

The Hold Time can be set to a number between 10 and 1000000 seconds.

- **RADIUS-Assigned QoS Enabled :**

RADIUS-assigned QoS provides a means to centrally control the traffic class to which traffic coming from a successfully authenticated supplicant is assigned on the switch. The RADIUS server must be configured to transmit special RADIUS attributes to take advantage of this feature (see RADIUS-Assigned QoS Enabled below for a detailed description)

The "RADIUS-Assigned QoS Enabled" checkbox provides a quick way to globally enable/disable RADIUS-server assigned QoS Class functionality. When checked, the individual ports' ditto setting determine whether RADIUS-assigned QoS Class is enabled on that port. When unchecked, RADIUS-server assigned QoS Class is disabled on all ports.

- **RADIUS-Assigned VLAN Enabled :**

RADIUS-assigned VLAN provides a means to centrally control the VLAN on which a successfully authenticated supplicant is placed on the switch. Incoming traffic will be classified to and switched on the RADIUS-assigned VLAN. The RADIUS server must be configured to transmit special RADIUS attributes to take advantage of this feature (see RADIUS-Assigned VLAN Enabled below for a detailed description).

The "RADIUS-Assigned VLAN Enabled" checkbox provides a quick way to globally enable/disable RADIUS-server assigned VLAN functionality. When checked, the individual ports' ditto setting determine whether RADIUS-assigned VLAN is enabled on that port. When unchecked, RADIUS-server assigned VLAN is disabled on all ports.

- **Guest VLAN Enabled :**

A Guest VLAN is a special VLAN - typically with limited network access - on which 802.1X-unaware clients are placed after a network administrator-defined timeout. The switch follows a set of rules for entering and leaving the Guest VLAN as listed below.

The "Guest VLAN Enabled" checkbox provides a quick way to globally enable/disable Guest VLAN functionality. When checked, the individual ports' ditto setting determines whether the port can be moved into Guest VLAN. When unchecked, the ability to move to the Guest VLAN is disabled on all ports.

- **Guest VLAN ID :**

This is the value that a port's Port VLAN ID is set to if a port is moved into the Guest VLAN. It is only changeable if the Guest VLAN option is globally enabled.

Valid values are in the range [1; 4095].

- **Max. Reauth. Count :**

The number of times the switch transmits an EAPOL Request Identity frame without response before considering entering the Guest VLAN is adjusted with this setting. The value can only be changed if the Guest VLAN option is globally enabled.

Valid values are in the range [1; 255].

- **Allow Guest VLAN if EAPOL Seen :**

The switch remembers if an EAPOL frame has been received on the port for the life-time of the port. Once the switch considers whether to enter the Guest VLAN, it will first check if this option is enabled or disabled. If disabled (unchecked; default), the switch will only enter the Guest VLAN if an EAPOL frame has not been received on the port for the life-time of the port. If enabled (checked), the switch will consider entering the Guest VLAN even if an EAPOL frame has been received on the port for the life-time of the port.

The value can only be changed if the Guest VLAN option is globally enabled.

- **Port Configuration :**

The table has one row for each port on the selected switch and a number of columns, which are:

- **Port :**

The port number for which the configuration below applies.

- **Admin State :**

If NAS is globally enabled, this selection controls the port's authentication mode. The following modes are available:

- **Force Authorized :**

In this mode, the switch will send one EAPOL Success frame when the port link comes up, and any client on the port will be allowed network access without authentication.

- **Force Unauthorized :**

In this mode, the switch will send one EAPOL Failure frame when the port link comes up, and any client on the port will be disallowed network access.

- **Port-based 802.1X :**

In the 802.1X-world, the user is called the supplicant, the switch is the authenticator, and the RADIUS server is the authentication server. The authenticator acts as the man-in-the-middle, forwarding requests and responses between the supplicant and the authentication server. Frames sent between the supplicant and the switch are special 802.1X frames, known as EAPOL (EAP Over LANs) frames. EAPOL frames encapsulate EAP PDUs (RFC3748). Frames sent between the switch and the RADIUS server are RADIUS packets. RADIUS packets also encapsulate EAP PDUs together with other attributes like the switch's IP address, name, and the supplicant's port number on the switch. EAP is very flexible, in that it allows for different authentication methods, like MD5-Challenge, PEAP, and TLS. The important thing is that the authenticator (the switch) doesn't need to know which authentication method the supplicant and the authentication server are using, or how many information exchange frames are needed for a particular method. The switch simply encapsulates the EAP part of the frame into the relevant type (EAPOL or RADIUS) and forwards it.

When authentication is complete, the RADIUS server sends a special packet containing a success or failure indication. Besides forwarding this decision to the supplicant, the switch uses it to open up or block traffic on the switch port connected to the supplicant



NOTE: Suppose two backend servers are enabled and that the server timeout is configured to X seconds (using the AAA configuration page), and suppose that the first server in the list is currently down (but not considered dead).

Now, if the supplicant retransmits EAPOL Start frames at a rate faster than X seconds, then it will never get authenticated, because the switch will cancel on-going backend authentication server requests whenever it receives a new EAPOL Start frame from the supplicant.

And since the server hasn't yet failed (because the X seconds haven't expired), the same server will be contacted upon the next backend authentication server request from the switch. This scenario will loop forever. Therefore, the server timeout should be smaller than the supplicant's EAPOL Start frame retransmission rate.

- **Single 802.1X :**

In port-based 802.1X authentication, once a supplicant is successfully authenticated on a

port, the whole port is opened for network traffic. This allows other clients connected to the port (for instance through a hub) to piggy-back on the successfully authenticated client and get network access even though they really aren't authenticated. To overcome this security breach, use the Single 802.1X variant. Single 802.1X is really not an IEEE standard, but features many of the same characteristics as does port-based 802.1X. In Single 802.1X, at most one supplicant can get authenticated on the port at a time. Normal EAPOL frames are used in the communication between the supplicant and the switch. If more than one supplicant is connected to a port, the one that comes first when the port's link comes up will be the first one considered. If that supplicant doesn't provide valid credentials within a certain amount of time, another supplicant will get a chance. Once a supplicant is successfully authenticated, only that supplicant will be allowed access. This is the most secure of all the supported modes. In this mode, the Port Security module is used to secure a supplicant's MAC address once successfully authenticated.

- **Multi 802.1X :**

In port-based 802.1X authentication, once a supplicant is successfully authenticated on a port, the whole port is opened for network traffic. This allows other clients connected to the port (for instance through a hub) to piggy-back on the successfully authenticated client and get network access even though they really aren't authenticated. To overcome this security breach, use the Multi 802.1X variant.

Multi 802.1X is really not an IEEE standard, but features many of the same characteristics as does port-based 802.1X. Multi 802.1X is - like Single 802.1X - not an IEEE standard, but a variant that features many of the same characteristics. In Multi 802.1X, one or more supplicants can get authenticated on the same port at the same time. Each supplicant is authenticated individually and secured in the MAC table using the Port Security module.

In Multi 802.1X it is not possible to use the multicast BPDU MAC address as destination MAC address for EAPOL frames sent from the switch towards the supplicant, since that would cause all supplicants attached to the port to reply to requests sent from the switch. Instead, the switch uses the supplicant's MAC address, which is obtained from the first EAPOL Start or EAPOL Response Identity frame sent by the supplicant. An exception to this is when no supplicants are attached. In this case, the switch sends EAPOL Request Identity frames using the BPDU multicast MAC address as destination - to wake up any supplicants that might be on the port.

The maximum number of supplicants that can be attached to a port can be limited using the Port Security Limit Control functionality.

- **MAC-based Auth.:**

Unlike port-based 802.1X, MAC-based authentication is not a standard, but merely a best-practices method adopted by the industry. In MAC-based authentication, users are called clients, and the switch acts as the supplicant on behalf of clients. The initial frame (any kind of frame) sent by a client is snooped by the switch, which in turn uses the client's MAC address as both username and password in the subsequent EAP exchange with the RADIUS server. The 6-byte MAC address is converted to a string on the following form "xx-xx-xx-xx-xx-xx", that is, a dash (-) is used as separator between the lower-cased hexadecimal digits. The switch only supports the MD5-Challenge authentication method, so the RADIUS server must be configured accordingly.

When authentication is complete, the RADIUS server sends a success or failure indication, which in turn causes the switch to open up or block traffic for that particular client, using the Port Security module. Only then will frames from the client be forwarded on the switch. There are no EAPOL frames involved in this authentication, and therefore, MAC-based Authentication has nothing to do with the 802.1X standard.

The advantage of MAC-based authentication over port-based 802.1X is that several clients can be connected to the same port (e.g. through a 3rd party switch or a hub) and still require individual authentication, and that the clients don't need special supplicant software to authenticate. The advantage of MAC-based authentication over 802.1X-based authentication is that the clients don't need special supplicant software to authenticate. The disadvantage is that MAC addresses can be spoofed by malicious users - equipment whose MAC address is a valid RADIUS user can be used by anyone. Also, only the MD5-Challenge method is supported. The maximum number of clients that can be attached to a port can be limited using the Port Security Limit Control functionality.

- **RADIUS-Assigned QoS Enabled :**

When RADIUS-Assigned QoS is both globally enabled and enabled (checked) on a given port, the switch reacts to QoS Class information carried in the RADIUS Access-Accept packet transmitted by the RADIUS server when a supplicant is successfully authenticated. If present and valid, traffic received on the supplicant's port will be classified to the given QoS Class. If (re-)authentication fails or the RADIUS Access-Accept packet no longer carries a QoS Class or it's invalid, or the supplicant is otherwise no longer present on the port, the port's QoS Class is immediately reverted to the original QoS Class (which may be changed by the administrator in the meanwhile without affecting the RADIUS-assigned).

This option is only available for single-client modes, i.e.

- **Port-based 802.1X**

- **Single 802.1X**

RADIUS attributes used in identifying a QoS Class:

Refer to the written documentation for a description of the RADIUS attributes needed in order to successfully identify a QoS Class. The User-Priority-Table attribute defined in RFC4675 forms the basis for identifying the QoS Class in an Access-Accept packet.

Only the first occurrence of the attribute in the packet will be considered, and to be valid, it must follow this rule:

- All 8 octets in the attribute's value must be identical and consist of ASCII characters in the range '0' - '3', which translates into the desired QoS Class in the range [0; 3].

- **RADIUS-Assigned VLAN Enabled :**

When RADIUS-Assigned VLAN is both globally enabled and enabled (checked) for a given port, the switch reacts to VLAN ID information carried in the RADIUS Access-Accept packet transmitted by the RADIUS server when a supplicant is successfully authenticated. If present and valid, the port's Port VLAN ID will be changed to this VLAN ID, the port will be set to be a member of that VLAN ID, and the port will be forced into VLAN unaware mode. Once assigned, all traffic arriving on the port will be classified and switched on the RADIUS-assigned VLAN ID.

If (re-)authentication fails or the RADIUS Access-Accept packet no longer carries a VLAN ID or it's invalid, or the supplicant is otherwise no longer present on the port, the port's VLAN ID is immediately reverted to the original VLAN ID (which may be changed by the administrator in the meanwhile without affecting the RADIUS-assigned).

This option is only available for single-client modes, i.e.

- **Port-based 802.1X**

- **Single 802.1X**

For trouble-shooting VLAN assignments, use the "Monitor→VLANs→VLAN Membership and VLAN Port" pages. These pages show which modules have (temporarily) overridden the current Port VLAN configuration.

RADIUS attributes used in identifying a VLAN ID:

RFC2868 and RFC3580 form the basis for the attributes used in identifying a VLAN ID in an Access-Accept packet. The following criteria are used:

- The Tunnel-Medium-Type, Tunnel-Type, and Tunnel-Private-Group-ID attributes must all be present at least once in the Access-Accept packet.
- The switch looks for the first set of these attributes that have the same Tag value and fulfil the following requirements (if Tag == 0 is used, the Tunnel-Private-Group-ID does not need to include a Tag):
 - Value of Tunnel-Medium-Type must be set to "IEEE-802" (ordinal 6).
 - Value of Tunnel-Type must be set to "VLAN" (ordinal 13).
 - Value of Tunnel-Private-Group-ID must be a string of ASCII chars in the range '0' - '9', which is interpreted as a decimal string representing the VLAN ID. Leading '0's are discarded. The final value must be in the range [1; 4095].

- **Guest VLAN Enabled :**

When Guest VLAN is both globally enabled and enabled (checked) for a given port, the switch considers moving the port into the Guest VLAN according to the rules outlined below.

This option is only available for EAPOL-based modes, i.e.:

- **Port-based 802.1X**

- **Single 802.1X**

- **Multi 802.1X**

For trouble-shooting VLAN assignments, use the "Monitor→VLANs→VLAN Membership and VLAN Port" pages. These pages show which modules have (temporarily) overridden the current Port VLAN configuration.

Guest VLAN Operation:

When a Guest VLAN enabled port's link comes up, the switch starts transmitting EAPOL Request Identity frames. If the number of transmissions of such frames exceeds Max. Reauth. Count and no EAPOL frames have been received in the meanwhile, the switch considers entering the Guest VLAN. The interval between transmission of EAPOL Request Identity frames is configured with EAPOL Timeout. If Allow Guest VLAN if EAPOL Seen is enabled, the port will now be placed in the Guest VLAN. If disabled, the switch will first check its history to see if an EAPOL frame has previously been received on the port (this history is cleared if the port link goes down or the port's Admin State is changed), and if not, the port will be placed in the Guest VLAN. Otherwise it will not move to the Guest VLAN, but continue transmitting EAPOL Request Identity frames at the rate given by EAPOL Timeout.

Once in the Guest VLAN, the port is considered authenticated, and all attached clients on the port are allowed access on this VLAN. The switch will not transmit an EAPOL Success frame when entering the Guest VLAN.

While in the Guest VLAN, the switch monitors the link for EAPOL frames, and if one such frame is received, the switch immediately takes the port out of the Guest VLAN and starts authenticating the supplicant according to the port mode. If an EAPOL frame is received, the port will never be able to go back into the Guest VLAN if the "Allow Guest VLAN if EAPOL Seen" is disabled.

- **Port State :**

The current state of the port. It can undertake one of the following values:

Globally Disabled: NAS is globally disabled.

Link Down: NAS is globally enabled, but there is no link on the port.

Authorized: The port is in Force Authorized or a single-supplicant mode and the supplicant is authorized.

Unauthorized: The port is in Force Unauthorized or a single-supplicant mode and the supplicant is not successfully authorized by the RADIUS server.

X Auth/Y Unauth: The port is in a multi-supplicant mode. Currently X clients are authorized and Y are unauthorized.

- **Restart :**

Two buttons are available for each row. The buttons are only enabled when authentication is globally enabled and the port's Admin State is in an EAPOL-based or MAC-based mode.

Clicking these buttons will not cause settings changed on the page to take effect.

Reauthenticate: Schedules a reauthentication whenever the quiet-period of the port runs out (EAPOL-based authentication). For MAC-based authentication, reauthentication will be attempted immediately.

The button only has effect for successfully authenticated clients on the port and will not cause the clients to get temporarily unauthorized.

Reinitialize: Forces a reinitialization of the clients on the port and thereby a reauthentication immediately. The clients will transfer to the unauthorized state while the reauthentication is in progress.

- **Buttons:**

Apply – Click to save changes.

Reset- Click to undo any changes made locally and revert to previously saved values.

- **Upper right icon (Refresh):**

You can click them for refresh the NAS Configuration by manual.

3-5.2.3 ACL

The switch access control list (ACL) is probably the most commonly used object in the IOS. It is used for packet filtering but also for selecting types of traffic to be analyzed, forwarded, or influenced in some way. The ACLs are divided into Ether Types. IPv4, ARP protocol, MAC and VLAN parameters etc. Here we will just go over the standard and extended access lists for TCP/IP. As you create ACEs for ingress classification, you can assign a policy for each port, the policy number is 1-8, however, each policy can be applied to any port. This makes it very easy to determine what type of ACL policy you will be working with.

3-5.2.3.1 Ports

The section describes how to configure the ACL parameters (ACE) of the each switch port. These parameters will affect frames received on a port unless the frame matches a specific ACE

Web Interface

To configure the ACL Ports Configuration in the web interface:

1. Click Configuration, ACL, then Ports
2. To scroll the specific parameter value to select the correct value for port ACL setting.
3. Click the save to save the setting
4. If you want to cancel the setting then you need to click the reset button. It will revert to previously saved values.
5. After you configure complete then you could see the Counter of the port. Then you could click refresh to update the counter or Clear the information.

Figure 3-5.2.3.1: The ACL Ports Configuration

ACL Ports Configuration Home > Configuration > Security > Network > ACL > Ports

Port	Policy ID	Action	Rate Limiter ID	Port Redirect	Mirror	Logging	Shutdown	State	Counter
*	0	<> ▾	<> ▾	Disabled Port 1 Port 2	<> ▾	<> ▾	<> ▾	<> ▾	*
1	0	Permit ▾	Disabled ▾	Disabled Port 1 Port 2	Disabled ▾	Disabled ▾	Disabled ▾	Enabled ▾	6678
2	0	Permit ▾	Disabled ▾	Disabled Port 1 Port 2	Disabled ▾	Disabled ▾	Disabled ▾	Enabled ▾	0
25	0	Permit ▾	Disabled ▾	Disabled Port 1 Port 2	Disabled ▾	Disabled ▾	Disabled ▾	Enabled ▾	0
26	0	Permit ▾	Disabled ▾	Disabled Port 1 Port 2	Disabled ▾	Disabled ▾	Disabled ▾	Enabled ▾	0

Apply Reset

Parameter description:

- **Port :**

The logical port for the settings contained in the same row.
- **Policy ID :**

Select the policy to apply to this port. The allowed values are 1 through 8. The default value is 1.
- **Action :**

Select whether forwarding is permitted ("Permit") or denied ("Deny"). The default value is "Permit".
- **Rate Limiter ID :**

Select which rate limiter to apply on this port. The allowed values are Disabled or the values 1 through 16. The default value is "Disabled".
- **Port Redirect :**

Select which port frames are redirected on. The allowed values are Disabled or a specific port number and it can't be set when action is permitted. The default value is "Disabled".
- **Mirror :**

Specify the mirror operation of this port. The allowed values are:
Enabled: Frames received on the port are mirrored.
Disabled: Frames received on the port are not mirrored.
The default value is "Disabled".
- **Logging :**

Specify the logging operation of this port. The allowed values are:
Enabled: Frames received on the port are stored in the System Log.
Disabled: Frames received on the port are not logged.
The default value is "Disabled". Please note that the System Log memory size and logging rate is limited.
- **Shutdown :**

Specify the port shut down operation of this port. The allowed values are:
Enabled: If a frame is received on the port, the port will be disabled.
Disabled: Port shut down is disabled.
The default value is "Disabled".
- **State :**

Specify the port state of this port. The allowed values are:
Enabled: To reopen ports by changing the volatile port configuration of the ACL user module.
Disabled: To close ports by changing the volatile port configuration of the ACL user module.
The default value is "Enabled"
- **Counter :**

Counts the number of frames that match this ACE.
- **Buttons**

Apply – Click to save changes.

Reset- Click to undo any changes made locally and revert to previously saved values.

- **Upper right icon (Refresh, clear)**

You can click them for refresh the ACL Port Configuration or clear them by manual.

3-5.2.3.2 Rate Limiters

The section describes how to configure the switch's ACL Rate Limiter parameters. The Rate Limiter Level from 1 to 16 that allow user to set rate limiter value and units with pps or kbps.

Web Interface

To configure ACL Rate Limiter in the web interface:

1. Click Configuration, ACL, then Rate Limiter
2. To specific the Rate field and the range from 0 to 3276700.
3. To scroll the Unit with pps or kbps
4. Click the Apply to save the setting
5. If you want to cancel the setting then you need to click the reset button. It will revert to previously saved values.

Figure 3-5.2.3.2: The ACL Rate Limiter Configuration

ACL Rate Limiter Configuration Home > Configuration > Security > Network > ACL > Rate Limiters

Rate Limiter ID	Rate	Unit
*	<input type="text" value="1"/>	<input type="text" value="<"/>
1	<input type="text" value="1"/>	pps <input type="text" value="v"/>
2	<input type="text" value="1"/>	pps <input type="text" value="v"/>
3	<input type="text" value="1"/>	pps <input type="text" value="v"/>
13	<input type="text" value="1"/>	pps <input type="text" value="v"/>
14	<input type="text" value="1"/>	pps <input type="text" value="v"/>
15	<input type="text" value="1"/>	pps <input type="text" value="v"/>
16	<input type="text" value="1"/>	pps <input type="text" value="v"/>

Parameter description:

- **Rate Limiter ID :**

The rate limiter ID for the settings contained in the same row.

- **Rate**

The allowed values are: 0-3276700 in pps or 0, 100, 200, 300, ..., 1000000 in kbps.

- **Unit :**

Specify the rate unit. The allowed values are:

pps: packets per second.

kbps: Kbits per second.

- **Buttons**

Apply – Click to save changes.

Reset - Click to undo any changes made locally and revert to previously saved values.

3-5.2.3.3 Access Control List

The section describes how to configure Access Control List rule. An Access Control List (ACL) is a sequential list of permit or deny conditions that apply to IP addresses, MAC addresses, or other more specific criteria. This switch tests ingress packets against the conditions in an ACL one by one. A packet will be accepted as soon as it matches a permit rule, or dropped as soon as it matches a deny rule. If no rules match, the frame is accepted. Other actions can also be invoked when a matching packet is found, including rate limiting, copying matching packets to another port or to the system log, or shutting down a port.

This page shows the Access Control List (ACL), which is made up of the ACEs defined on this switch. Each row describes the ACE that is defined. The maximum number of ACEs is 256 on each switch. Click on the lowest plus sign to add a new ACE to the list. The reserved ACEs used for internal protocol, cannot be edited or deleted, the order sequence cannot be changed the priority is highest

Web Interface

To configure Access Control List in the web interface:

1. Click Configuration, ACL, then Configuration
2. Click the  button to add a new ACL, or use the other ACL modification buttons to specify the editing action (i.e., edit, delete, or moving the relative position of entry in the list)
3. To specific the parameter of the ACE
4. Click the save to save the setting
5. If you want to cancel the setting then you need to click the reset button. It will revert to previously saved values.
6. When editing an entry on the ACE Configuration page, note that the Items displayed depend on various selections, such as Frame Type and IP Protocol Type. Specify the relevant criteria to be matched for this rule, and set the actions to take when a rule is matched (such as Rate Limiter, Port Copy, Logging, and Shutdown).

Figure 3-5.2.3.3: The ACL Rate Limiter Configuration



Ingress Port	<input type="button" value="All"/> <input type="button" value="Port 1"/> <input type="button" value="Port 2"/> <input type="button" value="Port 3"/> <input type="button" value="Port 4"/>
Policy Filter	Any <input type="button" value="v"/>
Frame Type	Any <input type="button" value="v"/>

Action	Permit <input type="button" value="v"/>
Rate Limiter	Disabled <input type="button" value="v"/>
Mirror	Disabled <input type="button" value="v"/>
Logging	Disabled <input type="button" value="v"/>
Shutdown	Disabled <input type="button" value="v"/>
Counter	0

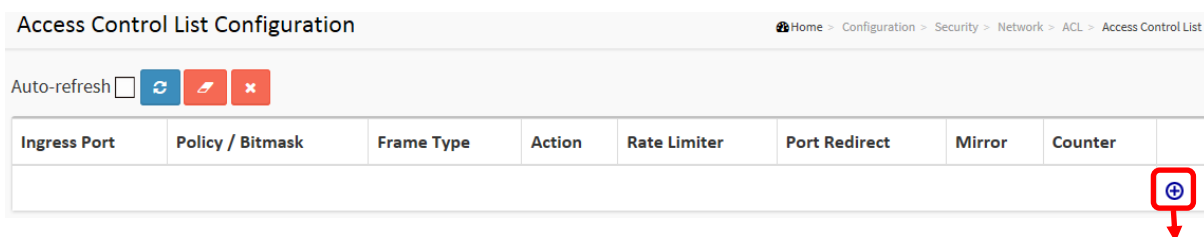
VLAN Parameters	
802.1Q Tagged	Any <input type="button" value="v"/>
VLAN ID Filter	Any <input type="button" value="v"/>
Tag Priority	Any <input type="button" value="v"/>

Parameter description:

- **Ingress Port :**

Indicates the ingress port of the ACE. Possible values are:

Any: The ACE will match any ingress port.

Policy: The ACE will match ingress ports with a specific policy.

Port: The ACE will match a specific ingress port.

- **Policy / Bitmask :**

Indicates the policy number and bitmask of the ACE.

- **Frame Type :**

Indicates the frame type of the ACE. Possible values are:

Any: The ACE will match any frame type.

EType: The ACE will match Ethernet Type frames. Note that an Ethernet Type based ACE will not get matched by IP and ARP frames.

ARP: The ACE will match ARP/RARP frames.

IPv4: The ACE will match all IPv4 frames.

IPv4/ICMP: The ACE will match IPv4 frames with ICMP protocol.

IPv4/UDP: The ACE will match IPv4 frames with UDP protocol.

IPv4/TCP: The ACE will match IPv4 frames with TCP protocol.

IPv4/Other: The ACE will match IPv4 frames, which are not ICMP/UDP/TCP.

IPv6: The ACE will match all IPv6 standard frames.

- **Action :**

Indicates the forwarding action of the ACE.

Permit: Frames matching the ACE may be forwarded and learned.

Deny: Frames matching the ACE are dropped.

Filter: Frames matching the ACE are filtered.

- **Rate Limiter :**

Indicates the rate limiter number of the ACE. The allowed range is 1 to 16. When

Disabled is displayed, the rate limiter operation is disabled.

- **Port Copy :**

Indicates the port copy operation of the ACE. Frames matching the ACE are copied to the port number. The allowed values are Disabled or a specific port number. When Disabled is displayed, the port copy operation is disabled.

- **Mirror :**

Specify the mirror operation of this port. The allowed values are:

Enabled: Frames received on the port are mirrored.

Disabled: Frames received on the port are not mirrored.

The default value is "Disabled".

- **Logging :**

Indicates the logging operation of the ACE. Possible values are:

Enabled: Frames matching the ACE are stored in the System Log.

Disabled: Frames matching the ACE are not logged.

Please note that the System Log memory size and logging rate is limited.

- **Shutdown :**

Indicates the port shut down operation of the ACE. Possible values are:

Enabled: If a frame matches the ACE, the ingress port will be disabled.

Disabled: Port shut down is disabled for the ACE.

- **Counter :**

The counter indicates the number of times the ACE was hit by a frame.

Modification Buttons

You can modify each ACE (Access Control Entry) in the table using the following buttons:

: Inserts a new ACE before the current row.

: Edits the ACE row.

: Moves the ACE up the list.

: Moves the ACE down the list.

: Deletes the ACE.

: The lowest plus sign adds a new entry at the bottom of the ACE listings.

MAC Parameter:

- **SMAC Filter**

(Only displayed when the frame type is Ethernet Type or ARP.)

Specify the source MAC filter for this ACE.

Any: No SMAC filter is specified. (SMAC filter status is "don't-care".)

Specific: If you want to filter a specific source MAC address with this ACE, choose this value. A field for entering an SMAC value appears.

- **SMAC Value**

When "Specific" is selected for the SMAC filter, you can enter a specific source MAC address. The legal format is "xx-xx-xx-xx-xx-xx" or "xx.xx.xx.xx.xx.xx" or "xxxxxxxxxxxx" (x is a hexadecimal digit). A frame that hits this ACE matches

this SMAC value.

- **DMAC Filter**

Specify the destination MAC filter for this ACE.

Any: No DMAC filter is specified. (DMAC filter status is "don't-care".)

MC: Frame must be multicast.

BC: Frame must be broadcast.

UC: Frame must be unicast.

Specific: If you want to filter a specific destination MAC address with this ACE, choose this value. A field for entering a DMAC value appears.

- **DMAC Value**

When "Specific" is selected for the DMAC filter, you can enter a specific destination MAC address. The legal format is "xx-xx-xx-xx-xx-xx" or "xx.xx.xx.xx.xx.xx" or "xxxxxxxxxxxx" (x is a hexadecimal digit). A frame that hits this ACE matches this DMAC value.

- **Buttons**

Apply – Click to save changes.

Reset- Click to undo any changes made locally and revert to previously saved values.

- **Auto-refresh:**

To evoke the auto-refresh to refresh the information automatically.

- **Upper right icon (Refresh, clear, Remove All)**

You can click them for refresh the ACL configuration or clear them by manual. Others remove all to clean up all ACL configurations on the table.

3-5.2.4 IP Source Guard

The section describes to configure the IP Source Guard detail parameters of the switch. You could use the IP Source Guard configure to enable or disable with the Port of the switch.

2-5.2.4.1 Configuration

This section describes how to configure IP Source Guard setting including :

Mode (Enabled and Disabled)

Maximum Dynamic Clients (0, 1, 2, Unlimited)

Web Interface

To configure an IP Source Guard Configuration in the web interface:

1. Select “Enabled” in the Mode of IP Source Guard Configuration.
2. Select “Enabled” of the specific port in the Mode of Port Mode Configuration.
3. Select Maximum Dynamic Clients (0, 1, 2, Unlimited) of the specific port in the Mode of Port Mode Configuration.
4. Click Apply.

Figure 3-5.2.4. 1: The IP Source Guard Configuration

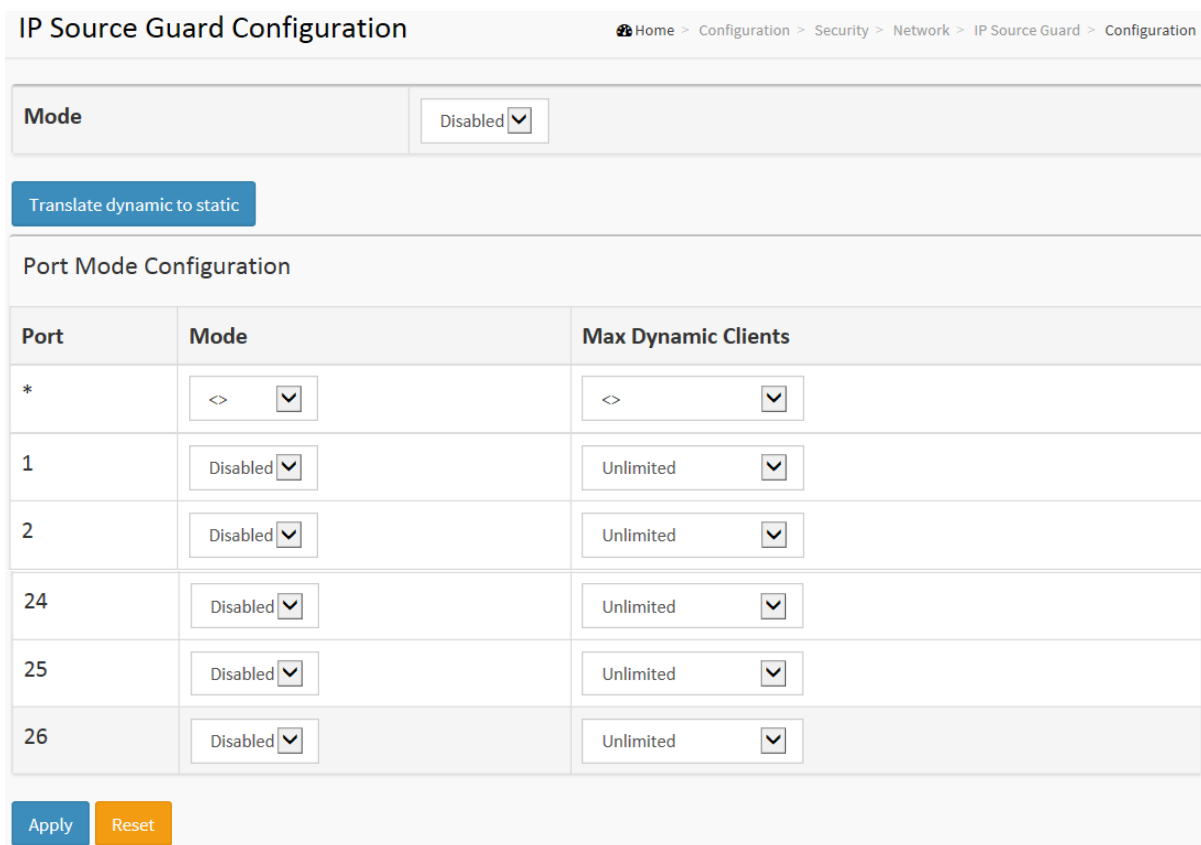

IP Source Guard Configuration Home > Configuration > Security > Network > IP Source Guard > Configuration

Mode: Disabled

[Translate dynamic to static](#)

Port Mode Configuration

Port	Mode	Max Dynamic Clients
*	<>	<>
1	Disabled	Unlimited
2	Disabled	Unlimited
24	Disabled	Unlimited
25	Disabled	Unlimited
26	Disabled	Unlimited

[Apply](#) [Reset](#)

Parameter description:

- **Mode of IP Source Guard Configuration :**

Enable the Global IP Source Guard or disable the Global IP Source Guard. All configured ACEs will be lost when the mode is enabled.

- **Port Mode Configuration :**

Specify IP Source Guard is enabled on which ports. Only when both Global Mode and Port Mode on a given port are enabled, IP Source Guard is enabled on this given port.

- **Max Dynamic Clients :**

Specify the maximum number of dynamic clients that can be learned on given port. This value can be 0, 1, 2 or unlimited. If the port mode is enabled and the value of max dynamic client is equal to 0, it means only allow the IP packets forwarding that are matched in static entries on the specific port.

2-5.2.4.2 Static Table

The section describes to configure the Static IP Source Guard Table parameters of the switch. You could use the Static IP Source Guard Table configure to manage the entries.

Web Interface

To configure a Static IP Source Guard Table Configuration in the web interface:

1. Click "Add new entry".
2. Specify the Port, VLAN ID, IP Address, and MAC address in the entry.
3. Click Apply.

Figure 3-4.2.5.2: The Static IP Source Guard Table

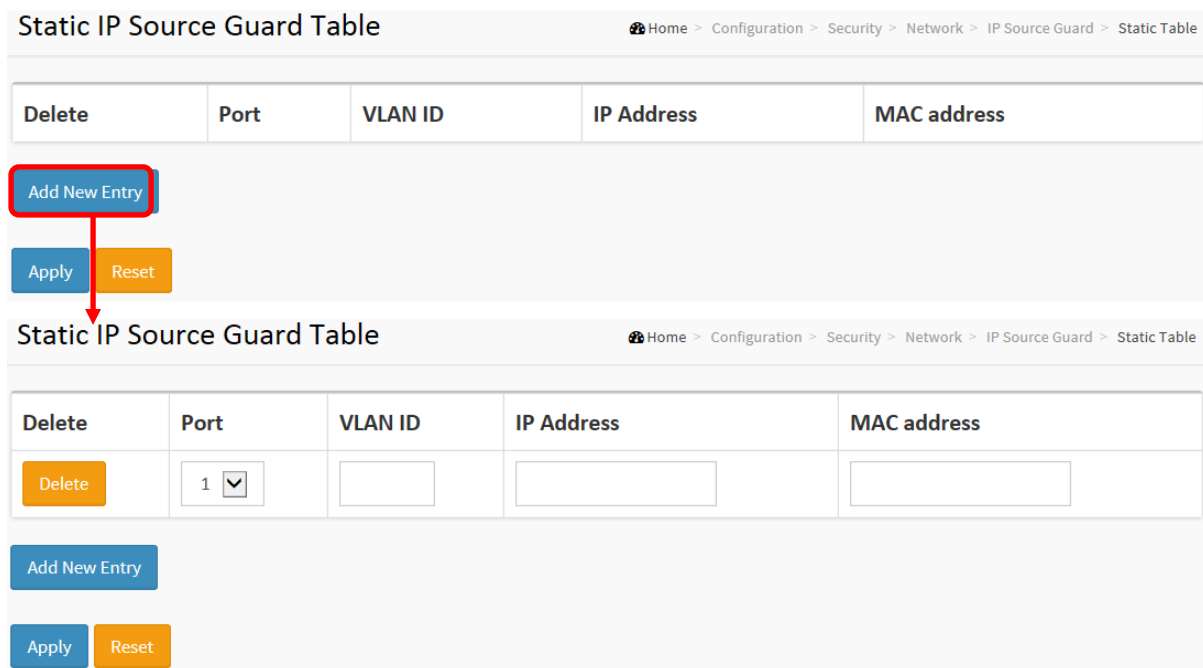

The figure shows two screenshots of the web interface for the Static IP Source Guard Table. The top screenshot shows the 'Add New Entry' button highlighted with a red box and an arrow pointing to the 'Apply' button. The bottom screenshot shows the table with one entry and the 'Add New Entry' button.

Delete	Port	VLAN ID	IP Address	MAC address
<input type="checkbox"/>				

Buttons: Add New Entry, Apply, Reset

Delete	Port	VLAN ID	IP Address	MAC address
<input type="checkbox"/>	1			

Buttons: Add New Entry, Apply, Reset

Parameter description:

- **Delete :**
Check to delete the entry. It will be deleted during the next save.
- **Port :**
The logical port for the settings.
- **VLAN ID :**
The vlan id for the settings.
- **IP Address :**
Allowed Source IP address.
- **MAC address :**
Allowed Source MAC address.
- **Adding new entry :**
Click to add a new entry to the Static IP Source Guard table. Specify the Port, VLAN ID, IP address, and IP Mask for the new entry. Click "Save".
- **Buttons:**
 - Apply** – Click to save changes.
 - Reset**- Click to undo any changes made locally and revert to previously saved values.

3-5.2.5 ARP Inspection

The section describes to configure the ARP Inspection parameters of the switch. You could use the ARP Inspection configure to manage the ARP table.

3-5.2.5.1 Configuration

This section describes how to configure ARP Inspection setting including :

Mode (Enabled and Disabled)

Port (Enabled and Disabled)

Web Interface

To configure an ARP Inspection Configuration in the web interface:

1. Select "Enabled" in the Mode of ARP Inspection Configuration.
2. Select "Enabled" of the specific port in the Mode of Port Mode Configuration.
3. Click Apply.

Figure 3-4.2.6.1: The ARP Inspection Configuration

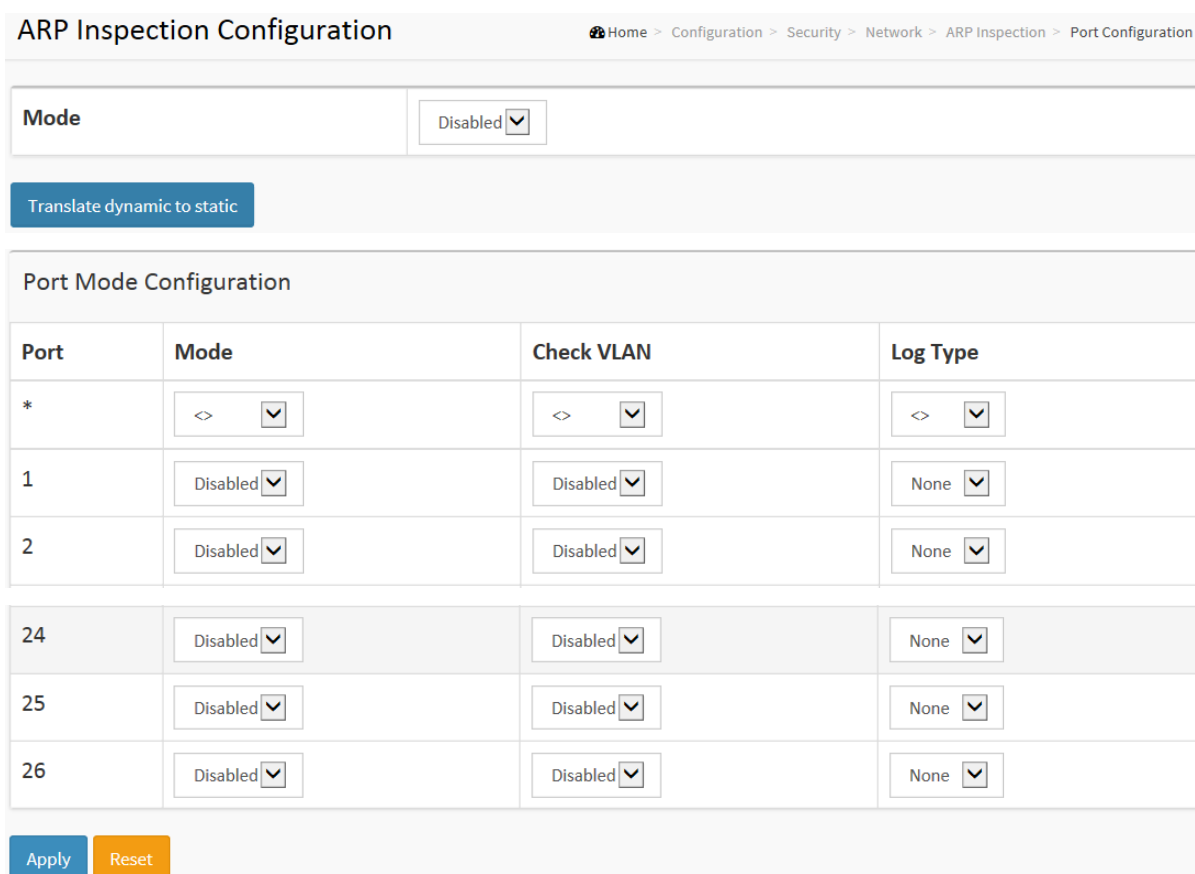

ARP Inspection Configuration Home > Configuration > Security > Network > ARP Inspection > Port Configuration

Mode: Disabled

Translate dynamic to static

Port	Mode	Check VLAN	Log Type
*	<>	<>	<>
1	Disabled	Disabled	None
2	Disabled	Disabled	None
24	Disabled	Disabled	None
25	Disabled	Disabled	None
26	Disabled	Disabled	None

Apply Reset

Parameter description:

- **Mode of ARP Inspection Configuration :**

Enable the Global ARP Inspection or disable the Global ARP Inspection.

- **Port Mode Configuration :**

Specify ARP Inspection is enabled on which ports. Only when both Global Mode and Port Mode on a given port are enabled, ARP Inspection is enabled on this given port. Possible modes are:

Enabled: Enable ARP Inspection operation.

Disabled: Disable ARP Inspection operation.

If you want to inspect the VLAN configuration, you have to enable the setting of "Check

VLAN". The default setting of "Check VLAN" is disabled. When the setting of "Check VLAN" is disabled, the log type of ARP Inspection will refer to the port setting. And the setting of "Check VLAN" is enabled, the log type of ARP Inspection will refer to the VLAN setting.

Possible setting of "Check VLAN" are:

Enabled: Enable check VLAN operation.

Disabled: Disable check VLAN operation.

Only the Global Mode and Port Mode on a given port are enabled, and the setting of "Check VLAN" is disabled, the log type of ARP Inspection will refer to the port setting. There are four log types and possible types are:

None: Log nothing.

Deny: Log denied entries.

Permit: Log permitted entries.

ALL: Log all entries.

- **Buttons:**

Apply – Click to save changes.

Reset- Click to undo any changes made locally and revert to previously saved values.

3-5.2.5.2 Navigating the VLAN Configuration

Each page shows up to 9999 entries from the VLAN table, default being 20, selected through the "entries per page" input field. When first visited, the web page will show the first 20 entries from the beginning of the VLAN Table. The first displayed will be the one with the lowest VLAN ID found in the VLAN Table.

The "VLAN" input fields allow the user to select the starting point in the VLAN Table. Clicking the button will update the displayed table starting from that or the closest next VLAN Table match. The will use the next entry of the currently displayed VLAN entry as a basis for the next lookup. When the end is reached the warning message is shown in the displayed table. Use the button to start over.

Web Interface

To configure a VLAN Mode Configuration in the web interface:

1. Click "Add new entry".
2. Specify the VLAN ID, Log Type
3. Click Apply.

Figure 3-4.2.6.2: The VLAN Mode Configuration

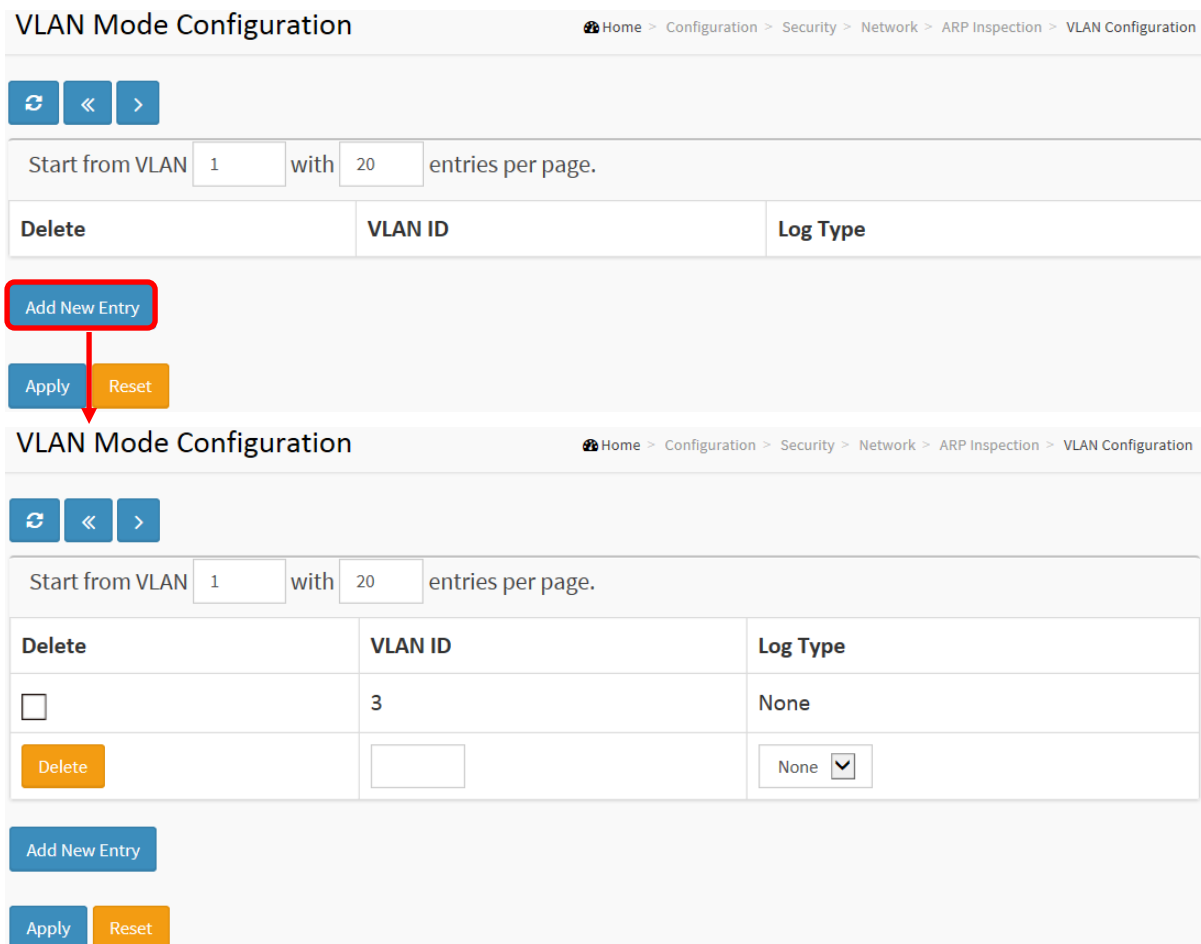

Parameter description:

- **VLAN Mode Configuration**

Specify ARP Inspection is enabled on which VLANs. First, you have to enable the port setting on Port mode configuration web page. Only when both Global Mode and Port Mode on a given port are enabled, ARP Inspection is enabled on this given port. Second, you can specify which VLAN will be inspected on VLAN mode configuration web page. The log type also can be configured on per VLAN setting.

Possible types are:

None: Log nothing.

Deny: Log denied entries.

Permit: Log permitted entries.

ALL: Log all entries.

- **Buttons**

Add New Entry: Click to add a new VLAN to the ARP Inspection VLAN table.

Apply: Click to save changes.

Reset: Click to undo any changes made locally and revert to previously saved values.

3-5.2.5.3 Static Table

The section describes to configure the Static ARP Inspection Table parameters of the switch. You could use the Static ARP Inspection Table configure to manage the ARP entries.

Web Interface

To configure a Static ARP Inspection Table Configuration in the web interface:

1. Click "Add new entry".
2. Specify the Port, VLAN ID, IP Address, and MAC address in the entry.
3. Click Apply.

Figure 3-4.2.6.3: The Static ARP Inspection Table

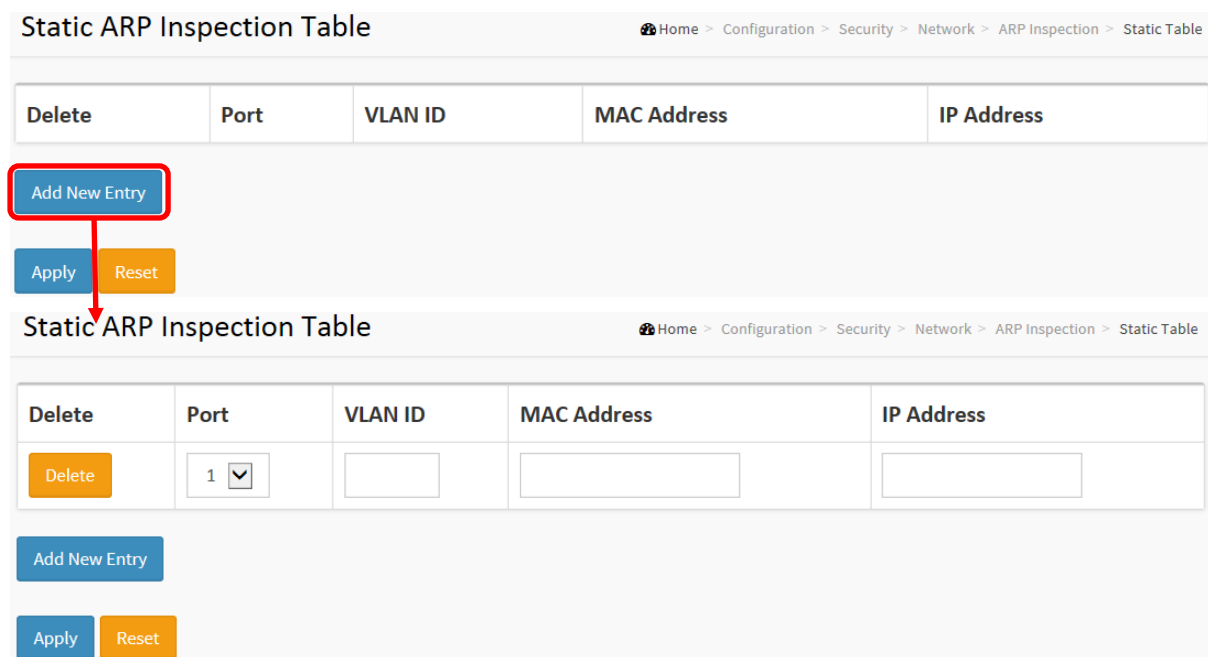

The screenshot shows the 'Static ARP Inspection Table' configuration page in two states. The top state shows an empty table with columns: Delete, Port, VLAN ID, MAC Address, and IP Address. Below the table are buttons for 'Add New Entry', 'Apply', and 'Reset'. A red box highlights the 'Add New Entry' button, with a red arrow pointing down to the bottom state. The bottom state shows the same table, but the 'Delete' column now has a 'Delete' button, the 'Port' column has a dropdown menu with '1' selected, and the 'VLAN ID', 'MAC Address', and 'IP Address' columns have empty input fields. The 'Add New Entry', 'Apply', and 'Reset' buttons are still present below the table.

Parameter description:

- **Delete :**
Check to delete the entry. It will be deleted during the next save.
- **Port :**
The logical port for the settings.
- **VLAN ID :**
The vlan id for the settings.
- **MAC Address :**
Allowed Source MAC address in ARP request packets.
- **IP Address :**
Allowed Source IP address in ARP request packets.
- **Adding new entry :**
Click to add a new entry to the Static ARP Inspection table. Specify the Port, VLAN ID, MAC address, and IP address for the new entry. Click "Save".
- **Buttons:**
 - Apply** – Click to save changes.
 - Reset**- Click to undo any changes made locally and revert to previously saved

values.

3-5.2.5.4 Dynamic Table

Entries in the Dynamic ARP Inspection Table are shown on this page. The Dynamic ARP Inspection Table contains up to 1024 entries, and is sorted first by port, then by VLAN ID, then by MAC address, and then by IP address.

Navigating the ARP Inspection Table

Each page shows up to 99 entries from the Dynamic ARP Inspection table, default being 20, selected through the "entries per page" input field. When first visited, the web page will show the first 20 entries from the beginning of the Dynamic ARP Inspection Table.

The "Start from port address", "VLAN", "MAC address" and "IP address" input fields allow the user to select the starting point in the Dynamic ARP Inspection Table. Clicking the button will update the displayed table starting from that or the closest next Dynamic ARP Inspection Table match. In addition, the two input fields will - upon a button click - assume the value of the first displayed entry, allowing for continuous refresh with the same start address.

The will use the last entry of the currently displayed table as a basis for the next lookup. When the end is reached the text "No more entries" is shown in the displayed table. Use the button to start over.

Web Interface

To configure a Dynamic ARP Inspection Table Configuration in the web interface:

Figure 3-5.2.5.4: The Dynamic ARP Inspection Table

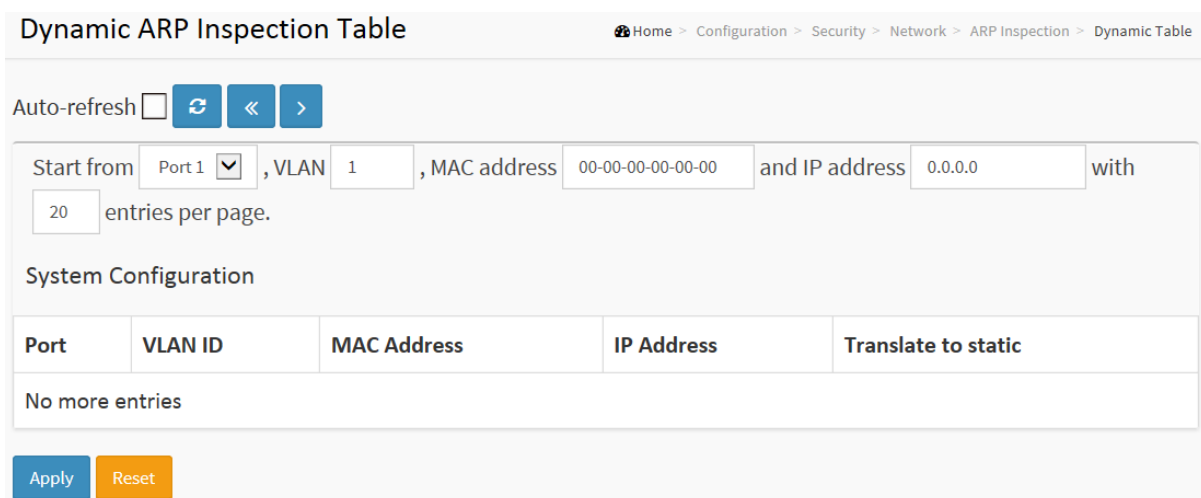

Dynamic ARP Inspection Table Home > Configuration > Security > Network > ARP Inspection > Dynamic Table

Auto-refresh ↻ ⏪ ⏩

Start from , VLAN , MAC address and IP address with entries per page.

System Configuration

Port	VLAN ID	MAC Address	IP Address	Translate to static
No more entries				

Parameter description:

ARP Inspection Table Columns

- **Port**
Switch Port Number for which the entries are displayed.
- **VLAN ID**
VLAN-ID in which the ARP traffic is permitted.
- **MAC Address**
User MAC address of the entry.
- **IP Address**
User IP address of the entry.
- **Translate to static**

Select the checkbox to translate the entry to static entry.

- **Buttons:**

Apply – Click to save changes.

Reset- Click to undo any changes made locally and revert to previously saved values.

Auto-refresh:

Check this box to refresh the page automatically. Automatic refresh occurs every 3 seconds.

Refresh:

Refreshes the displayed table starting from the input fields.

Save:

Click to save changes.

Reset:

Click to undo any changes made locally and revert to previously saved values.

<<:

Updates the table starting from the first entry in the Dynamic ARP Inspection Table.

>>:

Updates the table, starting with the entry after the last entry currently displayed

3-5.3 AAA

This section shows you to use an AAA (Authentication, Authorization, Accounting) server to provide access control to your network. The AAA server can be a TACACS+ or RADIUS server to create and manage objects that contain settings for using AAA servers.

3-5.3.1 RADIUS

Web Interface

To configure a Common Configuration of AAA, RADIUS in the web interface:

Figure 3-4.3.2: The RADIUS Authentication Server Configuration

RADIUS Server Configuration Home > Configuration > Security > AAA > RADIUS

Global Configuration

Timeout	<input type="text" value="5"/> seconds
Retransmit	<input type="text" value="3"/> times
Deadtime	<input type="text" value="0"/> minutes
Key	<input type="text"/>
NAS-IP-Address	<input type="text"/>
NAS-IPv6-Address	<input type="text"/>
NAS-Identifier	<input type="text"/>

Server Configuration

Delete	Hostname	Auth Port	Acct Port	Timeout	Retransmit	Key
Add New Server						
Apply	Reset					

Server Configuration

Delete	Hostname	Auth Port	Acct Port	Timeout	Retransmit	Key
Delete	<input type="text"/>	<input type="text" value="1812"/>	<input type="text" value="1813"/>	<input type="text"/>	<input type="text"/>	<input type="text"/>

< >

[Add New Server](#)

[Apply](#) [Reset](#)

Parameter description:

Global Configuration

These setting are common for all of the RADIUS servers.

- **Timeout**

Timeout is the number of seconds, in the range 1 to 1000, to wait for a reply from a RADIUS

server before retransmitting the request.

- **Retransmit**

Retransmit is the number of times, in the range 1 to 1000, a RADIUS request is retransmitted to a server that is not responding. If the server has not responded after the last retransmit it is considered to be dead.

- **Deadtime**

Deadtime, which can be set to a number between 0 to 1440 minutes, is the period during which the switch will not send new requests to a server that has failed to respond to a previous request. This will stop the switch from continually trying to contact a server that it has already determined as dead.

Setting the Deadtime to a value greater than 0 (zero) will enable this feature, but only if more than one server has been configured.

- **Key**

The secret key - up to 63 characters long - shared between the RADIUS server and the switch.

- **NAS-IP-Address (Attribute 4)**

The IPv4 address to be used as attribute 4 in RADIUS Access-Request packets. If this field is left blank, the IP address of the outgoing interface is used.

- **NAS-IPv6-Address (Attribute 95)**

The IPv6 address to be used as attribute 95 in RADIUS Access-Request packets. If this field is left blank, the IP address of the outgoing interface is used.

- **NAS-Identifier (Attribute 32)**

The identifier - up to 255 characters long - to be used as attribute 32 in RADIUS Access-Request packets. If this field is left blank, the NAS-Identifier is not included in the packet.

Server Configuration

The table has one row for each RADIUS server and a number of columns, which are:

- **Delete**

To delete a RADIUS server entry, check this box. The entry will be deleted during the next Save.

- **Hostname**

The IP address or hostname of the RADIUS server.

- **Auth Port**

The UDP port to use on the RADIUS server for authentication.

- **Acct Port**

The UDP port to use on the RADIUS server for accounting.

- **Timeout**

This optional setting overrides the global timeout value. Leaving it blank will use the global timeout value.

- **Retransmit**

This optional setting overrides the global retransmit value. Leaving it blank will use the global retransmit value.

- **Key**

This optional setting overrides the global key. Leaving it blank will use the global key.

Adding a New Server

Click to add a new RADIUS server. An empty row is added to the table, and the RADIUS server can be configured as needed. Up to 5 servers are supported. The button can be used to undo the addition of the new server.

Buttons

- **Apply:**

Click to save changes.

- **Reset:**

Click to undo any changes made locally and revert to previously saved values.

3-6 Aggregation

The Aggregation is used to configure the settings of Link Aggregation. You can bundle more than one port with the same speed, full duplex and the same MAC to be a single logical port, thus the logical port aggregates the bandwidth of these ports. This means you can apply your current Ethernet equipment's to build the bandwidth aggregation. For example, if there are three Fast Ethernet ports aggregated in a logical port, then this logical port has bandwidth three times as high as a single Fast Ethernet port has.

3-6.1 Static

Ports using Static Trunk as their trunk method can choose their unique Static GroupID to form a logic "trunked port". The benefit of using Static Trunk method is that a port can immediately become a member of a trunk group without any handshaking with its peer port. This is also a disadvantage because the peer ports of your static trunk group may not know that they should be aggregate together to form a "logic trunked port". Using Static Trunk on both end of a link is strongly recommended. Please also note that low speed links will stay in "not ready" state when using static trunk to aggregate with high speed links.

Web Interface

To configure the Trunk Aggregation Hash mode and Aggregation Group in the web interface:

1. Click Configuration, Aggregation, Static and then Aggregation Mode Configuration.
2. Evoke to enable or disable the aggregation mode function.
Evoke Aggregation Group ID and Port members
3. Click the save to save the setting
4. If you want to cancel the setting then you need to click the reset button. It will revert to previously saved values.

Figure 3-6.1: The Aggregation Mode Configuration

Aggregation Mode Configuration
Home > Configuration > Aggregation > Static

Hash Code Contributors

Source MAC Address	<input checked="" type="checkbox"/>
Destination MAC Address	<input type="checkbox"/>
IP Address	<input checked="" type="checkbox"/>
TCP/UDP Port Number	<input checked="" type="checkbox"/>

Aggregation Group Configuration

Group ID	Port Members																									
	1	2	3	4	5	6	7	8	9	10	11	12	13	14	15	16	17	18	19	20	21	22	23	24	25	26
Normal	<input checked="" type="checkbox"/>	<input checked="" type="checkbox"/>	<input checked="" type="checkbox"/>	<input checked="" type="checkbox"/>	<input checked="" type="checkbox"/>	<input checked="" type="checkbox"/>	<input checked="" type="checkbox"/>	<input checked="" type="checkbox"/>	<input checked="" type="checkbox"/>	<input checked="" type="checkbox"/>	<input checked="" type="checkbox"/>	<input checked="" type="checkbox"/>	<input checked="" type="checkbox"/>	<input checked="" type="checkbox"/>	<input checked="" type="checkbox"/>	<input checked="" type="checkbox"/>	<input checked="" type="checkbox"/>	<input checked="" type="checkbox"/>	<input checked="" type="checkbox"/>	<input checked="" type="checkbox"/>	<input checked="" type="checkbox"/>	<input checked="" type="checkbox"/>	<input checked="" type="checkbox"/>	<input checked="" type="checkbox"/>	<input checked="" type="checkbox"/>	<input checked="" type="checkbox"/>
1	<input type="checkbox"/>	<input type="checkbox"/>	<input type="checkbox"/>	<input type="checkbox"/>	<input type="checkbox"/>	<input type="checkbox"/>	<input type="checkbox"/>	<input type="checkbox"/>	<input type="checkbox"/>	<input type="checkbox"/>	<input type="checkbox"/>	<input type="checkbox"/>	<input type="checkbox"/>	<input type="checkbox"/>	<input type="checkbox"/>	<input type="checkbox"/>	<input type="checkbox"/>	<input type="checkbox"/>	<input type="checkbox"/>	<input type="checkbox"/>	<input type="checkbox"/>	<input type="checkbox"/>	<input type="checkbox"/>	<input type="checkbox"/>	<input type="checkbox"/>	<input type="checkbox"/>
2	<input type="checkbox"/>	<input type="checkbox"/>	<input type="checkbox"/>	<input type="checkbox"/>	<input type="checkbox"/>	<input type="checkbox"/>	<input type="checkbox"/>	<input type="checkbox"/>	<input type="checkbox"/>	<input type="checkbox"/>	<input type="checkbox"/>	<input type="checkbox"/>	<input type="checkbox"/>	<input type="checkbox"/>	<input type="checkbox"/>	<input type="checkbox"/>	<input type="checkbox"/>	<input type="checkbox"/>	<input type="checkbox"/>	<input type="checkbox"/>	<input type="checkbox"/>	<input type="checkbox"/>	<input type="checkbox"/>	<input type="checkbox"/>	<input type="checkbox"/>	<input type="checkbox"/>

11	<input type="checkbox"/>	<input type="checkbox"/>	<input type="checkbox"/>	<input type="checkbox"/>	<input type="checkbox"/>	<input type="checkbox"/>	<input type="checkbox"/>	<input type="checkbox"/>	<input type="checkbox"/>	<input type="checkbox"/>	<input type="checkbox"/>	<input type="checkbox"/>	<input type="checkbox"/>	<input type="checkbox"/>	<input type="checkbox"/>	<input type="checkbox"/>	<input type="checkbox"/>	<input type="checkbox"/>	<input type="checkbox"/>	<input type="checkbox"/>	<input type="checkbox"/>	<input type="checkbox"/>	<input type="checkbox"/>	<input type="checkbox"/>	<input type="checkbox"/>
12	<input type="checkbox"/>	<input type="checkbox"/>	<input type="checkbox"/>	<input type="checkbox"/>	<input type="checkbox"/>	<input type="checkbox"/>	<input type="checkbox"/>	<input type="checkbox"/>	<input type="checkbox"/>	<input type="checkbox"/>	<input type="checkbox"/>	<input type="checkbox"/>	<input type="checkbox"/>	<input type="checkbox"/>	<input type="checkbox"/>	<input type="checkbox"/>	<input type="checkbox"/>	<input type="checkbox"/>	<input type="checkbox"/>	<input type="checkbox"/>	<input type="checkbox"/>	<input type="checkbox"/>	<input type="checkbox"/>	<input type="checkbox"/>	<input type="checkbox"/>
13	<input type="checkbox"/>	<input type="checkbox"/>	<input type="checkbox"/>	<input type="checkbox"/>	<input type="checkbox"/>	<input type="checkbox"/>	<input type="checkbox"/>	<input type="checkbox"/>	<input type="checkbox"/>	<input type="checkbox"/>	<input type="checkbox"/>	<input type="checkbox"/>	<input type="checkbox"/>	<input type="checkbox"/>	<input type="checkbox"/>	<input type="checkbox"/>	<input type="checkbox"/>	<input type="checkbox"/>	<input type="checkbox"/>	<input type="checkbox"/>	<input type="checkbox"/>	<input type="checkbox"/>	<input type="checkbox"/>	<input type="checkbox"/>	<input type="checkbox"/>

Parameter description:

Hash Code Contributors

- **Source MAC Address :**
The Source MAC address can be used to calculate the destination port for the frame. Check to enable the use of the Source MAC address, or uncheck to disable. By default, Source MAC Address is enabled.
- **Destination MAC Address :**
The Destination MAC Address can be used to calculate the destination port for the frame. Check to enable the use of the Destination MAC Address, or uncheck to disable. By default, Destination MAC Address is disabled.
- **IP Address :**
The IP address can be used to calculate the destination port for the frame. Check to enable the use of the IP Address, or uncheck to disable. By default, IP Address is enabled.
- **TCP/UDP Port Number :**
The TCP/UDP port number can be used to calculate the destination port for the frame. Check to enable the use of the TCP/UDP Port Number, or uncheck to disable. By default, TCP/UDP Port Number is enabled.

Aggregation Group Configuration

- **Group ID :**
Indicates the group ID for the settings contained in the same row. Group ID "Normal" indicates there is no aggregation. Only one group ID is valid per port.
- **Port Members :**
Each switch port is listed for each group ID. Select a radio button to include a port in an aggregation, or clear the radio button to remove the port from the aggregation. By default, no ports belong to any aggregation group. Only full duplex ports can join an aggregation and ports must be in the same speed in each group.
- **Buttons**
 - Apply** – Click to save changes.
 - Reset**- Click to undo any changes made locally and revert to previously saved values.

3-6.2 LACP

This page allows the user to inspect the current LACP port configurations, and possibly change them as well. An LACP trunk group with more than one ready member-ports is a “real trunked” group. An LACP trunk group with only one or less than one ready member-ports is not a “real trunked” group.

Web Interface

To configure the Trunk Aggregation LACP parameters in the web interface:

1. Click Configuration, LACP, Configuration
2. Evoke to enable or disable the LACP on the port of the switch.
Scroll the Key parameter with Auto or Specific Default is Auto.
3. Scroll the Role with Active or Passive. Default is Active
4. Click the save to save the setting
5. If you want to cancel the setting then you need to click the reset button.
It will revert to previously saved values

Figure 3-5.2: The LACP Port Configuration

LACP Port Configuration Home > Configuration > Aggregation > LACP

Port	LACP Enabled	Key	Role	Timeout	Prio
*	<input type="checkbox"/>	<> ▼	<> ▼	<> ▼	32768
1	<input type="checkbox"/>	Auto ▼	Active ▼	Fast ▼	32768
2	<input type="checkbox"/>	Auto ▼	Active ▼	Fast ▼	32768
3	<input type="checkbox"/>	Auto ▼	Active ▼	Fast ▼	32768
23	<input type="checkbox"/>	Auto ▼	Active ▼	Fast ▼	32768
24	<input type="checkbox"/>	Auto ▼	Active ▼	Fast ▼	32768
25	<input type="checkbox"/>	Auto ▼	Active ▼	Fast ▼	32768
26	<input type="checkbox"/>	Auto ▼	Active ▼	Fast ▼	32768

Apply Reset

Parameter description:

- **Port :**

The switch port number.

- **LACP Enabled**

Controls whether LACP is enabled on this switch port. LACP will form an aggregation when 2 or more ports are connected to the same partner.

- **Key**

The Key value incurred by the port, range 1-65535 . The Auto setting will set the key as appropriate by the physical link speed, 10Mb = 1, 100Mb = 2, 1Gb = 3. Using the Specific setting, a user-defined value can be entered. Ports with the same Key value can participate in the same aggregation group, while ports with different keys cannot.

- **Role**

The Role shows the LACP activity status. The Active will transmit LACP packets each second, while Passive will wait for a LACP packet from a partner (speak if spoken to).

- **Timeout**

The Timeout controls the period between BPDU transmissions. Fast will transmit LACP packets each second, while Slow will wait for 30 seconds before sending a LACP packet.

- **Prio**

The Prio controls the priority of the port. If the LACP partner wants to form a larger group than is supported by this device then this parameter will control which ports will be active and which ports will be in a backup role. Lower number means greater priority.

- **Buttons**

Apply – Click to save changes.

Reset- Click to undo any changes made locally and revert to previously saved values.

3-7 Loop Protection

The loop Protection is used to detect the presence of traffic. When switch receives packet's (looping detection frame) MAC address the same as oneself from port, show Loop Protection happens. The port will be locked when it received the looping Protection frames. If you want to resume the locked port, please find out the looping path and take off the looping path, then select the resume the locked port and click on "Resume" to turn on the locked ports.

Web Interface

To configure the Loop Protection parameters in the web interface:

1. Click Configuration, Loop Protection.
2. Evoke to select enable or disable the port loop Protection
3. Click the save to save the setting
4. If you want to cancel the setting then you need to click the Reset button. It will revert to previously saved values

Figure 3-7: The Loop Protection Configuration.

Loop Protection Configuration
Home > Configuration > Loop Protection

Global Configuration

Enable Loop Protection	Disable <input type="button" value="v"/>
Transmission Time	<input style="width: 80%;" type="text" value="5"/> seconds
Shutdown Time	<input style="width: 80%;" type="text" value="180"/> seconds

Port Configuration

Port	Enable	Action	Tx Mode
*	<input checked="" type="checkbox"/>	<> <input type="button" value="v"/>	<> <input type="button" value="v"/>
1	<input checked="" type="checkbox"/>	Shutdown Port <input type="button" value="v"/>	Enable <input type="button" value="v"/>
2	<input checked="" type="checkbox"/>	Shutdown Port <input type="button" value="v"/>	Enable <input type="button" value="v"/>
24	<input checked="" type="checkbox"/>	Shutdown Port <input type="button" value="v"/>	Enable <input type="button" value="v"/>
25	<input checked="" type="checkbox"/>	Shutdown Port <input type="button" value="v"/>	Enable <input type="button" value="v"/>
26	<input checked="" type="checkbox"/>	Shutdown Port <input type="button" value="v"/>	Enable <input type="button" value="v"/>

Parameter description:

- **Enable Loop Protection:**

Controls whether loop protections is enabled (as a whole).

- **Transmission Time:**

The interval between each loop protection PDU sent on each port. valid values are 1 to 10 seconds.

- **Shutdown Time:**

The period (in seconds) for which a port will be kept disabled in the event of a loop is detected (and the port action shuts down the port). Valid values are 0 to 604800 seconds (7 days). A value of zero will keep a port disabled (until next device restart).

- **Port No:**

The switch port number of the port.

- **Enable :**

Controls whether loop protection is enabled on this switch port

- **Action:**

Configures the action performed when a loop is detected on a port. Valid values are Shutdown Port, Shutdown Port and Log or Log Only.

- **Tx Mode :**

Controls whether the port is actively generating loop protection PDU's, or whether it is just passively looking for looped PDU's.

- **Buttons:**

Apply – Click to save changes.

Reset- Click to undo any changes made locally and revert to previously saved values.

3-8 Spanning Tree

The Spanning Tree Protocol (STP) can be used to detect and disable network loops, and to provide backup links between switches, bridges or routers. This allows the switch to interact with other bridging devices (that is, an STP-compliant switch, bridge or router) in your network to ensure that only one route exists between any two stations on the network, and provide backup links which automatically take over when a primary link goes down.

STP - STP uses a distributed algorithm to select a bridging device (STP-compliant switch, bridge or router) that serves as the root of the spanning tree network. It selects a root port on each bridging device (except for the root device) which incurs the lowest path cost when forwarding a packet from that device to the root device. Then it selects a designated bridging device from each LAN which incurs the lowest path cost when forwarding a packet from that LAN to the root device. All ports connected to designated bridging devices are assigned as designated ports. After determining the lowest cost spanning tree, it enables all root ports and designated ports, and disables all other ports. Network packets are therefore only forwarded between root ports and designated ports, eliminating any possible network loops.

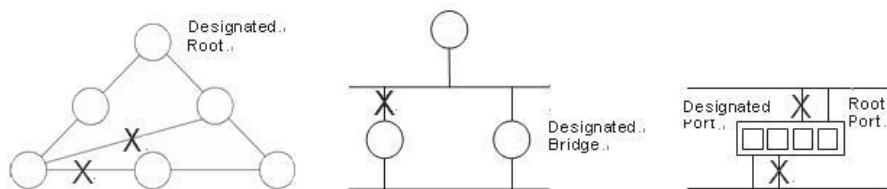

Once a stable network topology has been established, all bridges listen for Hello BPDUs (Bridge Protocol Data Units) transmitted from the Root Bridge. If a bridge does not get a Hello BPDU after a predefined interval (Maximum Age), the bridge assumes that the link to the Root Bridge is down. This bridge will then initiate negotiations with other bridges to reconfigure the network to reestablish a valid network topology.

3-8.1 Bridge Setting

The section describes that how to configure the Spanning Tree Bridge and STP System settings. It allows you to configure STP System settings are used by all STP Bridge instance in the switch.

Web Interface

To configure the Spanning Tree Bridge Settings parameters in the web interface:

1. Click Configuration, Spanning Tree, Bridge Settings
2. Scroll to select the parameters and write down available value of parameters in blank field in Basic Settings
3. Evoke to enable or disable the parameters and write down available value of parameters in blank field in Advanced settings
4. Click the apply to save the setting
5. If you want to cancel the setting then you need to click the Reset button. It will revert to previously saved values

Figure 3-8.1: The STP Bridge Configuration
STP Bridge Configuration

Basic Settings	
Protocol Version	MSTP <input type="button" value="v"/>
Bridge Priority	32768 <input type="button" value="v"/>
Forward Delay	15 <input type="text"/>
Max Age	20 <input type="text"/>
Maximum Hop Count	20 <input type="text"/>
Transmit Hold Count	6 <input type="text"/>
Advanced Settings	
Edge Port BPDU Filtering	<input type="checkbox"/>
Edge Port BPDU Guard	<input type="checkbox"/>
Port Error Recovery	<input type="checkbox"/>
Port Error Recovery Timeout	<input type="text"/>

Parameter description:

Basic Settings

- **Protocol Version :**
The STP protocol version setting. Valid values are STP, RSTP and MSTP.
- **Bridge Priority :**
Controls the bridge priority. Lower numeric values have better priority. The bridge priority plus the MSTI instance number, concatenated with the 6-byte MAC address of the switch forms a Bridge Identifier. For MSTP operation, this is the priority of the CIST. Otherwise, this is the priority of the STP/RSTP bridge.
- **Forward Delay :**
The delay used by STP Bridges to transit Root and Designated Ports to Forwarding (used in STP compatible mode). Valid values are in the range 4 to 30 seconds.
- **Max Age :**
The maximum age of the information transmitted by the Bridge when it is the Root Bridge. Valid values are in the range 6 to 40 seconds, and MaxAge must be $\leq (\text{FwdDelay}-1)*2$.
- **Maximum Hop Count :**
This defines the initial value of remaining Hops for MSTI information generated at the boundary of an MSTI region. It defines how many bridges a root bridge can distribute its BPDU information to. Valid values are in the range 6 to 40 hops.

- **Transmit Hold Count :**

The number of BPDU's a bridge port can send per second. When exceeded, transmission of the next BPDU will be delayed. Valid values are in the range 1 to 10 BPDU's per second.

Advanced Settings

- **Edge Port BPDU Filtering :**

Control whether a port explicitly configured as Edge will transmit and receive BPDUs.

- **Edge Port BPDU Guard :**

Control whether a port explicitly configured as Edge will disable itself upon reception of a BPDU. The port will enter the error-disabled state, and will be removed from the active topology.

- **Port Error Recovery :**

Control whether a port in the error-disabled state automatically will be enabled after a certain time. If recovery is not enabled, ports have to be disabled and re-enabled for normal STP operation. The condition is also cleared by a system reboot.

- **Port Error Recovery Timeout :**

The time to pass before a port in the error-disabled state can be enabled. Valid values are between 30 and 86400 seconds (24 hours).

- **Buttons**

Apply – Click to save changes.

Reset- Click to undo any changes made locally and revert to previously saved values.

3-8.2 MSTI Mapping

When you implement an Spanning Tree protocol on the switch that the bridge instance. The CIST is not available for explicit mapping, as it will receive the VLANs not explicitly mapped. Due to the reason that you need to set the list of VLANs mapped to the MSTI. The VLANs must be separated with comma and/or space. A VLAN can only be mapped to one MSTI. An unused MSTI should just be left empty. (I.e. not having any VLANs mapped to it.)

This section describes it allows the user to inspect the current STP MSTI bridge instance priority configurations, and possibly change them as well.

Web Interface

To configure the Spanning Tree MSTI Mapping parameters in the web interface:

1. Click Configuration, Spanning Tree, MSTI Mapping
2. Specify the configuration identification parameters in the field. Specify the VLANs Mapped blank field.
3. Click the save to save the setting
4. If you want to cancel the setting then you need to click the Reset button. It will revert to previously saved values

Figure 3-9.2: The MSTI Configuration

MSTI Configuration

Add VLANs separated by spaces or comma.

[Home](#) > [Configuration](#) > [Spanning Tree](#) > [MSTI Mapping](#)

Unmapped VLANs are mapped to the CIST. (The default bridge instance).

Configuration Identification

Configuration Name	<input type="text" value="00-40-c7-01-02-03"/>
Configuration Revision	<input type="text" value="0"/>

MSTI Mapping

MSTI	VLANs Mapped
MSTI1	<input type="text"/>
MSTI2	<input type="text"/>
MSTI3	<input type="text"/>
MSTI4	<input type="text"/>
MSTI5	<input type="text"/>
MSTI6	<input type="text"/>
MSTI7	<input type="text"/>

Apply
Reset

Parameter description:

Configuration Identification

- **Configuration Name :**

The name identifying the VLAN to MSTI mapping. Bridges must share the name and revision (see below), as well as the VLAN-to-MSTI mapping configuration in order to share spanning trees for MSTI's (Intra-region). The name is at most 32 characters.

- **Configuration Revision :**

The revision of the MSTI configuration named above. This must be an integer between 0 and 65535.

- **MSTI :**

The bridge instance. The CIST is not available for explicit mapping, as it will receive the VLANs not explicitly mapped.

- **VLANs Mapped :**

The list of VLANs mapped to the MSTI. The VLANs can be given as a single (xx, xx being between 1 and 4094) VLAN, or a range (xx-yy), each of which must be separated with comma and/or space. A VLAN can only be mapped to one MSTI. An unused MSTI should just be left empty. (I.e. not having any VLANs mapped to it.) Example: 2,5,20-40.

3-8.3 MSTI Priorities

When you implement a Spanning Tree protocol on the switch that the bridge instance. The CIST is the default instance which is always active. For controls the bridge priority. Lower numeric values have better priority. The bridge priority plus the MSTI instance number, concatenated with the 6-byte MAC address of the switch forms a Bridge Identifier

The section describes it allows the user to inspect the current STP MSTI bridge instance priority configurations, and possibly change them as well.

Web Interface

To configure the Spanning Tree MSTI Priorities parameters in the web interface:

1. Click Configuration, Spanning Tree, MSTI Priorities
2. Scroll the Priority maximum is 240. Default is 128.
3. Click the save to save the setting
4. If you want to cancel the setting then you need to click the Reset button. It will revert to previously saved values

Figure 3-8.3: The MSTI Configuration

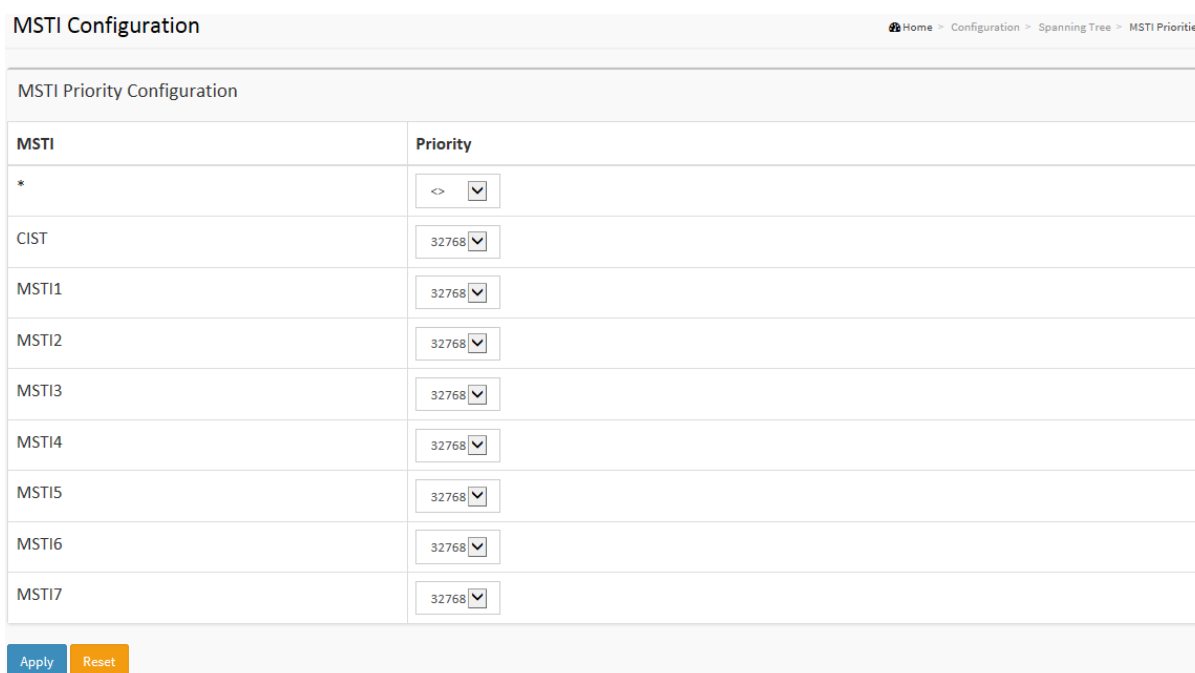

MSTI	Priority
*	<> ▼
CIST	32768 ▼
MSTI1	32768 ▼
MSTI2	32768 ▼
MSTI3	32768 ▼
MSTI4	32768 ▼
MSTI5	32768 ▼
MSTI6	32768 ▼
MSTI7	32768 ▼

Apply Reset

Parameter description:

- **MSTI :**
The bridge instance. The CIST is the default instance, which is always active.
- **Priority :**
Controls the bridge priority. Lower numeric values have better priority. The bridge priority plus the MSTI instance number, concatenated with the 6-byte MAC address of the switch forms a Bridge Identifier.
- **Buttons**
 - Apply** – Click to save changes.
 - Reset**- Click to undo any changes made locally and revert to previously saved values.

3-8.4 CIST Ports

When you implement an Spanning Tree protocol on the switch that the bridge instance. You need to configure the CIST Ports. The section describes it allows the user to inspect the to inspect the current STP CIST port configurations, and possibly change them as well.

Web Interface

To configure the Spanning Tree CIST Ports parameters in the web interface:

1. Click Configuration, Spanning Tree, CIST Ports
2. Scroll and evoke to set all parameters of CIST Aggregated Port Configuration.
3. Evoke to enable or disable the STP, then scoll and evoke to set all parameters of the CIST normal Port configuration.
4. Click the apply to save the setting
5. If you want to cancel the setting then you need to click the Reset button. It will revert to previously saved values

Figure 3-8.4: The STP CIST Port Configuration

STP CIST Port Configuration Home > Configuration > Spanning Tree > CIST Port

CIST Aggregated Port Configuration

Port	STP Enabled	Path Cost	Priority	Admin Edge	Auto Edge	Restricted		BPDU Guard	Point-to-point
						Role	TCN		
-	<input checked="" type="checkbox"/>	Auto <input type="text"/>	128 <input type="text"/>	Non-Edge <input type="text"/>	<input checked="" type="checkbox"/>	<input type="checkbox"/>	<input type="checkbox"/>	<input type="checkbox"/>	Forced True <input type="text"/>

CIST Normal Port Configuration

Port	STP Enabled	Path Cost	Priority	Admin Edge	Auto Edge	Restricted		BPDU Guard	Point-to-point
						Role	TCN		
*	<input checked="" type="checkbox"/>	<> <input type="text"/>	<> <input type="text"/>	<> <input type="text"/>	<input checked="" type="checkbox"/>	<input type="checkbox"/>	<input type="checkbox"/>	<input type="checkbox"/>	<> <input type="text"/>
1	<input checked="" type="checkbox"/>	Auto <input type="text"/>	128 <input type="text"/>	Non-Edge <input type="text"/>	<input checked="" type="checkbox"/>	<input type="checkbox"/>	<input type="checkbox"/>	<input type="checkbox"/>	Auto <input type="text"/>
2	<input checked="" type="checkbox"/>	Auto <input type="text"/>	128 <input type="text"/>	Non-Edge <input type="text"/>	<input checked="" type="checkbox"/>	<input type="checkbox"/>	<input type="checkbox"/>	<input type="checkbox"/>	Auto <input type="text"/>
25	<input checked="" type="checkbox"/>	Auto <input type="text"/>	128 <input type="text"/>	Non-Edge <input type="text"/>	<input checked="" type="checkbox"/>	<input type="checkbox"/>	<input type="checkbox"/>	<input type="checkbox"/>	Auto <input type="text"/>
26	<input checked="" type="checkbox"/>	Auto <input type="text"/>	128 <input type="text"/>	Non-Edge <input type="text"/>	<input checked="" type="checkbox"/>	<input type="checkbox"/>	<input type="checkbox"/>	<input type="checkbox"/>	Auto <input type="text"/>

Apply

Parameter description:

- **Port :**

The switch port number of the logical STP port.
- **STP Enabled :**

Controls whether STP is enabled on this switch port.
- **Path Cost :**

Controls the path cost incurred by the port. The Auto setting will set the path cost as appropriate by the physical link speed, using the 802.1D recommended values. Using the Specific setting, a user-defined value can be entered. The path cost is used when establishing the active topology of the network. Lower path cost ports are chosen as forwarding ports in favour of higher path cost ports. Valid values are in the range 1 to 200000000.
- **Priority :**

Controls the port priority. This can be used to control priority of ports having identical port cost. (See above).
- **operEdge (state flag) :**

Operational flag describing whether the port is connecting directly to edge devices. (No Bridges attached). Transition to the forwarding state is faster for edge ports (having operEdge true) than for other ports. The value of this flag is based on AdminEdge and AutoEdge fields. This flag is displayed as Edge in Monitor->Spanning Tree -> STP Detailed Bridge Status.
- **AdminEdge :**

Controls whether the operEdge flag should start as set or cleared. (The initial operEdge state when a port is initialized).
- **AutoEdge :**

Controls whether the bridge should enable automatic edge detection on the bridge port. This allows operEdge to be derived from whether BPDU's are received on the port or not.
- **Restricted Role :**

If enabled, causes the port not to be selected as Root Port for the CIST or any MSTI, even if it has the best spanning tree priority vector. Such a port will be selected as an Alternate Port after the Root Port has been selected. If set, it can cause lack of spanning tree connectivity. It can be set by a network administrator to prevent bridges external to a core region of the network influence the spanning tree active topology, possibly because those bridges are not under the full control of the administrator. This feature is also known as Root Guard.
- **Restricted TCN :**

If enabled, causes the port not to propagate received topology change notifications and topology changes to other ports. If set it can cause temporary loss of connectivity after changes in a spanning tree's active topology as a result of persistently incorrect learned station location information. It is set by a network administrator to prevent bridges external to a core region of the network, causing address flushing in that region, possibly because those bridges are not under the full control of the administrator or the physical link state of the attached LANs transits frequently.
- **BPDU Guard :**

If enabled, causes the port to disable itself upon receiving valid BPDU's. Contrary to the similar bridge setting, the port Edge status does not affect this setting. A port entering error-disabled state due to this setting is subject to the bridge Port Error Recovery setting as well.

- **Point to Point**

Controls whether the port connects to a point-to-point LAN rather than to a shared medium. This can be automatically determined, or forced either true or false. Transition to the forwarding state is faster for point-to-point LANs than for shared media.

- **Buttons**

Apply – Click to save changes.

Reset- Click to undo any changes made locally and revert to previously saved values.

3-8.5 MSTI Ports

The section describes it allows the user to inspect the current STP MSTI port configurations, and possibly change them as well.

An MSTI port is a virtual port, which is instantiated separately for each active CIST (physical) port for each MSTI instance configured on and applicable to the port. The MSTI instance must be selected before displaying actual MSTI port configuration options. It contains MSTI port settings for physical and aggregated ports.

Web Interface

To configure the Spanning Tree MSTI Port Configuration parameters in the web interface:

1. Click Configuration, Spanning Tree, MSTI Ports
2. Scroll to select the MST1 or other MSTI Port
3. Click Get to set the detail parameters of the MSTI Ports.
4. Scroll to set all parameters of the MSTI Port configuration.
5. Click the save to save the setting
6. If you want to cancel the setting then you need to click the Reset button. It will revert to previously saved values

Figure 3-8.5: The MSTI Port Configuration

STP CIST Port Configuration
Home > Configuration > Spanning Tree > MSTI Ports

Select MSTI

MST1 ▾

Get

MSTI Normal Ports Configuration

Port	Path Cost		Priority
*	<> ▾	<input type="text"/>	<> ▾
1	Auto ▾	<input type="text"/>	128 ▾
2	Auto ▾	<input type="text"/>	128 ▾
3	Auto ▾	<input type="text"/>	128 ▾
24	Auto ▾	<input type="text"/>	128 ▾
25	Auto ▾	<input type="text"/>	128 ▾
26	Auto ▾	<input type="text"/>	128 ▾

Apply

Reset

Parameter description:

- **Port :**

The switch port number of the corresponding STP CIST (and MSTI) port.
- **Path Cost :**

Controls the path cost incurred by the port. The Auto setting will set the path cost as appropriate by the physical link speed, using the 802.1D recommended values. Using the Specific setting, a user-defined value can be entered. The path cost is used when establishing the active topology of the network. Lower path cost ports are chosen as forwarding ports in favour of higher path cost ports. Valid values are in the range 1 to 200000000.
- **Priority :**

Controls the port priority. This can be used to control priority of ports having identical port cost. (See above).
- **Buttons**
 - Apply** – Click to save changes.
 - Reset**- Click to undo any changes made locally and revert to previously saved values.

3-9 IPMC

ICMP is an acronym for Internet Control Message Protocol. It is a protocol that generated the error response, diagnostic or routing purposes. ICMP messages generally contain information about routing difficulties or simple exchanges such as time-stamp or echo transactions.

3-9.1 IGMP Snooping

The function, is used to establish the multicast groups to forward the multicast packet to the member ports, and, in nature, avoids wasting the bandwidth while IP multicast packets are running over the network. This is because a switch that does not support IGMP or IGMP Snooping cannot tell the multicast packet from the broadcast packet, so it can only treat them all as the broadcast packet. Without IGMP Snooping, the multicast packet forwarding function is plain and nothing is different from broadcast packet.

A switch supported IGMP Snooping with the functions of query, report and leave, a type of packet exchanged between IP Multicast Router/Switch and IP Multicast Host, can update the information of the Multicast table when a member (port) joins or leaves an IP Multicast Destination Address. With this function, once a switch receives an IP multicast packet, it will forward the packet to the members who joined in a specified IP multicast group before.

The packets will be discarded by the IGMP Snooping if the user transmits multicast packets to the multicast group that had not been built up in advance. IGMP mode enables the switch to issue IGMP function that you enable IGMP proxy or snooping on the switch, which connects to a router closer to the root of the tree. This interface is the upstream interface. The router on the upstream interface should be running IGMP.

3-9.1.1 Basic Configuration

The section describes how to set the basic IGMP snooping on the switch, which connects to a router closer to the root of the tree. This interface is the upstream interface. The router on the upstream interface should be running IGMP

Web Interface

To configure the IGMP Snooping parameters in the web interface:

1. Click Configuration, IPMC,IGMP Snooping, Basic Configuration
2. Evoke to select enable or disable which Global configuration
3. Evoke which port wants to become a Router Port or enable/ disable the Fast Leave function..
4. Scroll to set the Throtting parameter.
5. Click the apply to save the setting
6. If you want to cancel the setting then you need to click the Reset button. It will revert to previously saved values

Figure 3-9.1.1: The IGMP Snooping Configuration.

IGMP Snooping Configuration		Home > Configuration > IPMC > IGMP Snooping > Basic Configuration
Global Configuration		
Snooping Enabled	<input type="checkbox"/>	
Unregistered IPMCv4 Flooding Enabled	<input checked="" type="checkbox"/>	
IGMP SSM Range	<input type="text" value="232.0.0.0"/> / <input type="text" value="8"/>	
Leave Proxy Enabled	<input type="checkbox"/>	
Proxy Enabled	<input type="checkbox"/>	

Port Related Configuration			
Port	Router Port	Fast Leave	Throttling
*	<input type="checkbox"/>	<input type="checkbox"/>	<> ▼
1	<input type="checkbox"/>	<input type="checkbox"/>	unlimited ▼
2	<input type="checkbox"/>	<input type="checkbox"/>	unlimited ▼
3	<input type="checkbox"/>	<input type="checkbox"/>	unlimited ▼
24	<input type="checkbox"/>	<input type="checkbox"/>	unlimited ▼
25	<input type="checkbox"/>	<input type="checkbox"/>	unlimited ▼
26	<input type="checkbox"/>	<input type="checkbox"/>	unlimited ▼

Parameter description:

- **Snooping Enabled:**

Enable the Global IGMP Snooping.

- **Unregistered IPMCv4 Flooding enabled :**

Enable unregistered IPMCv4 traffic flooding.

- **IGMP SSM Range :**

SSM (Source-Specific Multicast) Range allows the SSM-aware hosts and routers run the SSM service model for the groups in the address range. Format: (IP address/ sub mask)

- **Leave Proxy Enable:**

Enable IGMP Leave Proxy. This feature can be used to avoid forwarding unnecessary leave messages to the router side.

- **Proxy Enabled :**

Enable IGMP Proxy. This feature can be used to avoid forwarding unnecessary join and leave messages to the router side.

- **Port :**

It shows the physical Port index of switch.

- **Router Port :**

Specify which ports act as router ports. A router port is a port on the Ethernet switch that leads towards the Layer 3 multicast device or IGMP querier.

If an aggregation member port is selected as a router port, the whole aggregation will act as a router port.

- **Fast Leave :**

Enable the fast leave on the port.

- **Throttling :**

Enable to limit the number of multicast groups to which a switch port can belong.

3-9.1.2 VLAN Configuration

The section describes the VLAN configuration setting process integrated with IGMP Snooping function. For Each setting page shows up to 99 entries from the VLAN table, default being 20, selected through the "entries per page" input field. When first visited, the web page will show the first 20 entries from the beginning of the VLAN Table. The first displayed will be the one with the lowest VLAN ID found in the VLAN Table. The "VLAN" input fields allow the user to select the starting point in the VLAN Table. Clicking the button will update the displayed table starting from that or the next closest VLAN Table match.

Web Interface

To configure the IGMP Snooping VLAN Configuration in the web interface:

1. Click Configuration, IPMC, IGMP Snooping, VLAN Configuration
2. Evoke to select enable or disable Snooping , IGMP Querier. Specify the parameters in the blank field.
3. Click the refresh to update the data or click << or >> to display previous entry or next entry.
4. Click the save to save the setting
5. If you want to cancel the setting then you need to click the Reset button. It will revert to previously saved values

Figure 3-9.1.2: The IGMP Snooping VLAN Configuration.

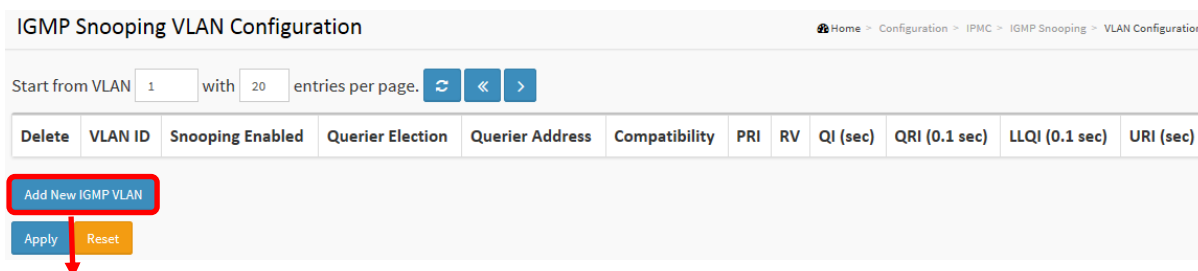
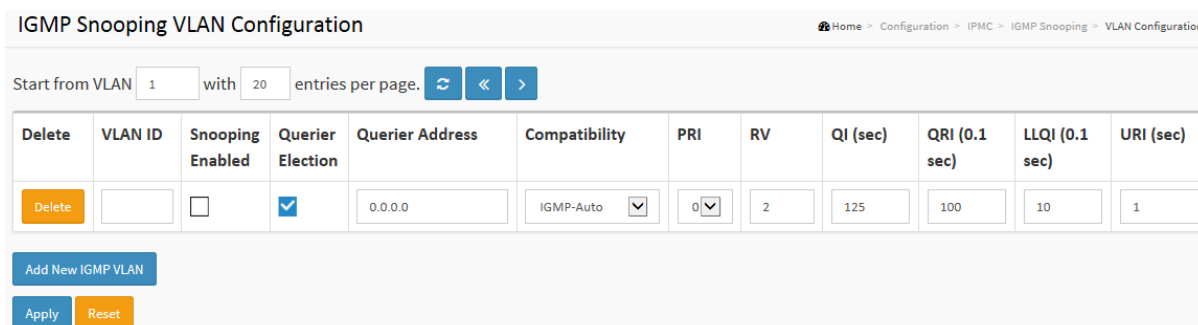
Parameter description:

- **Delete :**
Check to delete the entry. The designated entry will be deleted during the next save.
- **VLAN ID :**
It displays the VLAN ID of the entry.
- **IGMP Snooping Enabled :**
Enable the per-VLAN IGMP Snooping. Only up to 32 VLANs can be selected. .
- **Querier Election :**
Enable to join IGMP Querier election in the VLAN. Disable to act as an IGMP Non-Querier.
- **Querier Address :**

Define the IPv4 address as source address used in IP header for IGMP Querier election.

When the Querier address is not set, system uses IPv4 management address of the IP interface associated with this VLAN.

When the IPv4 management address is not set, system uses the first available IPv4 management address.

Otherwise, system uses a pre-defined value. By default, this value will be 192.0.2.1.

- **Compatibility :**

Compatibility is maintained by hosts and routers taking appropriate actions depending on the versions of IGMP operating on hosts and routers within a network. The allowed selection is IGMP-Auto, Forced IGMPv1, Forced IGMPv2, Forced IGMPv3, default compatibility value is IGMP-Auto.

- **PRI :**

Priority of Interface.

It indicates the IGMP control frame priority level generated by the system. These values can be used to prioritize different classes of traffic.

The allowed range is 0 (best effort) to 7 (highest), default interface priority value is 0.

- **Rv :**

Robustness Variable. The Robustness Variable allows tuning for the expected packet loss on a network. The allowed range is 1 to 255; default robustness variable value is 2.

- **QI :**

Query Interval. The Query Interval is the interval between General Queries sent by the Querier. The allowed range is 1 to 31744 seconds; default query interval is 125 seconds.

- **QRI :**

Query Response Interval. The Max Response Time used to calculate the Max Resp Code inserted into the periodic General Queries. The allowed range is 0 to 31744 in tenths of seconds; default query response interval is 100 in tenths of seconds (10 seconds).

- **LLQI (LMQI for IGMP) :**

Last Member Query Interval. The Last Member Query Time is the time value represented by the Last Member Query Interval, multiplied by the Last Member Query Count. The allowed range is 0 to 31744 in tenths of seconds; default last member query interval is 10 in tenths of seconds (1 second).

- **URI :**

Unsolicited Report Interval. The Unsolicited Report Interval is the time between repetitions of a host's initial report of membership in a group. The allowed range is 0 to 31744 seconds, default unsolicited report interval is 1 second. .

- **Buttons :**

Apply – Click to save changes.

Reset- Click to undo any changes made locally and revert to previously saved values.

- **Upper right icon (Refresh, |<<, >>) :**

You can click them Refreshes the displayed table starting from the "VLAN" input fields. Or click "|<<" to update the table starting from the first entry in the VLAN table, i.e. the entry with the lowest VLAN ID. Others click ">>" to update the table, starting with the entry after the last entry currently displayed.

3-10 LLDP

The switch supports the LLDP. For current information on your switch model, The Link Layer Discovery Protocol (LLDP) provides a standards-based method for enabling switches to advertise themselves to adjacent devices and to learn about adjacent LLDP devices. The Link Layer Discovery Protocol (LLDP) is a vendor-neutral Link Layer protocol in the Internet Protocol Suite used by network devices for advertising their identity, capabilities, and neighbors on a IEEE 802 local area network, principally wired Ethernet. The protocol is formally referred to by the IEEE as Station and Media Access Control Connectivity Discovery specified in standards document IEEE 802.1AB.

3-10.1 LLDP Configuration

You can per port to do the LLDP configuration and the detail parameters, the settings will take effect immediately. This page allows the user to inspect and configure the current LLDP port settings.

Web Interface

To configure LLDP:

1. Click LLDP configuration
2. Modify LLDP timing parameters
3. Set the required mode for transmitting or receiving LLDP messages
4. Specify the information to include in the TLV field of advertised messages
5. Click Apply

Figure 3-10.1: The LLDP Configuration

LLDP Configuration
Home > Configuration > LLDP > LLDP

LLDP Parameters

Tx Interval	30	seconds
Tx Hold	4	times
Tx Delay	2	seconds
Tx Reinit	2	seconds

LLDP Port Configuration

			Optional TLVs				
Port	Mode	CDP aware	Port Descr	Sys Name	Sys Descr	Sys Capa	Mgmt Addr
*	<> ▾	<input type="checkbox"/>	<input checked="" type="checkbox"/>	<input checked="" type="checkbox"/>	<input checked="" type="checkbox"/>	<input checked="" type="checkbox"/>	<input checked="" type="checkbox"/>
1	Enabled ▾	<input type="checkbox"/>	<input checked="" type="checkbox"/>	<input checked="" type="checkbox"/>	<input checked="" type="checkbox"/>	<input checked="" type="checkbox"/>	<input checked="" type="checkbox"/>
2	Enabled ▾	<input type="checkbox"/>	<input checked="" type="checkbox"/>	<input checked="" type="checkbox"/>	<input checked="" type="checkbox"/>	<input checked="" type="checkbox"/>	<input checked="" type="checkbox"/>
3	Enabled ▾	<input type="checkbox"/>	<input checked="" type="checkbox"/>	<input checked="" type="checkbox"/>	<input checked="" type="checkbox"/>	<input checked="" type="checkbox"/>	<input checked="" type="checkbox"/>

23	Enabled <input type="button" value="v"/>	<input type="checkbox"/>	<input checked="" type="checkbox"/>	<input checked="" type="checkbox"/>	<input checked="" type="checkbox"/>	<input checked="" type="checkbox"/>	<input checked="" type="checkbox"/>
24	Enabled <input type="button" value="v"/>	<input type="checkbox"/>	<input checked="" type="checkbox"/>	<input checked="" type="checkbox"/>	<input checked="" type="checkbox"/>	<input checked="" type="checkbox"/>	<input checked="" type="checkbox"/>
25	Enabled <input type="button" value="v"/>	<input type="checkbox"/>	<input checked="" type="checkbox"/>	<input checked="" type="checkbox"/>	<input checked="" type="checkbox"/>	<input checked="" type="checkbox"/>	<input checked="" type="checkbox"/>
26	Enabled <input type="button" value="v"/>	<input type="checkbox"/>	<input checked="" type="checkbox"/>	<input checked="" type="checkbox"/>	<input checked="" type="checkbox"/>	<input checked="" type="checkbox"/>	<input checked="" type="checkbox"/>

Parameter description:

LLDP Parameters

● **Tx Interval :**

The switch periodically transmits LLDP frames to its neighbours for having the network discovery information up-to-date. The interval between each LLDP frame is determined by the Tx Interval value. Valid values are restricted to 5 - 32768 seconds.

● **Tx Hold :**

Each LLDP frame contains information about how long the information in the LLDP frame shall be considered valid. The LLDP information valid period is set to Tx Hold multiplied by Tx Interval seconds. Valid values are restricted to 2 - 10 times.

● **Tx Delay :**

If some configuration is changed (e.g. the IP address) a new LLDP frame is transmitted, but the time between the LLDP frames will always be at least the value of Tx Delay seconds. Tx Delay cannot be larger than 1/4 of the Tx Interval value. Valid values are restricted to 1 - 8192 seconds.

● **Tx Reinit :**

When a port is disabled, LLDP is disabled or the switch is rebooted, an LLDP shutdown frame is transmitted to the neighboring units, signaling that the LLDP information isn't valid anymore. Tx Reinit controls the amount of seconds between the shutdown frame and a new LLDP initialization. Valid values are restricted to 1 - 10 seconds.

LLDP Port Configuration

The LLDP port settings relate to the currently selected, as reflected by the page header.

● **Port :**

The switch port number of the logical LLDP port.

● **Mode :**

Select LLDP mode.

Rx only The switch will not send out LLDP information, but LLDP information from neighbor units is analyzed.

Tx only The switch will drop LLDP information received from neighbors, but will send out LLDP information.

Disabled The switch will not send out LLDP information, and will drop LLDP information received from neighbors.

Enabled The switch will send out LLDP information, and will analyze LLDP information received from neighbors.

● **CDP Aware :**

Select CDP awareness.

The CDP operation is restricted to decoding incoming CDP frames (The switch doesn't transmit CDP frames). CDP frames are only decoded if LLDP on the port is enabled.

Only CDP TLVs that can be mapped to a corresponding field in the LLDP neighbors' table are decoded. All other TLVs are discarded (Unrecognized CDP TLVs and discarded CDP frames are not shown in the LLDP statistics.). CDP TLVs are mapped onto LLDP neighbors' table as shown below.

CDP TLV "Device ID" is mapped to the LLDP "Chassis ID" field.

CDP TLV "Address" is mapped to the LLDP "Management Address" field. The CDP address TLV can contain multiple addresses, but only the first address is shown in the LLDP neighbors' table.

CDP TLV "Port ID" is mapped to the LLDP "Port ID" field.

CDP TLV "Version and Platform" is mapped to the LLDP "System Description" field.

Both the CDP and LLDP support "system capabilities", but the CDP capabilities cover capabilities that are not part of the LLDP. These capabilities are shown as "others" in the LLDP neighbors' table.

If all ports have CDP awareness disabled the switch forwards CDP frames received from neighbor devices. If at least one port has CDP awareness enabled all CDP frames are terminated by the switch.



NOTE: When CDP awareness on a port is disabled the CDP information isn't removed immediately, but gets when the hold time is exceeded.

- **Port Descr :**

Optional TLV: When checked the "port description" is included in LLDP information transmitted.

- **Sys Name :**

Optional TLV: When checked the "system name" is included in LLDP information transmitted.

- **Sys Descr :**

Optional TLV: When checked the "system description" is included in LLDP information transmitted.

- **Sys Capa :**

Optional TLV: When checked the "system capability" is included in LLDP information transmitted.

- **Mgmt Addr :**

Optional TLV: When checked the "management address" is included in LLDP information transmitted.

- **Buttons:**

Apply – Click to save changes.

Reset- Click to undo any changes made locally and revert to previously saved values.

3-10.2 LLDP-MED Configuration

Media Endpoint Discovery is an enhancement of LLDP, known as LLDP-MED that provides the following facilities:

Auto-discovery of LAN policies (such as VLAN, Layer 2 Priority and Differentiated services (Diffserv) settings) enabling plug and play networking.

Device location discovery to allow creation of location databases and, in the case of Voice over Internet Protocol (VoIP), Enhanced 911 services.

Extended and automated power management of Power over Ethernet (PoE) end points.

Inventory management, allowing network administrators to track their network devices, and determine their characteristics (manufacturer, software and hardware versions, serial or asset number).

This page allows you to configure the LLDP-MED. This function applies to VoIP devices which support LLDP-MED.

Web Interface

To configure LLDP-MED:

1. Click LLDP-MED Configuration
2. Modify Fast start repeat count parameter, default is 4
3. Modify Coordinates Location parameters
4. Fill Civic Address Location parameters
5. Add new policy
6. Click Apply, will show following Policy Port Configuration
7. Select Policy ID for each port
8. Click Apply

Figure 3-10.2: The LLDP-MED Configuration

LLDP-MED Configuration
Home > Configuration > LLDP > LLDP-MED

Fast Start Repeat Count

Fast start repeat count	4
--------------------------------	---

Coordinates Location

Latitude	<input type="text" value="0"/> °	North <input type="button" value="v"/>	Longitude	<input type="text" value="0"/> °	East <input type="button" value="v"/>
Altitude	<input type="text" value="0"/>	Meters <input type="button" value="v"/>	Map Datum	WGS84 <input type="button" value="v"/>	

Civic Address Location

Country code	<input type="text"/>	State	<input type="text"/>	County	<input type="text"/>
City	<input type="text"/>	City district	<input type="text"/>	Block (Neighborhood)	<input type="text"/>
Street	<input type="text"/>	Leading street direction	<input type="text"/>	Trailing street suffix	<input type="text"/>
Street suffix	<input type="text"/>	House no.	<input type="text"/>	House no. suffix	<input type="text"/>
Landmark	<input type="text"/>	Additional location info	<input type="text"/>	Name	<input type="text"/>
Zip code	<input type="text"/>	Building	<input type="text"/>	Apartment	<input type="text"/>
Floor	<input type="text"/>	Room no.	<input type="text"/>	Place type	<input type="text"/>
Postal community name	<input type="text"/>	P.O. Box	<input type="text"/>	Additional code	<input type="text"/>

Emergency Call Service

Emergency Call Service

Policies

Delete	Policy ID	Application Type	Tag	VLAN ID	L2 Priority	DSCP
No entries present						

Parameter description:

Fast start repeat count

Rapid startup and Emergency Call Service Location Identification Discovery of endpoints is a critically important aspect of VoIP systems in general. In addition, it is best to advertise only those pieces of information which are specifically relevant to particular endpoint types (for example only advertise the voice network policy to permitted voice-capable devices), both in order to conserve the limited LLDPDU space and to reduce security and system integrity issues that can come with inappropriate knowledge of the network policy.

With this in mind LLDP-MED defines an LLDP-MED Fast Start interaction between the protocol and the application layers on top of the protocol, in order to achieve these related properties. Initially, a Network Connectivity Device will only transmit LLDP TLVs in an LLDPDU. Only after an LLDP-MED Endpoint Device is detected, will an LLDP-MED capable Network Connectivity Device start to advertise LLDP-MED TLVs in outgoing LLDPDUs on the associated port. The LLDP-MED application will temporarily speed up the transmission of the LLDPDU to start within a second, when a new LLDP-MED neighbour has been detected in order share LLDP-MED information as fast as possible to new neighbours.

Because there is a risk of an LLDP frame being lost during transmission between neighbours, it is recommended to repeat the fast start transmission multiple times to increase the possibility of the neighbours receiving the LLDP frame. With Fast start repeat count it is possible to specify the number of times the fast start transmission would be repeated. The recommended value is 4 times, given that 4 LLDP frames with a 1 second interval will be transmitted, when an LLDP frame with new information is received.

It should be noted that LLDP-MED and the LLDP-MED Fast Start mechanism is only intended to run on links between LLDP-MED Network Connectivity Devices and Endpoint Devices, and as such does not apply to links between LAN infrastructure elements, including Network Connectivity Devices, or other types of links.

Coordinates Location

- **Latitude :**

Latitude SHOULD be normalized to within 0-90 degrees with a maximum of 4 digits.

It is possible to specify the direction to either North of the equator or South of the equator.

- **Longitude :**

Longitude SHOULD be normalized to within 0-180 degrees with a maximum of 4 digits.

It is possible to specify the direction to either East of the prime meridian or West of the prime meridian.

- **Altitude :**

Altitude SHOULD be normalized to within -32767 to 32767 with a maximum of 4 digits.

It is possible to select between two altitude types (floors or meters).

Meters: Representing meters of Altitude defined by the vertical datum specified.

Floors: Representing altitude in a form more relevant in buildings which have different floor-to-floor dimensions. An altitude = 0.0 is meaningful even outside a building, and represents ground level at the given latitude and longitude. Inside a building, 0.0 represents the floor level associated with ground level at the main entrance.

- **Map Datum :**

The Map Datum is used for the coordinates given in these options:

WGS84: (Geographical 3D) - World Geodesic System 1984, CRS Code 4327, Prime Meridian Name: Greenwich.

NAD83/NAVD88: North American Datum 1983, CRS Code 4269, Prime Meridian Name: Greenwich; The associated vertical datum is the North American Vertical Datum of 1988 (NAVD88). This datum pair is to be used when referencing locations on land, not near tidal water (which would use Datum = NAD83/MLLW).

NAD83/MLLW: North American Datum 1983, CRS Code 4269, Prime Meridian Name: Greenwich; The associated vertical datum is Mean Lower Low Water (MLLW). This datum pair is to be used when referencing locations on water/sea/ocean.

Civic Address Location

IETF Geopriv Civic Address based Location Configuration Information (Civic Address LCI).

- **Country code :**

The two-letter ISO 3166 country code in capital ASCII letters - Example: DK, DE or US.

- **State :**

National subdivisions (state, canton, region, province, prefecture).

- **County :**

County, parish, gun (Japan), district.

- **City :**

City, township, shi (Japan) - Example: Copenhagen.

- **City district :**

City division, borough, city district, ward, chou (Japan).

- **Block (Neighbourhood) :**

Neighbourhood, block.

- **Street :**

Street - Example: Poppelvej.

- **Leading street direction :**

Leading street direction - Example: N.

- **Trailing street suffix :**

Trailing street suffix - Example: SW.

- **Street suffix :**

Street suffix - Example: Ave, Platz.

- **House no. :**

House number - Example: 21.

- **House no. suffix :**

House number suffix - Example: A, 1/2.

- **Landmark :**
Landmark or vanity address - Example: Columbia University.
- **Additional location info :**
Additional location info - Example: South Wing.
- **Name :**
Name (residence and office occupant) - Example: Flemming Jahn.
- **Zip code :**
Postal/zip code - Example: 2791.
- **Building :**
Building (structure) - Example: Low Library.
- **Apartment :**
Unit (Apartment, suite) - Example: Apt 42.
- **Floor :**
Floor - Example: 4.
- **Room no. :**
Room number - Example: 450F.
- **Place type :**
Place type - Example: Office.
- **Postal community name :**
Postal community name - Example: Leonia.
- **P.O. Box :**
Post office box (P.O. BOX) - Example: 12345.
- **Additional code :**
Additional code - Example: 1320300003.
- **Emergency Call Service:**
Emergency Call Service (e.g. E911 and others), such as defined by TIA or NENA.
- **Emergency Call Service :**
Emergency Call Service ELIN identifier data format is defined to carry the ELIN identifier as used during emergency call setup to a traditional CAMA or ISDN trunk-based PSAP. This format consists of a numerical digit string, corresponding to the ELIN to be used for emergency calling.

Policies

Network Policy Discovery enables the efficient discovery and diagnosis of mismatch issues with the VLAN configuration, along with the associated Layer 2 and Layer 3 attributes, which apply for a set of specific protocol applications on that port. Improper network policy configurations are a very significant issue in VoIP environments that frequently result in voice quality degradation or loss of service.

Policies are only intended for use with applications that have specific 'real-time' network policy requirements, such as interactive voice and/or video services.

The network policy attributes advertised are:

1. Layer 2 VLAN ID (IEEE 802.1Q-2003)
2. Layer 2 priority value (IEEE 802.1D-2004)
3. Layer 3 Diffserv code point (DSCP) value (IETF RFC 2474)

This network policy is potentially advertised and associated with multiple sets of application types supported on a given port. The application types specifically addressed are:

1. Voice
2. Guest Voice
3. Softphone Voice
4. Video Conferencing
5. Streaming Video
6. Control / Signalling (conditionally support a separate network policy for the media types above)

A large network may support multiple VoIP policies across the entire organization, and different policies per application type. LLDP-MED allows multiple policies to be advertised per port, each corresponding to a different application type. Different ports on the same Network Connectivity Device may advertise different sets of policies, based on the authenticated user identity or port configuration.

It should be noted that LLDP-MED is not intended to run on links other than between Network Connectivity Devices and Endpoints, and therefore does not need to advertise the multitude of network policies that frequently run on an aggregated link interior to the LAN.

- **Delete :**

Check to delete the policy. It will be deleted during the next save.

- **Policy ID :**

ID for the policy. This is auto generated and shall be used when selecting the policies that shall be mapped to the specific ports.

- **Application Type :**

Intended use of the application types:

1. Voice - for use by dedicated IP Telephony handsets and other similar appliances supporting interactive voice services. These devices are typically deployed on a separate VLAN for ease of deployment and enhanced security by isolation from data applications.
2. Voice Signalling (conditional) - for use in network topologies that require a different policy for the voice signalling than for the voice media. This application type should not be advertised if all the same network policies apply as those advertised in the Voice application policy.
3. Guest Voice - support a separate 'limited feature-set' voice service for guest users and visitors with their own IP Telephony handsets and other similar appliances supporting interactive voice services.
4. Guest Voice Signalling (conditional) - for use in network topologies that require a different policy for the guest voice signalling than for the guest voice media. This application type should not be advertised if all the same network policies apply as those advertised in the Guest Voice application policy.
5. Softphone Voice - for use by softphone applications on typical data centric devices, such as PCs or laptops. This class of endpoints frequently does not support multiple VLANs, if at all, and are typically configured to use an 'untagged' VLAN or a single 'tagged' data specific VLAN. When a network policy is defined for use with an 'untagged' VLAN (see Tagged flag below), then the L2 priority field is ignored and only the DSCP value has relevance.
6. Video Conferencing - for use by dedicated Video Conferencing equipment and other similar appliances supporting real-time interactive video/audio services.
7. Streaming Video - for use by broadcast or multicast based video content distribution and other similar applications supporting streaming video services that require specific network policy treatment. Video applications relying on TCP with buffering would not be an intended use of this application type.
8. Video Signalling (conditional) - for use in network topologies that require a separate

policy for the video signalling than for the video media. This application type should not be advertised if all the same network policies apply as those advertised in the Video Conferencing application policy.

- **Tag :**

Tag indicating whether the specified application type is using a 'tagged' or an 'untagged' VLAN.

Untagged indicates that the device is using an untagged frame format and as such does not include a tag header as defined by IEEE 802.1Q-2003. In this case, both the VLAN ID and the Layer 2 priority fields are ignored and only the DSCP value has relevance.

Tagged indicates that the device is using the IEEE 802.1Q tagged frame format, and that both the VLAN ID and the Layer 2 priority values are being used, as well as the DSCP value. The tagged format includes an additional field, known as the tag header. The tagged frame format also includes priority tagged frames as defined by IEEE 802.1Q-2003.

- **VLAN ID :**

VLAN identifier (VID) for the port as defined in IEEE 802.1Q-2003.

- **L2 Priority :**

L2 Priority is the Layer 2 priority to be used for the specified application type. L2 Priority may specify one of eight priority levels (0 through 7), as defined by IEEE 802.1D-2004. A value of 0 represents use of the default priority as defined in IEEE 802.1D-2004.

- **DSCP :**

DSCP value to be used to provide Diffserv node behaviour for the specified application type as defined in IETF RFC 2474. DSCP may contain one of 64 code point values (0 through 63). A value of 0 represents use of the default DSCP value as defined in RFC 2475.

- **Adding a new policy :**

Click to add a new policy. Specify the Application type, Tag, VLAN ID, L2 Priority and DSCP for the new policy. Click "Save".

- **Port Policies Configuration :**

Every port may advertise a unique set of network policies or different attributes for the same network policies, based on the authenticated user identity or port configuration.

- **Port :**

The port number to which the configuration applies.

- **Policy Id :**

The set of policies that shall apply to a given port. The set of policies is selected by check marking the checkboxes that corresponds to the policies.

- **Buttons:**

Apply – Click to save changes.

Reset- Click to undo any changes made locally and revert to previously saved values.

3- 11 PoE

PoE is an acronym for Power Over Ethernet.

Power Over Ethernet is used to transmit electrical power, to remote devices over standard Ethernet cable. It could for example be used for powering IP telephones, wireless LAN access points and other equipment, where it would be difficult or expensive to connect the equipment to main power supply.

The PoE detect function is follow the table

Stages of Powering up a PoE Link

Stage	Action	Volts specified [V]	
		802.3af	802.3at
Detection	PSE detects if the PD has the correct signature resistance of 19–26.5 kΩ	2.7-10.1	
Classification	PSE detects resistor indicating power range	14.5-20.5	
Mark 1	Signals PSE is 802.3at capable. PD presents a 0.25–4 mA load.	–	7-10
Class 2	PSE outputs classification voltage again to indicate 802.3at capability	–	14.5-20.5
Mark 2	Signals PSE is 802.3at capable. PD presents a 0.25–4 mA load.	–	7-10
Startup	Startup voltage	>42	>42
Normal operation	Supply power to device	37-45	42.5-57

Power levels available

Class	Usage	Power range [Watt]	Class description
0	Default	15.4	Classification unimplemented
1	Optional	4	Very Low power
2	Optional	7	Low power
3	Optional	15.4	Mid power
4	Valid for 802.3at (Type 2) devices, not allowed for 802.3af devices	30	High power

3- 11.1 Configuration

This page allows the user to inspect and configure the current PoE port settings and show all PoE Supply W.

Web Interface

To configure Power Over Ethernet in the web interface:

1. Click configuration, PoE, and configuration
2. Specify the Reserved Power determined and Power Management mode. Specify the PoE or PoE++ and Priority.
3. Click Apply.

Figure 3-11.1: The PoE Configuration

Power Over Ethernet Configuration
Home > Configuration > PoE > Configuration

Reserved Power determined by

Class

Allocation

LLDP-Med

Power Management Mode

Actual Consumption

Reserved Power

PoE Power Supply Configuration

Primary Power Supply [W]

PoE Port Configuration

Port	PoE Mode	Priority	Maximum Power [W]
*	<input type="text" value="<>"/>	<input type="text" value="<>"/>	<input type="text" value="15.4"/>

Apply
Reset

Parameter description:

Power Supply Configuration

- **Reserved Power determined by :**

There are three modes for configuring how the ports/PDs may reserve power.

1. Allocated mode: In this mode the user allocates the amount of power that each port may reserve. The allocated/reserved power for each port/PD is specified in the Maximum Power fields.

2. Class mode: In this mode each port automatically determines how much power to reserve according to the class the connected PD belongs to, and reserves the power accordingly. Four different port classes exist and one for 4, 7, 15.4 or 30 Watts. In this mode the Maximum Power fields have no effect.

3. LLDP-MED mode: This mode is similar to the Class mode expect that each port determine the amount power it reserves by exchanging PoE information using the LLDP protocol and reserves power accordingly. If no LLDP information is available for a port, the port will reserve power using the class mode. In this mode the Maximum Power fields have no effect. For all modes: If a port uses more power than the reserved power for the port, the port is shut down.

- **Power Management Mode :**

There are 2 modes for configuring when to shut down the ports:

1. Actual Consumption: In this mode the ports are shut down when the actual power consumption for all ports exceeds the amount of power that the power supply can deliver or if the actual power consumption for a given port exceeds the reserved power for that port. The ports are shut down according to the ports priority. If two ports have the same priority the port with the highest port number is shut down.

2. Reserved Power: In this mode the ports are shut down when total reserved powered exceeds the amount of power that the power supply can deliver. In this mode the port power is not turned on if the PD requests more power than available from the power supply.

- **Primary and Backup Power Source :**

Some switches support having two PoE power supplies. One is used as primary power source, and one as backup power source. If the switch doesn't support backup power supply only the primary power supply settings will be shown. In case that the primary power source fails the backup power source will take over. For being able to determine the amount

of power the PD may use, it must be defined what amount of power the primary and backup power sources can deliver.

Valid values are in the range 0 to 2000 Watts.

- **Port :**

This is the logical port number for this row.

Ports that are not PoE-capable are grayed out and thus impossible to configure PoE for.

- **PoE Mode :**

The PoE Mode represents the PoE operating mode for the port.

Disabled: PoE disabled for the port.

PoE : Enables PoE IEEE 802.3af (Class 4 PDs limited to 15.4W)

PoE+ : Enables PoE+ IEEE 802.3at (Class 4 PDs limited to 30W)

- **Priority :**

The Priority represents the ports priority. There are three levels of power priority named Low, High and Critical.

The priority is used in the case where the remote devices requires more power than the power supply can deliver. In this case the port with the lowest priority will be turn off starting from the port with the highest port number.

- **Maximum Power :**

The Maximum Power value contains a numerical value that indicates the maximum power in watts that can be delivered to a remote device.

The maximum allowed value is 30 W.

3- 11.2 Power Delay

This page allows the user to setting the delay time of power providing after device rebooted.

Web Interface

To Display Power Over Ethernet Status in the web interface:

1. Click Configuration, PoE, and Power delay.
2. Enable the port to the power device.
3. Specify the power providing delay time when reboot.
4. Click Apply to apply the change.

Figure 3-11.2: The PoE Power Delay

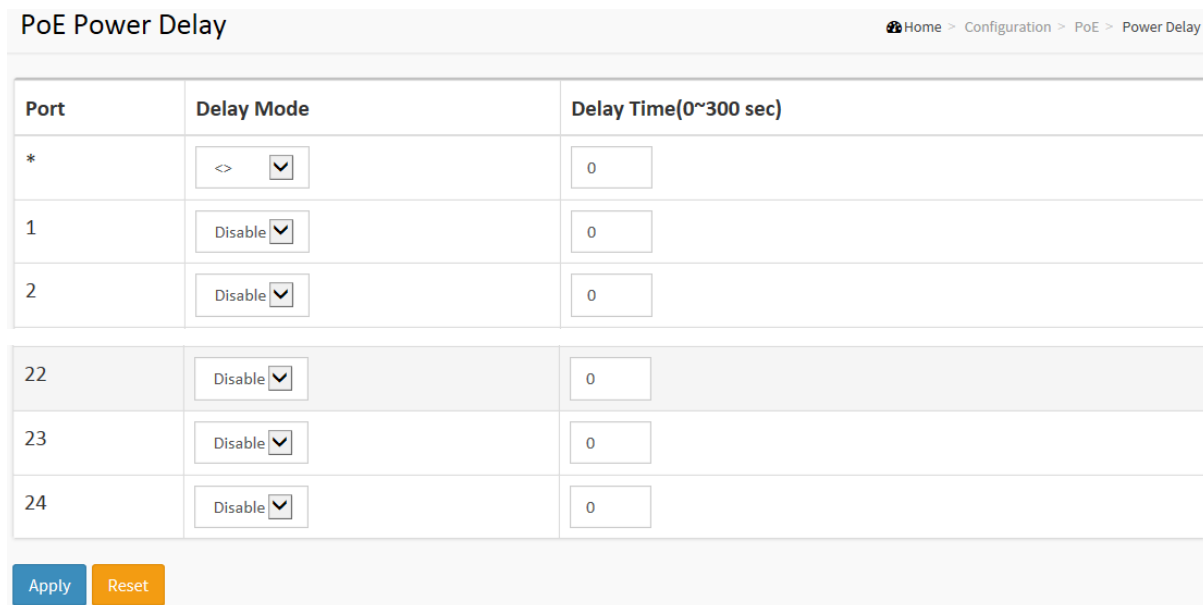

Port	Delay Mode	Delay Time(0~300 sec)
*	<> ▼	0
1	Disable ▼	0
2	Disable ▼	0
22	Disable ▼	0
23	Disable ▼	0
24	Disable ▼	0

Apply Reset

Parameter description:

Power Supply Configuration

- **Port :**
This is the logical port number for this row.
- **Delay Mode :**
Turn on / off the power delay function.
Enabled: Enable POE Power Delay.
Disabled: Disable POE Power Delay.
- **Delay Time(0~300sec) :**
When rebooting, the PoE port will start to provide power to the PD when it out of delay time.
default: 0, range: 0-300 sec.

3- 11.3 Scheduling

This page allows the user to make a perfect schedule of PoE power supply. PoE Scheduling not only makes PoE management easier but also saves more energy

Web Interface

To Display Power Over Ethernet Scheduling in the web interface:

1. Click Configuration, PoE, and Scheduling.
2. Select the local port and enable.
3. Select time and day to supply power.
4. Click Apply to apply the change.

Figure 3-11.2: The PoE Scheduling

PoE Scheduling Home > Configuration > PoE > Scheduling

Port	1	2	3	4	5	6	7	8	9	10	11	12	13	14	15	16	17	18	19	20	21	22	23	24
Status	✘	✘	✘	✘	✘	✘	✘	✘	✘	✘	✘	✘	✘	✘	✘	✘	✘	✘	✘	✘	✘	✘	✘	✘

Port:

Status:

Select All

Hour	Sunday	Monday	Tuesday	Wednesday	Thursday	Friday	Saturday
0	<input type="checkbox"/>	<input type="checkbox"/>	<input type="checkbox"/>	<input type="checkbox"/>	<input type="checkbox"/>	<input type="checkbox"/>	<input type="checkbox"/>
1	<input type="checkbox"/>	<input type="checkbox"/>	<input type="checkbox"/>	<input type="checkbox"/>	<input type="checkbox"/>	<input type="checkbox"/>	<input type="checkbox"/>
2	<input type="checkbox"/>	<input type="checkbox"/>	<input type="checkbox"/>	<input type="checkbox"/>	<input type="checkbox"/>	<input type="checkbox"/>	<input type="checkbox"/>
3	<input type="checkbox"/>	<input type="checkbox"/>	<input type="checkbox"/>	<input type="checkbox"/>	<input type="checkbox"/>	<input type="checkbox"/>	<input type="checkbox"/>
20	<input type="checkbox"/>	<input type="checkbox"/>	<input type="checkbox"/>	<input type="checkbox"/>	<input type="checkbox"/>	<input type="checkbox"/>	<input type="checkbox"/>
21	<input type="checkbox"/>	<input type="checkbox"/>	<input type="checkbox"/>	<input type="checkbox"/>	<input type="checkbox"/>	<input type="checkbox"/>	<input type="checkbox"/>
22	<input type="checkbox"/>	<input type="checkbox"/>	<input type="checkbox"/>	<input type="checkbox"/>	<input type="checkbox"/>	<input type="checkbox"/>	<input type="checkbox"/>
23	<input type="checkbox"/>	<input type="checkbox"/>	<input type="checkbox"/>	<input type="checkbox"/>	<input type="checkbox"/>	<input type="checkbox"/>	<input type="checkbox"/>

Parameter description:

Power Supply Configuration

- **Port :**
This is the logical port number for this row.
- **Status :**

PoE Scheduling Status.

Enabled: Enable POE Scheduling.

Disabled: Disable POE Scheduling.

- **Hour :**

The time of PoE port provide power of a day.

3- 11.4 Auto Checking

This page allows the user to specify the auto detection parameters to check the linking status between PoE ports and PDs. When it detected the fail connect, will reboot remote PD automatically.

Web Interface

To Display Power Over Ethernet Auto Checking in the web interface:

1. Click Configuration, PoE, and Auto checking.
2. Enable the Ping Check function.
3. Specify the PD's IP address, checking interval, retry time, failure action and reboot time.
4. Click Apply to apply the change.

Figure 3-11.2: The PoE Scheduling

PoE Auto Checking Home > Configuration > PoE > Auto Checking

Ping Check Disable ▾

Port	Ping IP Address	Start up Time	Interval Time(sec)	Retry Time	Failure Log	Failure Action	Power OFF Time(sec)
1	<input type="text" value="0.0.0.0"/>	<input type="text" value="30"/>	<input type="text" value="3"/>	<input type="text" value="0"/>	error=0, total=0	Nothing ▾	NaN
2	<input type="text" value="0.0.0.0"/>	<input type="text" value="30"/>	<input type="text" value="3"/>	<input type="text" value="0"/>	error=0, total=0	Nothing ▾	NaN
22	<input type="text" value="0.0.0.0"/>	<input type="text" value="30"/>	<input type="text" value="3"/>	<input type="text" value="0"/>	error=0, total=0	Nothing ▾	NaN
23	<input type="text" value="0.0.0.0"/>	<input type="text" value="30"/>	<input type="text" value="3"/>	<input type="text" value="0"/>	error=0, total=0	Nothing ▾	NaN
24	<input type="text" value="0.0.0.0"/>	<input type="text" value="30"/>	<input type="text" value="3"/>	<input type="text" value="0"/>	error=0, total=0	Nothing ▾	NaN

Parameter description:

Power Supply Configuration

- **Ping Check :**
Enable Ping Check function can detects the connection between PoE port and power device. Disable will turn off the detection.
- **Port :**
This is the logical port number for this row.
- **Ping IP Address :**
The PD's IP Address the system should ping.
- **Start up Time(sec) :**
When PD has been start up, the Switch will wait Start up time to do PoE Auto Checking. default: 60, range: 30-600 sec.
- **Interval Time(sec) :**
Device will send checking message to PD each interval time. default: 30, range: 10-120 sec.
- **Retry Time :**
When PoE port can't ping the PD, it will retry to send detection again. When the third time, it

will trigger failure action. default: 3, range: 1-5.

- **Failure Log :**

Failure loggings counter.

- **Failure Action :**

The action when the third fail detection.

Nothing: Keep Ping the remote PD but does nothing further.

Reboot Remote PD: Cut off the power of the PoE port, make PD rebooted.

- **Power OFF Time(sec) :**

When PD has been rebooted, the PoE port restored power after the specified time. default: 15, range: 3-120 sec.

3-12 MAC Table

Switching of frames is based upon the DMAC address contained in the frame. The switch builds up a table that maps MAC addresses to switch ports for knowing which ports the frames should go to (based upon the DMAC address in the frame). This table contains both static and dynamic entries. The static entries are configured by the network administrator if the administrator wants to do a fixed mapping between the DMAC address and switch ports.

The frames also contain a MAC address (SMAC address), which shows the MAC address of the equipment sending the frame. The SMAC address is used by the switch to automatically update the MAC table with these dynamic MAC addresses. Dynamic entries are removed from the MAC table if no frames with the corresponding SMAC addresses have been seen after a configurable age time

Web Interface

To configure MAC Address Table in the web interface:

Ageing Configuration

1. Click configuration.
2. Specify the Disable Automatic Aging and Aging Time.
3. Click Apply.

MAC Table Learning

1. Click configuration.
2. Specify the Port Members (Auto,Disable,Secure).
3. Click Apply.

Static MAC Table Configuration

1. Click configuration and Add new Static entry.
2. Specify the VLAN ID and Mac address, Port Members.
3. Click Apply.

Figure 3-12: The MAC Address Table Configuration

MAC Address Table Configuration Home > Configuration > MAC Table

Ageing Configuration

Disable Automatic Aging	<input type="checkbox"/>
Aging Time	300 seconds

MAC Table Learning

	Port Members																										
	1	2	3	4	5	6	7	8	9	10	11	12	13	14	15	16	17	18	19	20	21	22	23	24	25	26	
Auto	✓	✓	✓	✓	✓	✓	✓	✓	✓	✓	✓	✓	✓	✓	✓	✓	✓	✓	✓	✓	✓	✓	✓	✓	✓	✓	✓
Disable	○	○	○	○	○	○	○	○	○	○	○	○	○	○	○	○	○	○	○	○	○	○	○	○	○	○	○
Secure	○	○	○	○	○	○	○	○	○	○	○	○	○	○	○	○	○	○	○	○	○	○	○	○	○	○	○

Static MAC Table Configuration

			Port Members																									
Delete	VLAN ID	MAC Address	1	2	3	4	5	6	7	8	9	10	11	12	13	14	15	16	17	18	19	20	21	22	23	24	25	26
Add New Static Entry																												
Apply																												
Reset																												

Parameter description:

- **Aging Configuration :**

By default, dynamic entries are removed from the MAC table after 300 seconds. This removal is also called aging.

Configure aging time by entering a value here in seconds; for example, Age time seconds.

The allowed range is 10 to 1000000 seconds.

Disable the automatic aging of dynamic entries by checking Disable automatic aging.

MAC Table Learning

If the learning mode for a given port is greyed out, another module is in control of the mode, so that it cannot be changed by the user. An example of such a module is the MAC-Based Authentication under 802.1X. Each port can do learning based upon the following settings:

- **Auto :**

Learning is done automatically as soon as a frame with unknown SMAC is received.

- **Disable :**

No learning is done.

- **Secure :**

Only static MAC entries are learned, all other frames are dropped.



NOTE: Make sure that the link used for managing the switch is added to the Static Mac Table before changing to secure learning mode, otherwise the management link is lost and can only be restored by using another non-secure port or by connecting to the switch via the serial interface.

Static MAC Table Configuration

The static entries in the MAC table are shown in this table. The static MAC table can contain 64 entries. The maximum of 64 entries is for the whole stack, and not per switch.

The MAC table is sorted first by VLAN ID and then by MAC address.

- **Delete :**

Check to delete the entry. It will be deleted during the next save.

- **VLAN ID :**

The VLAN ID of the entry.

- **MAC Address :**

The MAC address of the entry.

- **Port Members :**

Checkmarks indicate which ports are members of the entry. Check or uncheck as needed to modify the entry.

- **Adding a New Static Entry :**

Click to add a new entry to the static MAC table. Specify the VLAN ID, MAC address, and port members for the new entry. Click "Apply".

- **Buttons:**

Apply – Click to save changes.

Reset- Click to undo any changes made locally and revert to previously saved values.

3-13 VLANs

To assign a specific VLAN for management purpose. The management VLAN is used to establish an IP connection to the switch from a workstation connected to a port in the VLAN. This connection supports a VSM, SNMP session. By default, the active management VLAN is VLAN 1, but you can designate any VLAN as the management VLAN using the Management VLAN window. Only one management VLAN can be active at a time.

When you specify a new management VLAN, your HTTP connection to the old management VLAN is lost. For this reason, you should have a connection between your management station and a port in the new management VLAN or connect to the new management VLAN through a multi-VLAN route

Web Interface

To configure VLAN membership configuration in the web interface:

1. Click Configuration VLANs.
2. Specify Existing VLANs, Ethertype for Custom S-ports
3. Click Apply.

Figure 3-13.1: The VLAN Configuration

VLAN Configuration Home > Configuration > VLANs

Global VLAN Configuration

Allowed Access VLANs	<input type="text" value="1"/>
Ethertype for Custom S-ports	<input type="text" value="88A8"/>

Port VLAN Configuration

Port	Mode	Port VLAN	Port Type	Ingress Filtering	Ingress Acceptance	Egress Tagging	Allowed VLANs	Forbidden VLANs
*	<> ▾	1	<> ▾	<input checked="" type="checkbox"/>	<> ▾	<> ▾	<input type="text" value="1"/>	<input type="text"/>
1	Access ▾	1	C-Port ▾	<input checked="" type="checkbox"/>	Tagged and Untagged ▾	Untag Port VLAN ▾	<input type="text" value="1"/>	<input type="text"/>
2	Access ▾	1	C-Port ▾	<input checked="" type="checkbox"/>	Tagged and Untagged ▾	Untag Port VLAN ▾	<input type="text" value="1"/>	<input type="text"/>
22	Access ▾	1	C-Port ▾	<input checked="" type="checkbox"/>	Tagged and Untagged ▾	Untag Port VLAN ▾	<input type="text" value="1"/>	<input type="text"/>
23	Access ▾	1	C-Port ▾	<input checked="" type="checkbox"/>	Tagged and Untagged ▾	Untag Port VLAN ▾	<input type="text" value="1"/>	<input type="text"/>
24	Access ▾	1	C-Port ▾	<input checked="" type="checkbox"/>	Tagged and Untagged ▾	Untag Port VLAN ▾	<input type="text" value="1"/>	<input type="text"/>
25	Access ▾	1	C-Port ▾	<input checked="" type="checkbox"/>	Tagged and Untagged ▾	Untag Port VLAN ▾	<input type="text" value="1"/>	<input type="text"/>
26	Access ▾	1	C-Port ▾	<input checked="" type="checkbox"/>	Tagged and Untagged ▾	Untag Port VLAN ▾	<input type="text" value="1"/>	<input type="text"/>

Parameter description:

Global VLAN Configuration

- **Existing VLANs :**

This field shows the VLANs that are created on the switch.

By default, only VLAN 1 exists. More VLANs may be created by using a list syntax where the individual elements are separated by commas. Ranges are specified with a dash separating the lower and upper bound.

The following example will create VLANs 1, 10, 11, 12, 13, 200, and 300: 1,10-13,200,300.

Spaces are allowed in between the delimiters.

- **Ethertype for Custom S-ports :**

This field specifies the ethertype/TPID (specified in hexadecimal) used for Custom S-ports. The setting is in force for all ports whose Port Type is set to S-Custom-Port.

Port VLAN Configuration

- **Port :**

This is the logical port number of this row.

- **Mode :**

The port mode (default is Access) determines the fundamental behavior of the port in question. A port can be in one of three modes as described below.

Whenever a particular mode is selected, the remaining fields in that row will be either grayed out or made changeable depending on the mode in question.

Grayed out fields show the value that the port will get when the mode is applied.

Access:

Access ports are normally used to connect to end stations. Dynamic features like Voice VLAN may add the port to more VLANs behind the scenes. Access ports have the following characteristics:

- Member of exactly one VLAN, the Port VLAN (a.k.a. Access VLAN), which by default is 1,
- accepts untagged frames and C-tagged frames,
- discards all frames that are not classified to the Access VLAN,
- on egress all frames are transmitted untagged.

Trunk:

Trunk ports can carry traffic on multiple VLANs simultaneously, and are normally used to connect to other switches. Trunk ports have the following characteristics:

- By default, a trunk port is member of all [existing VLANs](#). This may be limited by the use of [Allowed VLANs](#),
- unless [VLAN Trunking](#) is enabled on the port, frames classified to a VLAN that the port is not a member of will be discarded,
- by default, all frames but frames classified to the Port VLAN (a.k.a. Native VLAN) get tagged on egress. Frames classified to the Port VLAN do not get C-tagged on egress,
- egress tagging can be changed to tag all frames, in which case only tagged frames are accepted on ingress,
- VLAN trunking may be enabled.

Hybrid:

Hybrid ports resemble trunk ports in many ways, but adds additional port configuration features. In addition to the characteristics described for trunk ports, hybrid ports have these abilities:

- Can be configured to be VLAN tag unaware, C-tag aware, S-tag aware, or S-custom-tag aware,
- ingress filtering can be controlled,
- ingress acceptance of frames and configuration of egress tagging can be configured independently.

- **Port VLAN :**

Determines the port's VLAN ID (a.k.a. PVID). Allowed VLANs are in the range 1 through 4095, default being 1.

On ingress, frames get classified to the Port VLAN if the port is configured as VLAN unaware, the frame is untagged, or VLAN awareness is enabled on the port, but the frame is priority tagged (VLAN ID = 0).

On egress, frames classified to the Port VLAN do not get tagged if [Egress Tagging](#) configuration is set to untag Port VLAN.

The Port VLAN is called an "Access VLAN" for ports in Access mode and Native VLAN for ports in Trunk or Hybrid mode.

- **Port Type :**

Ports in hybrid mode allow for changing the port type, that is, whether a frame's VLAN tag is used to classify the frame on ingress to a particular VLAN, and if so, which TPID it reacts on. Likewise, on egress, the Port Type determines the TPID of the tag, if a tag is required.

Unaware:

On ingress, all frames, whether carrying a VLAN tag or not, get classified to the Port VLAN, and possible tags are not removed on egress.

C-Port:

On ingress, frames with a VLAN tag with TPID = 0x8100 get classified to the VLAN ID embedded in the tag. If a frame is untagged or priority tagged, the frame gets classified to the Port VLAN. If frames must be tagged on egress, they will be tagged with a C-tag.

S-Port:

On ingress, frames with a VLAN tag with TPID = 0x8100 or 0x88A8 get classified to the VLAN ID embedded in the tag. If a frame is untagged or priority tagged, the frame gets classified to the Port VLAN. If frames must be tagged on egress, they will be tagged with an S-tag.

S-Custom-Port:

On ingress, frames with a VLAN tag with a TPID = 0x8100 or equal to the [Ethertype configured for Custom-S ports](#) get classified to the VLAN ID embedded in the tag. If a frame is untagged or priority tagged, the frame gets classified to the Port VLAN. If frames must be tagged on egress, they will be tagged with the custom S-tag.

- **Ingress Filtering :**

Hybrid ports allow for changing ingress filtering. Access and Trunk ports always have ingress filtering enabled.

If ingress filtering is enabled (checkbox is checked), frames classified to a VLAN that the port is not a member of get discarded.

If ingress filtering is disabled, frames classified to a VLAN that the port is not a member of are accepted and forwarded to the switch engine. However, the port will never transmit frames classified to VLANs that it is not a member of.

- **VLAN Trunking :**

Trunk and Hybrid ports allow for enabling VLAN trunking.

When VLAN trunking is enabled, frames classified to unknown VLANs are accepted on the port whether ingress filtering is enabled or not.

This is useful in scenarios where a cloud of intermediary switches must bridge VLANs that haven't been created. By configuring the ports that connect the cloud of switches as trunking ports, they can seamlessly carry those VLANs from one end to the other.

- **Ingress Acceptance :**

Hybrid ports allow for changing the type of frames that are accepted on ingress.

Tagged and Untagged

Both tagged and untagged frames are accepted.

Tagged Only

Only tagged frames are accepted on ingress. Untagged frames are discarded.

Untagged Only

Only untagged frames are accepted on ingress. Tagged frames are discarded.

- **Egress Tagging :**

Ports in Trunk and Hybrid mode may control the tagging of frames on egress.

Untag Port VLAN

Frames classified to the Port VLAN are transmitted untagged. Other frames are transmitted with the relevant tag.

Tag All

All frames, whether classified to the Port VLAN or not, are transmitted with a tag.

Untag All

All frames, whether classified to the Port VLAN or not, are transmitted without a tag.

This option is only available for ports in Hybrid mode.

- **Allowed VLANs :**

Ports in Trunk and Hybrid mode may control which VLANs they are allowed to become members of. Access ports can only be member of one VLAN, the Access VLAN.

The field's syntax is identical to the syntax used in the [Existing VLANs](#) field. By default, a port may become member of all possible VLANs, and is therefore set to **1-4095**.

The field may be left empty, which means that the port will not be member of any of the existing VLANs, but if it is configured for [VLAN Trunking](#) it will still be able to carry all unknown VLANs.

- **Forbidden VLANs :**

A port may be configured to never be member of one or more VLANs. This is particularly useful when

dynamic VLAN protocols like MVRP and GVRP must be prevented from dynamically adding ports to VLANs.

The trick is to mark such VLANs as forbidden on the port in question. The syntax is identical to the syntax used in the [Existing VLANs](#) field.

By default, the field is left blank, which means that the port may become a member of all possible VLANs.

3-14 Private VLANs

In a private VLAN, communication between ports in that private VLAN is not permitted. A VLAN can be configured as a private VLAN.

3-14.1 VLAN Membership

The VLAN membership configuration for the selected stack switch unit switch can be monitored and modified here. Up to 4096 VLANs are supported. This page allows for adding and deleting VLANs as well as adding and deleting port members of each VLAN.

Web Interface

To configure VLAN membership configuration in the web interface:

1. Click VLAN membership Configuration.
2. Specify Management VLAN ID. 0~ 4094
3. Click Apply.

Figure 3-14.1: The VLAN Membership Configuration

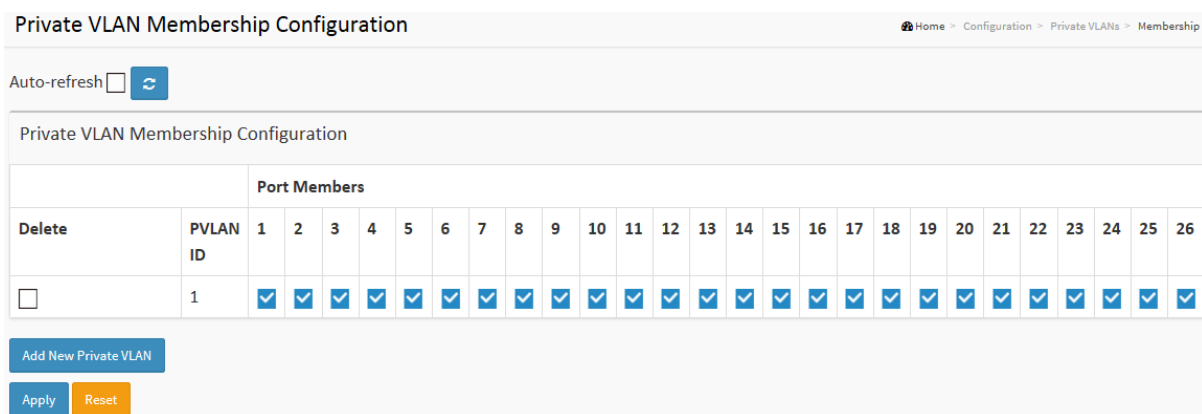

Private VLAN Membership Configuration		Port Members																									
Delete	PVLAN ID	1	2	3	4	5	6	7	8	9	10	11	12	13	14	15	16	17	18	19	20	21	22	23	24	25	26
<input type="checkbox"/>	1	<input checked="" type="checkbox"/>	<input checked="" type="checkbox"/>	<input checked="" type="checkbox"/>	<input checked="" type="checkbox"/>	<input checked="" type="checkbox"/>	<input checked="" type="checkbox"/>	<input checked="" type="checkbox"/>	<input checked="" type="checkbox"/>	<input checked="" type="checkbox"/>	<input checked="" type="checkbox"/>	<input checked="" type="checkbox"/>	<input checked="" type="checkbox"/>	<input checked="" type="checkbox"/>	<input checked="" type="checkbox"/>	<input checked="" type="checkbox"/>	<input checked="" type="checkbox"/>	<input checked="" type="checkbox"/>	<input checked="" type="checkbox"/>	<input checked="" type="checkbox"/>	<input checked="" type="checkbox"/>	<input checked="" type="checkbox"/>	<input checked="" type="checkbox"/>	<input checked="" type="checkbox"/>	<input checked="" type="checkbox"/>	<input checked="" type="checkbox"/>	<input checked="" type="checkbox"/>

Parameter description:

- **Delete :**
To delete a private VLAN entry, check this box. The entry will be deleted during the next save.
- **PVLAN ID :**
Indicates the ID of this particular private VLAN.
- **Port Members :**
A row of check boxes for each port is displayed for each VLAN ID. To include a port in a VLAN, check the box. To remove or exclude the port from the VLAN, make sure the box is unchecked. By default, no ports are members, and all boxes are unchecked.
- **Adding a New VLAN :**
Click to add a new VLAN ID. An empty row is added to the table, and the VLAN can be configured as needed. Legal values for a VLAN ID are 1 through 4095.
The VLAN is enabled on the selected stack switch unit when you click on "Save". The VLAN is thereafter present on the other stack switch units, but with no port members. The check box is greyed out when VLAN is displayed on other stacked switches, but user can add member ports to it.
A VLAN without any port members on any stack unit will be deleted when you click "Save".

The button can be used to undo the addition of new VLANs.

- **Buttons:**

Apply – Click to save changes.

Reset- Click to undo any changes made locally and revert to previously saved values.

3-14.2 Port Isolation

Port Isolation provides for an apparatus and method to isolate ports on layer 2 switches on the same VLAN to restrict traffic flow. The apparatus comprises a switch having said plurality of ports, each port configured as a protected port or a non-protected port. An address table memory stores an address table having a destination address and port number pair. A forwarding map generator generates a forwarding map which is responsive to a destination address of a data packet. The method for isolating ports on a layer 2 switch comprises configuring each of the ports on the layer 2 switch as a protected port or a non-protected port. A destination address on a data packet is matched with a physical address on said layer 2 switch and a forwarding map is generated for the data packet based upon the destination address on the data packet. The data packet is then sent to the plurality of ports pursuant to the forwarding map generated based upon whether the ingress port was configured as a protected or non-protected port.

This page is used for enabling or disabling port isolation on ports in a Private VLAN. A port member of a VLAN can be isolated to other isolated ports on the same VLAN and Private VLAN.

Web Interface

To configure Port Isolation configuration in the web interface:

1. Click Private VLAN, Port Isolation.
2. Evoke which port want to enable Port Isolation
3. Click Apply.

Figure 3-14.1: The Port Isolation Configuration

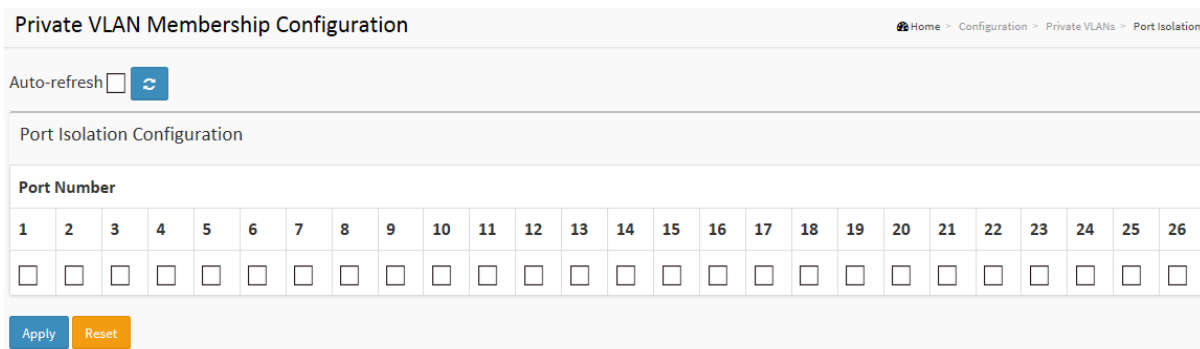

Port Isolation Configuration																										
Port Number																										
1	2	3	4	5	6	7	8	9	10	11	12	13	14	15	16	17	18	19	20	21	22	23	24	25	26	
<input type="checkbox"/>	<input type="checkbox"/>	<input type="checkbox"/>	<input type="checkbox"/>	<input type="checkbox"/>	<input type="checkbox"/>	<input type="checkbox"/>	<input type="checkbox"/>	<input type="checkbox"/>	<input type="checkbox"/>	<input type="checkbox"/>	<input type="checkbox"/>	<input type="checkbox"/>	<input type="checkbox"/>	<input type="checkbox"/>	<input type="checkbox"/>	<input type="checkbox"/>	<input type="checkbox"/>	<input type="checkbox"/>	<input type="checkbox"/>	<input type="checkbox"/>	<input type="checkbox"/>	<input type="checkbox"/>	<input type="checkbox"/>	<input type="checkbox"/>	<input type="checkbox"/>	<input type="checkbox"/>

Parameter description:

- **Port Members :**

A check box is provided for each port of a private VLAN. When checked, port isolation is enabled on that port. When unchecked, port isolation is disabled on that port. By default, port isolation is disabled on all ports.

- **Buttons:**

Apply – Click to save changes.

Reset- Click to undo any changes made locally and revert to previously saved values.

3-15 VCL

3-15.1 MAC-based VLAN

MAC address-based VLAN decides the VLAN for forwarding an untagged frame based on the source MAC address of the frame.

A most common way of grouping VLAN members is by port, hence the name port-based VLAN. Typically, the device adds the same VLAN tag to untagged packets that are received through the same port. Later on, these packets can be forwarded in the same VLAN. Port-based VLAN is easy to configure, and applies to networks where the locations of terminal devices are relatively fixed. As mobile office and wireless network access gain more popularity, the ports that terminal devices use to access the networks are very often non-fixed. A device may access a network through Port A this time, but through Port B the next time. If Port A and Port B belong to different VLANs, the device will be assigned to a different VLAN the next time it accesses the network. As a result, it will not be able to use the resources in the old VLAN. On the other hand, if Port A and Port B belong to the same VLAN, after terminal devices access the network through Port B, they will have access to the same resources as those accessing the network through Port A do, which brings security issues. To provide user access and ensure data security in the meantime, the MAC-based VLAN technology is developed.

MAC-based VLANs group VLAN members by MAC address. With MAC-based VLAN configured, the device adds a VLAN tag to an untagged frame according to its source MAC address. MAC-based VLANs are mostly used in conjunction with security technologies such as 802.1X to provide secure, flexible network access for terminal devices.

Web Interface

To configure MAC address-based VLAN configuration in the web interface:

1. Click VLC, MAC-based VLAN configuration and add new entry.
2. Specify the MAC address and VLAN ID.
3. Click Apply.

Figure 3-15.1: The MAC-based VLAN Membership Configuration

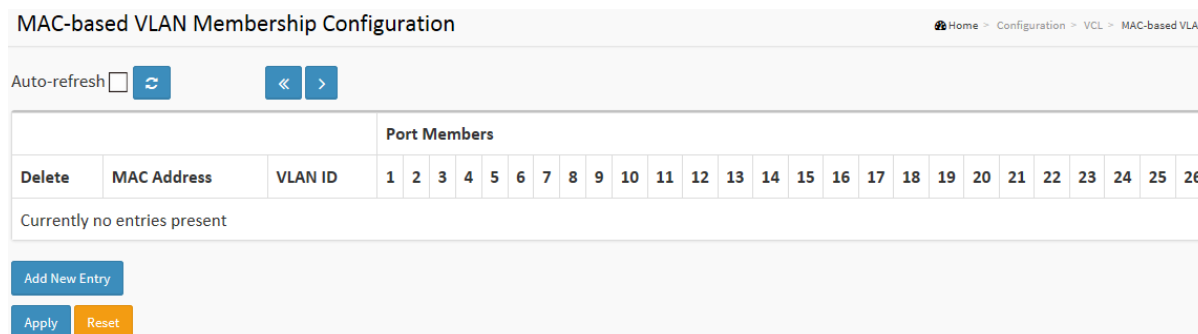

			Port Members																									
Delete	MAC Address	VLAN ID	1	2	3	4	5	6	7	8	9	10	11	12	13	14	15	16	17	18	19	20	21	22	23	24	25	26
Currently no entries present																												

Parameter description:

- **Delete :**
To delete a MAC-based VLAN entry, check this box and press save. The entry will be deleted on the selected switch in the stack.
- **MAC Address :**
Indicates the MAC address.
- **VLAN ID :**

Indicates the VLAN ID.

- **Port Members :**

A row of check boxes for each port is displayed for each MAC-based VLAN entry. To include a port in a MAC-based VLAN, check the box. To remove or exclude the port from the MAC-based VLAN, make sure the box is unchecked. By default, no ports are members, and all boxes are unchecked.

- **Adding a New MAC-based VLAN**

Click to add a new MAC-based VLAN entry. An empty row is added to the table, and the MAC-based VLAN entry can be configured as needed. Any unicast MAC address can be configured for the MAC-based VLAN entry. No broadcast or multicast MAC addresses are allowed. Legal values for a VLAN ID are 1 through 4095.

The MAC-based VLAN entry is enabled on the selected stack switch unit when you click on "Save". A MAC-based VLAN without any port members on any stack unit will be deleted when you click "Save".

The button can be used to undo the addition of new MAC-based VLANs.

- **Buttons:**

Apply – Click to save changes.

Reset- Click to undo any changes made locally and revert to previously saved values.

3-15.2 Protocol -based VLAN

This section describe Protocol -based VLAN, The Switch support Protocol include Ethernet LLC SNAP Protocol,

LLC

The Logical Link Control (LLC) data communication protocol layer is the upper sub-layer of the Data Link Layer (which is itself layer 2, just above the Physical Layer) in the seven-layer OSI reference model. It provides multiplexing mechanisms that make it possible for several network protocols (IP, IPX, Decnet and Appletalk) to coexist within a multipoint network and to be transported over the same network media, and can also provide flow control and automatic repeat request (ARQ) error management mechanisms.

SNAP

The Subnetwork Access Protocol (SNAP) is a mechanism for multiplexing, on networks using IEEE 802.2 LLC, more protocols than can be distinguished by the 8-bit 802.2 Service Access Point (SAP) fields. SNAP supports identifying protocols by Ethernet type field values; it also supports vendor-private protocol identifier spaces. It is used with IEEE 802.3, IEEE 802.4, IEEE 802.5, IEEE 802.11 and other IEEE 802 physical network layers, as well as with non-IEEE 802 physical network layers such as FDDI that use 802.2 LLC.

3-15.2.1 Protocol to Group

This page allows you to add new protocols to Group Name (unique for each Group) mapping entries as well as allow you to see and delete already mapped entries for the selected stack switch unit switch.

Web Interface

To configure Protocol -based VLAN configuration in the web interface:

1. Click Protocol -based VLAN configuration and add new entry.
2. Specify the Ethernet LLC SNAP Protocol and Group Name.
3. Click Apply.

Figure 3-15.2.1: The Protocol to Group Mapping Table

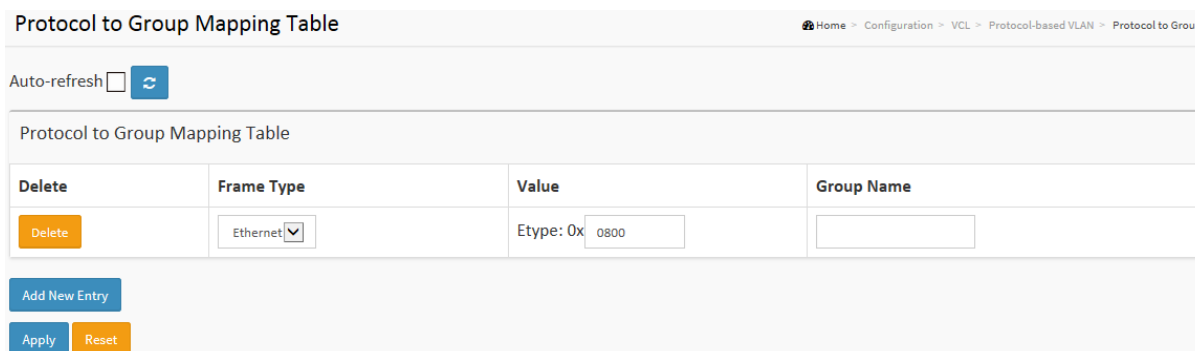

Protocol to Group Mapping Table

Auto-refresh 

Delete	Frame Type	Value	Group Name
<input type="checkbox"/>	Ethernet	Etype: 0x0800	

Parameter description:

- **Delete :**

To delete a Protocol to Group Name map entry, check this box. The entry will be deleted on the switch during the next Save.

- **Frame Type :**

Frame Type can have one of the following values:

1. Ethernet
2. LLC
3. SNAP



NOTE: On changing the Frame type field, valid value of the following text field will vary depending on the new frame type you selected.

- **Value :**

Valid value that can be entered in this text field depends on the option selected from the the preceding Frame Type selection menu.

Below is the criteria for three different Frame Types:

1. **For Ethernet:** Values in the text field when Ethernet is selected as a Frame Type is called etype. Valid values for etype ranges from 0x0600-0xffff
2. **For LLC:** Valid value in this case is comprised of two different sub-values.
 - a. DSAP: 1-byte long string (0x00-0xff)
 - b. SSAP: 1-byte long string (0x00-0xff)
3. **For SNAP:** Valid value in this case also is comprised of two different sub-values.
 - a. OUI: OUI (Organizationally Unique Identifier) is value in format of xx-xx-xx where each pair (xx) in string is a hexadecimal value ranges from 0x00-0xff.
 - b. PID: If the OUI is hexadecimal 000000, the protocol ID is the Ethernet type (EtherType) field value for the protocol running on top of SNAP; if the OUI is an OUI for a particular organization, the protocol ID is a value assigned by that organization to the protocol running on top of SNAP.
In other words, if value of OUI field is 00-00-00 then value of PID will be etype (0x0600-0xffff) and if value of OUI is other than 00-00-00 then valid value of PID will be any value from 0x0000 to 0xffff.

- **Group Name :**

A valid Group Name is a unique 16-character long string for every entry which consists of a combination of alphabets (a-z or A-Z) and integers(0-9).



NOTE: Special character and underscore(_) are not allowed.

- **Adding a New Group to VLAN mapping entry :**

Click to add a new entry in mapping table. An empty row is added to the table; Frame Type, Value and the Group Name can be configured as needed.

The button can be used to undo the addition of new entry.

- **Buttons:**

Apply – Click to save changes.

Reset- Click to undo any changes made locally and revert to previously saved values.

- **Upper right icon (Refresh):**

You can click them for refresh the Protocol Group Mapping information by manual.

3-15.2.2 Group to VLAN

This section allows you to map a already configured Group Name to a VLAN for the selected stack switch unit switch .

Web Interface

To Display Group Name to VLAN mapping table configured in the web interface:

1. Click Group Name VLAN configuration and add new entry.
2. Specify the Group Name and VLAN ID.
3. Click Apply.

Figure 3-15.2.2: The Group Name of VLAN Mapping Table

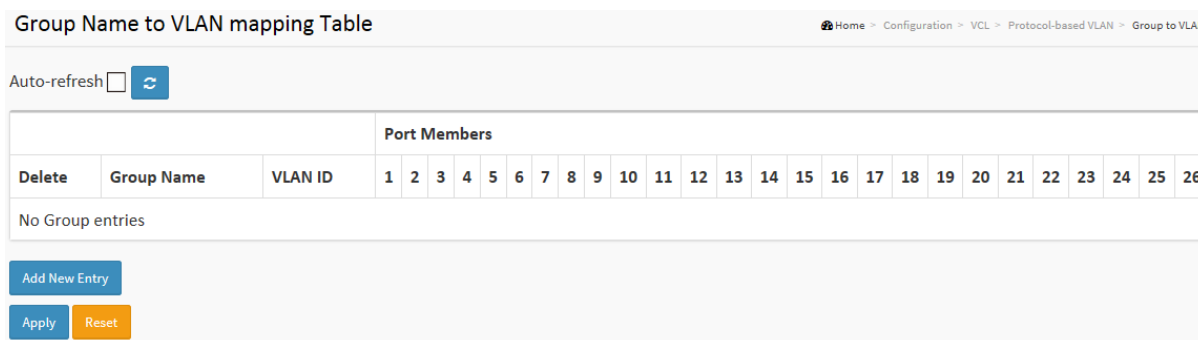

Delete	Group Name	VLAN ID	Port Members																									
			1	2	3	4	5	6	7	8	9	10	11	12	13	14	15	16	17	18	19	20	21	22	23	24	25	26
No Group entries																												

Parameter description:

- **Delete :**

To delete a Group Name to VLAN map entry, check this box. The entry will be deleted on the switch during the next Save

- **Group Name :**

A valid Group Name is a string of atmost 16 characters which consists of a combination of alphabets (a-z or A-Z) and integers(0-9), no special character is allowed. whichever Group name you try map to a VLAN must be present in Protocol to Group mapping table and must not be preused by any other existing mapping entry on this page.

- **VLAN ID :**

Indicates the ID to which Group Name will be mapped. A valid VLAN ID ranges from 1-4095.

- **Port Members :**

A row of check boxes for each port is displayed for each Group Name to VLAN ID mapping. To include a port in a mapping, check the box. To remove or exclude the port from the mapping, make sure the box is unchecked. By default, no ports are members, and all boxes are unchecked.

- **Adding a New Group to VLAN mapping entry :**

Click to add a new entry in mapping table. An empty row is added to the table, the Group Name, VLAN ID and port members can be configured as needed. Legal values for a VLAN ID are 1 through 4095. The button can be used to undo the addition of new entry.

- **Buttons:**

Apply – Click to save changes.

Reset- Click to undo any changes made locally and revert to previously saved values.

- **Auto-refresh :**

To evoke the auto-refresh icon then the device will refresh the information automatically.

- **Upper right icon (Refresh):**

You can click them for refresh the Protocol Group Mapping information by manual.

3-15.3 IP Subnet-based VLAN

The IP subnet-based VLAN entries can be configured here. This page allows for adding, updating and deleting IP subnet-based VLAN entries and assigning the entries to different ports. This page shows only static entries.

Web Interface

To Display IP subnet-based VLAN Membership to configured in the web interface:

1. Click VCL, Group Name VLAN configuration and add new entry.
2. Specify the VCE ID, IP Address, Mask Length, VLAN ID and select Port Members.
3. Click Apply.

Figure 2-15.3: IP Subnet-based VLAN Membership Configuration

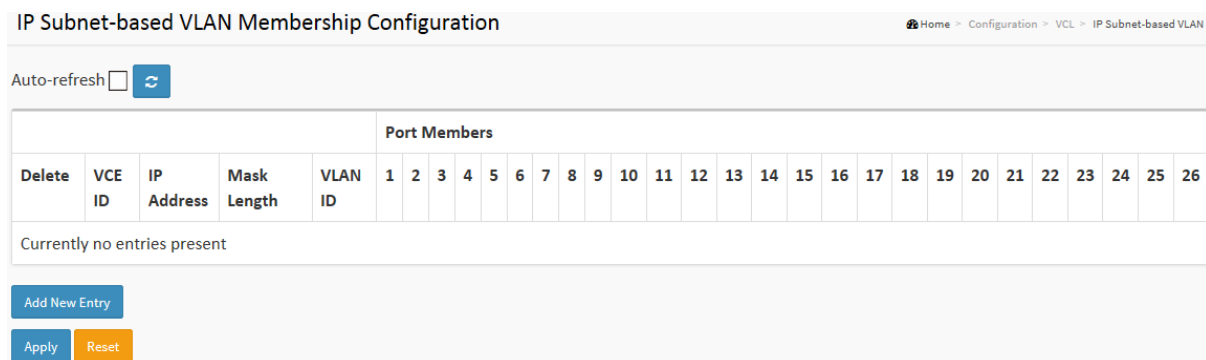

Delete	VCE ID	IP Address	Mask Length	VLAN ID	Port Members																									
					1	2	3	4	5	6	7	8	9	10	11	12	13	14	15	16	17	18	19	20	21	22	23	24	25	26
Currently no entries present																														

Parameter description:

- **Delete**

To delete a IP subnet-based VLAN entry, check this box and press save. The entry will be deleted on the selected switch in the stack.

- **VCE ID**

Indicates the index of the entry. It is user configurable. It's value ranges from 0-128. If a VCE ID is 0, application will auto-generate the VCE ID for that entry. Deletion and lookup of IP subnet-based VLAN are based on VCE ID.

- **IP Address**

Indicates the IP address.

- **Mask Length**

Indicates the network mask length.

- **VLAN ID**

Indicates the VLAN ID. VLAN ID can be changed for the existing entries.

- **Port Members**

A row of check boxes for each port is displayed for each IP subnet-based VLAN entry. To include a port in a IP subnet-based VLAN, check the box. To remove or exclude the port from the IP subnet-based VLAN, make sure the box is unchecked. By default, no ports are members, and all boxes are unchecked.

- **Adding a New IP subnet-based VLAN**

Click "Add New Entry" to add a new IP subnet-based VLAN entry. An empty row is added to

the table, and the IP subnet-based VLAN entry can be configured as needed. Any IP address/mask can be configured for the IP subnet-based VLAN entry. Legal values for a VLAN ID are 1 through 4095.

The IP subnet-based VLAN entry is enabled on the selected stack switch unit when you click on "Save". The "Delete" button can be used to undo the addition of new IP subnet-based VLANs. The maximum possible IP subnet-based VLAN entries are limited to 128.

3-16 VOICE VLAN

Voice VLAN is VLAN configured specially for voice traffic. By adding the ports with voice devices attached to voice VLAN, we can perform QoS-related configuration for voice data, ensuring the transmission priority of voice traffic and voice quality.

3-16.1 Configuration

The Voice VLAN feature enables voice traffic forwarding on the Voice VLAN, then the switch can classify and schedule network traffic. It is recommended that there be two VLANs on a port - one for voice, one for data. Before connecting the IP device to the switch, the IP phone should configure the voice VLAN ID correctly. It should be configured through its own GUI.

Web Interface

To configure Voice VLAN in the web interface:

1. Select "Enabled" in the Voice VLAN Configuration.
2. Specify VLAN ID Aging Time Traffic Class.
3. Specify (Port Mode, Security, Discovery Protocol) in the Port Configuration
4. Click Apply.

Figure 3-16.1: The Voice VLAN Configuration

Voice VLAN Configuration
Home > Configuration > Voice VLAN > Configuration

Voice VLAN Configuration

Mode	Disabled <input type="button" value="v"/>
VLAN ID	1000
Aging Time	86400 seconds
Traffic	7 (High) <input type="button" value="v"/>

Port Configuration

Port	Mode	Security	Discovery Protocol
*	<> <input type="button" value="v"/>	<> <input type="button" value="v"/>	<> <input type="button" value="v"/>
1	Disabled <input type="button" value="v"/>	Disabled <input type="button" value="v"/>	OUI <input type="button" value="v"/>
2	Disabled <input type="button" value="v"/>	Disabled <input type="button" value="v"/>	OUI <input type="button" value="v"/>
23	Disabled <input type="button" value="v"/>	Disabled <input type="button" value="v"/>	OUI <input type="button" value="v"/>
24	Disabled <input type="button" value="v"/>	Disabled <input type="button" value="v"/>	OUI <input type="button" value="v"/>
25	Disabled <input type="button" value="v"/>	Disabled <input type="button" value="v"/>	OUI <input type="button" value="v"/>
26	Disabled <input type="button" value="v"/>	Disabled <input type="button" value="v"/>	OUI <input type="button" value="v"/>

Apply
Reset

Parameter description:

- **Mode :**

Indicates the Voice VLAN mode operation. We must disable MSTP feature before we enable Voice VLAN. It can avoid the conflict of ingress filtering. Possible modes are:

Enabled: Enable Voice VLAN mode operation.

Disabled: Disable Voice VLAN mode operation.

- **VLAN ID :**

Indicates the Voice VLAN ID. It should be a unique VLAN ID in the system and cannot equal each port PVID. It is a conflict in configuration if the value equals management VID, MVR VID, PVID etc. The allowed range is 1 to 4095.

- **Aging Time :**

Indicates the Voice VLAN secure learning aging time. The allowed range is 10 to 10000000 seconds. It is used when security mode or auto detect mode is enabled. In other cases, it will be based on hardware aging time. The actual aging time will be situated between the [age_time; 2 * age_time] interval.

- **Traffic Class :**

Indicates the Voice VLAN traffic class. All traffic on the Voice VLAN will apply this class.

- **Port Mode :**

Indicates the Voice VLAN port mode.

When the port mode isn't equal disabled, we must disable MSTP feature before we enable Voice VLAN. It can avoid the conflict of ingress filtering.

Possible port modes are:

Disabled: Disjoin from Voice VLAN.

Auto: Enable auto detect mode. It detects whether there is VoIP phone attached to the specific port and configures the Voice VLAN members automatically.

Forced: Force join to Voice VLAN.

- **Port Security :**

Indicates the Voice VLAN port security mode. When the function is enabled, all non-telephonic MAC addresses in the Voice VLAN will be blocked for 10 seconds. Possible port modes are:

Enabled: Enable Voice VLAN security mode operation.

Disabled: Disable Voice VLAN security mode operation.

- **Port Discovery Protocol :**

Indicates the Voice VLAN port discovery protocol. It will only work when auto detect mode is enabled. We should enable LLDP feature before configuring discovery protocol to "LLDP" or "Both". Changing the discovery protocol to "OUI" or "LLDP" will restart auto detect process. Possible discovery protocols are:

OUI: Detect telephony device by OUI address.

LLDP: Detect telephony device by LLDP.

Both: Both OUI and LLDP.

- **Buttons:**

Apply – Click to save changes.

Reset- Click to undo any changes made locally and revert to previously saved values.

3-16.2 OUI

The section describes to Configure VOICE VLAN OUI table . The maximum entry number is 16. Modifying the OUI table will restart auto detection of OUI process.

Web Interface

To configure Voice VLAN OUI Table in the web interface:

1. Select "Add new entry" ,"Delete" in the Voice VLAN OUI table..
2. Specify Telephony OUI, Description..
3. Click Apply.

Figure 2-18.2: The Voice VLAN OUI Table

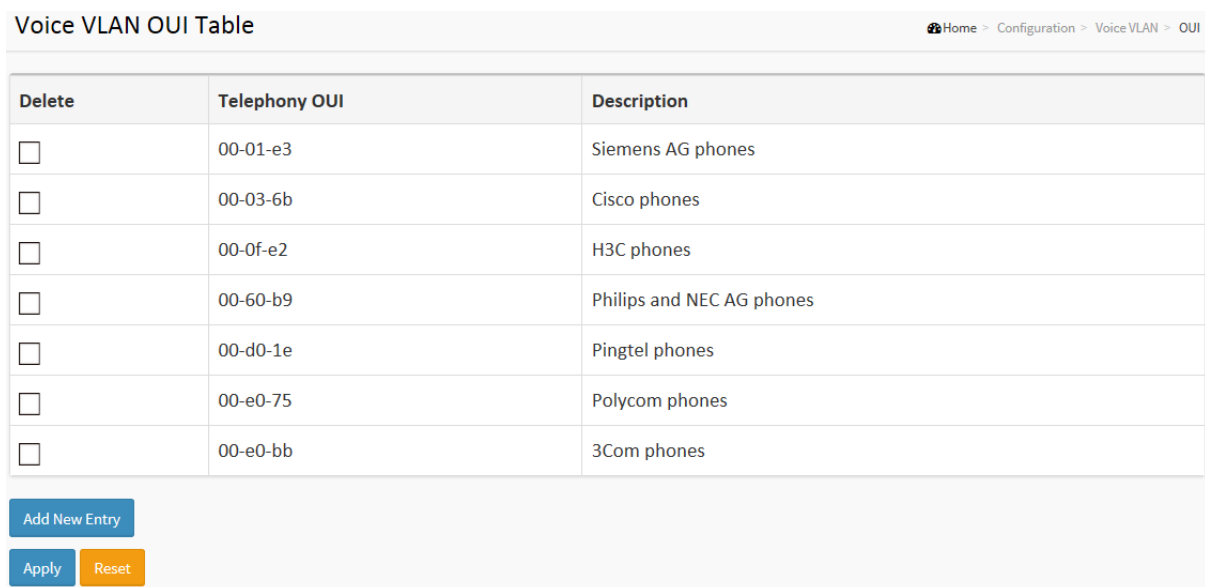

Delete	Telephony OUI	Description
<input type="checkbox"/>	00-01-e3	Siemens AG phones
<input type="checkbox"/>	00-03-6b	Cisco phones
<input type="checkbox"/>	00-0f-e2	H3C phones
<input type="checkbox"/>	00-60-b9	Philips and NEC AG phones
<input type="checkbox"/>	00-d0-1e	Pingtel phones
<input type="checkbox"/>	00-e0-75	Polycom phones
<input type="checkbox"/>	00-e0-bb	3Com phones

Buttons: Add New Entry, Apply, Reset

Parameter description:

- **Delete :**
Check to delete the entry. It will be deleted during the next save.
- **Telephony OUI :**
A telephony OUI address is a globally unique identifier assigned to a vendor by IEEE. It must be 6 characters long and the input format is "xx-xx-xx" (x is a hexadecimal digit).
- **Description :**
The description of OUI address. Normally, it describes which vendor telephony device it belongs to. The allowed string length is 0 to 32.
- **Add New entry :**
Click to add a new entry in Voice VLAN OUI table. An empty row is added to the table, the Telephony OUI, Description.
- **Buttons:**
Apply – Click to save changes.
Reset- Click to undo any changes made locally and revert to previously saved values.

3-17 QoS

The switch support four QoS queues per port with strict or weighted fair queuing scheduling. It supports QoS Control Lists (QCL) for advance programmable QoS classification, based on IEEE 802.1p, Ethertype, VID, IPv4/IPv6 DSCP and UDP/TCP ports and ranges.

High flexibility in the classification of incoming frames to a QoS class. The QoS classification looks for information up to Layer 4, including IPv4 and IPv6 DSCP, IPv4 TCP/UDP port numbers, and user priority of tagged frames. This QoS classification mechanism is implemented in a QoS control list (QCL). The QoS class assigned to a frame is used throughout the device for providing queuing, scheduling, and congestion control guarantees to the frame according to what was configured for that specific QoS class.

The switch support advanced memory control mechanisms providing excellent performance of all QoS classes under any traffic scenario, including jumbo frame. A super priority queue with dedicated memory and strict highest priority in the arbitration. The ingress super priority queue allows traffic recognized as CPU traffic to be received and queued for transmission to the CPU even when all the QoS class queues are congested.

3-17.1 Port Classification

The section allows you to configure the basic QoS Ingress Classification settings for all switch ports. and the settings relate to the currently selected stack unit, as reflected by the page header.

Web Interface

To configure the QoS Port Classification parameters in the web interface:

1. Click Configuration, QoS, Port Classification
2. Scroll to select QoS class, DP Level, PCP and DEI parameters
3. Click the save to save the setting
4. If you want to cancel the setting then you need to click the Reset button.
It will revert to previously saved values

Figure 3-17.1: The QoS Configuration

QoS Ingress Port Classification Home > Configuration > QoS > Port Classification

Port	CoS	DPL	PCP	DEI	Tag Class.	DSCP Based	Address Mode
*	<input type="text" value="<"/>	<input type="text" value="<"/>	<input type="text" value="<"/>	<input type="text" value="<"/>		<input type="checkbox"/>	<input type="text" value="<"/>
1	<input type="text" value="0"/>	<input type="text" value="0"/>	<input type="text" value="0"/>	<input type="text" value="0"/>	Disabled	<input type="checkbox"/>	Source <input type="text" value=""/>
2	<input type="text" value="0"/>	<input type="text" value="0"/>	<input type="text" value="0"/>	<input type="text" value="0"/>	Disabled	<input type="checkbox"/>	Source <input type="text" value=""/>
3	<input type="text" value="0"/>	<input type="text" value="0"/>	<input type="text" value="0"/>	<input type="text" value="0"/>	Disabled	<input type="checkbox"/>	Source <input type="text" value=""/>
4	<input type="text" value="0"/>	<input type="text" value="0"/>	<input type="text" value="0"/>	<input type="text" value="0"/>	Disabled	<input type="checkbox"/>	Source <input type="text" value=""/>
23	<input type="text" value="0"/>	<input type="text" value="0"/>	<input type="text" value="0"/>	<input type="text" value="0"/>	Disabled	<input type="checkbox"/>	Source <input type="text" value=""/>
24	<input type="text" value="0"/>	<input type="text" value="0"/>	<input type="text" value="0"/>	<input type="text" value="0"/>	Disabled	<input type="checkbox"/>	Source <input type="text" value=""/>
25	<input type="text" value="0"/>	<input type="text" value="0"/>	<input type="text" value="0"/>	<input type="text" value="0"/>	Disabled	<input type="checkbox"/>	Source <input type="text" value=""/>
26	<input type="text" value="0"/>	<input type="text" value="0"/>	<input type="text" value="0"/>	<input type="text" value="0"/>	Disabled	<input type="checkbox"/>	Source <input type="text" value=""/>

Parameter description:

- **Port :**

The port number for which the configuration below applies.

- **CoS :**

Controls the default class of service.

All frames are classified to a CoS. There is a one to one mapping between CoS, queue and priority. A CoS of 0 (zero) has the lowest priority.

If the port is VLAN aware, the frame is tagged and Tag Class. is enabled, then the frame is classified to a CoS that is mapped from the PCP and DEI value in the tag. Otherwise the frame is classified to the default CoS.

The classified CoS can be overruled by a QCL entry.

Note: If the default CoS has been dynamically changed, then the actual default CoS is shown in parentheses after the configured default CoS.

- **DPL :**

Controls the default drop precedence level.

All frames are classified to a drop precedence level.

If the port is VLAN aware, the frame is tagged and Tag Class. is enabled, then the frame is classified to a DPL that is mapped from the PCP and DEI value in the tag. Otherwise the frame is classified to the default DPL.

The classified DPL can be overruled by a QCL entry.

- **PCP :**

Controls the default PCP value.

All frames are classified to a PCP value.

If the port is VLAN aware and the frame is tagged, then the frame is classified to the PCP value in the tag. Otherwise the frame is classified to the default PCP value.

- **DEI :**

Controls the default DEI value.

All frames are classified to a DEI value.

If the port is VLAN aware and the frame is tagged, then the frame is classified to the DEI value in the tag. Otherwise the frame is classified to the default DEI value.

- **Tag Class. :**

Shows the classification mode for tagged frames on this port.

Disabled: Use default QoS class and DP level for tagged frames.

Enabled: Use mapped versions of PCP and DEI for tagged frames.

Click on the mode in order to configure the mode and/or mapping.



NOTE: This setting has no effect if the port is VLAN unaware. Tagged frames received on VLAN unaware ports are always classified to the default CoS and DPL.

- **DSCP Based :**

Click to Enable DSCP Based QoS Ingress Port Classification.

- **Address Mode :**

The IP/MAC address mode specifying whether the QCL classification must be based on source (SMAC/SIP) or destination (DMAC/DIP) addresses on this port. The allowed values are:

Source: Enable SMAC/SIP matching.

Destination: Enable DMAC/DIP matching.

- **Buttons:**

Apply – Click to save changes.

Reset- Click to undo any changes made locally and revert to previously saved values.

3-17.2 Port Policing

This section provides an overview of f QoS Ingress Port Policers for all switch ports The Port Policing is useful in constraining traffic flows and marking frames above specific rates. Policing is primarily useful for data flows and voice or video flows because voice and video usually maintains a steady rate of traffic

Web Interface

To display the QoS Port Schedulers in the web interface:

1. Click Configuration, QoS, Port Policing
2. Evoke which port need to enable the QoS Ingress Port Policers and type the Rate limit condition.
3. Scroll to select the Rate limit Unit with kbps, Mbps, fps and kfps.
4. Click Apply to save the configuration.

Figure 3-17.2: The QoS Ingress Port Policers Configuration

QoS Ingress Port Policers Home > Configuration > QoS > Port Policing

Port	Enabled	Rate	Unit	Flow Control
*	<input type="checkbox"/>	500	<> ▼	<input type="checkbox"/>
1	<input type="checkbox"/>	500	kbps ▼	<input type="checkbox"/>
2	<input type="checkbox"/>	500	kbps ▼	<input type="checkbox"/>
3	<input type="checkbox"/>	500	kbps ▼	<input type="checkbox"/>
23	<input type="checkbox"/>	500	kbps ▼	<input type="checkbox"/>
24	<input type="checkbox"/>	500	kbps ▼	<input type="checkbox"/>
25	<input type="checkbox"/>	500	kbps ▼	<input type="checkbox"/>
26	<input type="checkbox"/>	500	kbps ▼	<input type="checkbox"/>

Apply Reset

Parameter description:

- **Port :**
The logical port for the settings contained in the same row. Click on the port number in order to configure the schedulers.
- **Enabled :**
To evoke which Port you need to enable the QoS Ingress Port Policers function.
- **Rate :**
To set the Rate limit value for this port, the default is 500.
- **Unit :**
To scroll to select what unit of rate includes kbps, Mbps, fps and kfps. The default is kbps.
- **Flow Control :**
If flow control is enabled and the port is in flow control mode, then pause frames are sent instead of discarding frames.
- **Buttons:**

Apply – Click to save changes.

Reset- Click to undo any changes made locally and revert to previously saved values.

3-17.4 Port Schedulers

This section provides an overview of QoS Egress Port Schedulers for all switch ports. and the ports belong to the currently selected stack unit, as reflected by the page header.

Web Interface

To display the QoS Port Schedulers in the web interface:

1. Click Configuration, QoS, Port Schedulers
2. Display the QoS Egress Port Schedulers

Figure 3-17.4: The QoS Egress Port Schedules

QoS Egress Port Schedulers Home > Configuration > QoS > Port Scheduler

Port	Mode	Q0	Q1	Q2	Q3	Q4	Q5
1	Strict Priority	-	-	-	-	-	-
2	Strict Priority	-	-	-	-	-	-
3	Strict Priority	-	-	-	-	-	-

Click the Port index to set the QoS Egress Port Schedulers

QoS Egress Port Scheduler and Shapers Port 1 Home > Configuration > QoS > Port Scheduler

Port: Port 1

Scheduler Mode: Strict Priority

Queue Shaper

Queue	Enable	Rate	Unit	Excess
*	<input type="checkbox"/>	500	<>	<input type="checkbox"/>
0	<input type="checkbox"/>	500	kbps	<input type="checkbox"/>
1	<input type="checkbox"/>	500	kbps	<input type="checkbox"/>
2	<input type="checkbox"/>	500	kbps	<input type="checkbox"/>
3	<input type="checkbox"/>	500	kbps	<input type="checkbox"/>
4	<input type="checkbox"/>	500	kbps	<input type="checkbox"/>
5	<input type="checkbox"/>	500	kbps	<input type="checkbox"/>
6	<input type="checkbox"/>	500	kbps	<input type="checkbox"/>
7	<input type="checkbox"/>	500	kbps	<input type="checkbox"/>

Port Shaper

Enable	Rate	Unit
<input type="checkbox"/>	500	kbps

Port	Port 1 <input type="button" value="v"/>
Scheduler Mode	Weighted <input type="button" value="v"/>

Queue Shaper					Queue Scheduler	
Queue	Enable	Rate	Unit	Excess	Weight	Percent
*	<input type="checkbox"/>	500	<> <input type="button" value="v"/>	<input type="checkbox"/>	17	
0	<input type="checkbox"/>	500	kbps <input type="button" value="v"/>	<input type="checkbox"/>	17	
1	<input type="checkbox"/>	500	kbps <input type="button" value="v"/>	<input type="checkbox"/>	17	
2	<input type="checkbox"/>	500	kbps <input type="button" value="v"/>	<input type="checkbox"/>	17	
3	<input type="checkbox"/>	500	kbps <input type="button" value="v"/>	<input type="checkbox"/>	17	17%
4	<input type="checkbox"/>	500	kbps <input type="button" value="v"/>	<input type="checkbox"/>	17	17%
5	<input type="checkbox"/>	500	kbps <input type="button" value="v"/>	<input type="checkbox"/>	17	17%
6	<input type="checkbox"/>	500	kbps <input type="button" value="v"/>	<input type="checkbox"/>		
7	<input type="checkbox"/>	500	kbps <input type="button" value="v"/>	<input type="checkbox"/>		

If you select the scheduler mode with wighted then the screen will change as the figure.

Port Shaper		
Enable	Rate	Unit
<input type="checkbox"/>	500	kbps <input type="button" value="v"/>

Parameter description:

- Port :**
 The logical port for the settings contained in the same row. Click on the port number in order to configure the schedulers.
- Mode :**
 Shows the scheduling mode for this port.
- Weight (Qn) :**
 Shows the weight for this queue and port.
- Scheduler Mode :**
 Controls whether the scheduler mode is "Strict Priority" or "Weighted" on this switch port.
- Queue Shaper Enable :**
 Controls whether the queue shaper is enabled for this queue on this switch port.
- Queue Shaper Rate :**
 Controls the rate for the queue shaper. The default value is ?. This value is restricted to ?-1000000 when the "Unit" is "kbps", and it is restricted to 1-? when the "Unit" is "Mbps".
- Queue Shaper Unit :**
 Controls the unit of measure for the queue shaper rate as "kbps" or "Mbps". The default value is "kbps".
- Queue Shaper Excess :**

Controls whether the queue is allowed to use excess bandwidth.

- **Queue Scheduler Weight :**

Controls the weight for this queue. The default value is "17". This value is restricted to 1-100. This parameter is only shown if "Scheduler Mode" is set to "Weighted".

- **Queue Scheduler Percent :**

Shows the weight in percent for this queue. This parameter is only shown if "Scheduler Mode" is set to "Weighted"

- **Port Shaper Enable :**

Controls whether the port shaper is enabled for this switch port.

- **Port Shaper Rate :**

Controls the rate for the port shaper. The default value is ?. This value is restricted to ?-1000000 when the "Unit" is "kbps", and it is restricted to 1-? when the "Unit" is "Mbps".

- **Port Shaper Unit :**

Controls the unit of measure for the port shaper rate as "kbps" or "Mbps". The default value is "kbps".

- **Buttons:**

Apply – Click to save changes.

Reset- Click to undo any changes made locally and revert to previously saved values.

3-17.5 Port Shaping

This section provides an overview of QoS Egress Port Shapers for all switch ports. Others the user could get all detail information of the ports belong to the currently selected stack unit, as reflected by the page header.

Web Interface

To display the QoS Port Shapers in the web interface:

1. Click Configuration, QoS, Port Shapers
2. Display the QoS Egress Port Shapers

Figure 3-17.5: The QoS Egress Port Shapers

QoS Egress Port Shapers Home > Configuration > QoS > Port Shaping

Port	Shapers							Port	
	Q0	Q1	Q2	Q3	Q4	Q5	Q6		Q7
1	disabled	disabled	disabled	disabled	disabled	disabled	disabled	disabled	disabled
2	disabled	disabled	disabled	disabled	disabled	disabled	disabled	disabled	disabled
3	disabled	disabled	disabled	disabled	disabled	disabled	disabled	disabled	disabled

Click the Port index to set the QoS Egress Port Shapers

QoS Egress Port Scheduler and Shapers Port 1 Home > Configuration > QoS > Port Scheduler

Port: Port 1

Scheduler Mode: Strict Priority

Queue Shaper

Queue	Enable	Rate	Unit	Excess
*	<input type="checkbox"/>	<input type="text" value="500"/>	<> ▾	<input type="checkbox"/>
0	<input type="checkbox"/>	<input type="text" value="500"/>	kbps ▾	<input type="checkbox"/>
1	<input type="checkbox"/>	<input type="text" value="500"/>	kbps ▾	<input type="checkbox"/>
2	<input type="checkbox"/>	<input type="text" value="500"/>	kbps ▾	<input type="checkbox"/>
3	<input type="checkbox"/>	<input type="text" value="500"/>	kbps ▾	<input type="checkbox"/>
4	<input type="checkbox"/>	<input type="text" value="500"/>	kbps ▾	<input type="checkbox"/>
5	<input type="checkbox"/>	<input type="text" value="500"/>	kbps ▾	<input type="checkbox"/>
6	<input type="checkbox"/>	<input type="text" value="500"/>	kbps ▾	<input type="checkbox"/>
7	<input type="checkbox"/>	<input type="text" value="500"/>	kbps ▾	<input type="checkbox"/>

Port Shaper

Enable	Rate	Unit
<input type="checkbox"/>	<input type="text" value="500"/>	kbps ▾

Apply
Reset
Cancel

Port	Port 1 <input type="button" value="v"/>
Scheduler Mode	Weighted <input type="button" value="v"/>

Queue Shaper					Queue Scheduler	
Queue	Enable	Rate	Unit	Exces		
*	<input type="checkbox"/>	500	<> <input type="button" value="v"/>	<input type="checkbox"/>		
0	<input type="checkbox"/>	500	kbps <input type="button" value="v"/>	<input type="checkbox"/>		
1	<input type="checkbox"/>	500	kbps <input type="button" value="v"/>	<input type="checkbox"/>	17	17%
2	<input type="checkbox"/>	500	kbps <input type="button" value="v"/>	<input type="checkbox"/>	17	17%
3	<input type="checkbox"/>	500	kbps <input type="button" value="v"/>	<input type="checkbox"/>	17	17%
4	<input type="checkbox"/>	500	kbps <input type="button" value="v"/>	<input type="checkbox"/>	17	17%
5	<input type="checkbox"/>	500	kbps <input type="button" value="v"/>	<input type="checkbox"/>	17	17%
6	<input type="checkbox"/>	500	kbps <input type="button" value="v"/>	<input type="checkbox"/>		
7	<input type="checkbox"/>	500	kbps <input type="button" value="v"/>	<input type="checkbox"/>		

If you select the scheduler mode with wighted then the screen will change as the figure.

Port Shaper		
Enable	Rate	Unit
<input type="checkbox"/>	500	kbps <input type="button" value="v"/>

Parameter description:

- Port :**

The logical port for the settings contained in the same row. Click on the port number in order to configure the shapers.
- Mode :**

Shows the scheduling mode for this port.
- Shapers (Qn) :**

Shows "disabled" or actual queue shaper rate - e.g. "800 Mbps".
- Scheduler Mode :**

Controls whether the scheduler mode is "Strict Priority" or "Weighted" on this switch port.
- Queue Shaper Enable :**

Controls whether the queue shaper is enabled for this queue on this switch port.
- Queue Shaper Rate :**

Controls the rate for the queue shaper. The default value is ?. This value is restricted to ?-1000000 when the "Unit" is "kbps", and it is restricted to 1-? when the "Unit" is "Mbps".
- Queue Shaper Unit :**

Controls the unit of measure for the queue shaper rate as "kbps" or "Mbps". The default value is "kbps".

- **Queue Shaper Excess :**
Controls whether the queue is allowed to use excess bandwidth.
- **Queue Scheduler Weight :**
Controls the weight for this queue. The default value is "17". This value is restricted to 1-100. This parameter is only shown if "Scheduler Mode" is set to "Weighted".
- **Queue Scheduler Percent :**
Shows the weight in percent for this queue. This parameter is only shown if "Scheduler Mode" is set to "Weighted"
- **Port Shaper Enable :**
Controls whether the port shaper is enabled for this switch port.
- **Port Shaper Rate :**
Controls the rate for the port shaper. The default value is ?. This value is restricted to ?-1000000 when the "Unit" is "kbps", and it is restricted to 1-? when the "Unit" is "Mbps".
- **Port Shaper Unit :**
Controls the unit of measure for the port shaper rate as "kbps" or "Mbps". The default value is "kbps".
- **Buttons:**
 - Apply** – Click to save changes.
 - Reset**- Click to undo any changes made locally and revert to previously saved values.

3-17.6 Port Tag Remarking

The Section provides user to get an overview of QoS Egress Port Tag Remarking for all switch ports. Others the ports belong to the currently selected stack unit, as reflected by the page header. .

Web Interface

To display the QoS Port Tag Remarking in the web interface:

1. Click Configuration, QoS, Port Tag Remarking

Figure 3-16.6: The Port Tag Remarking

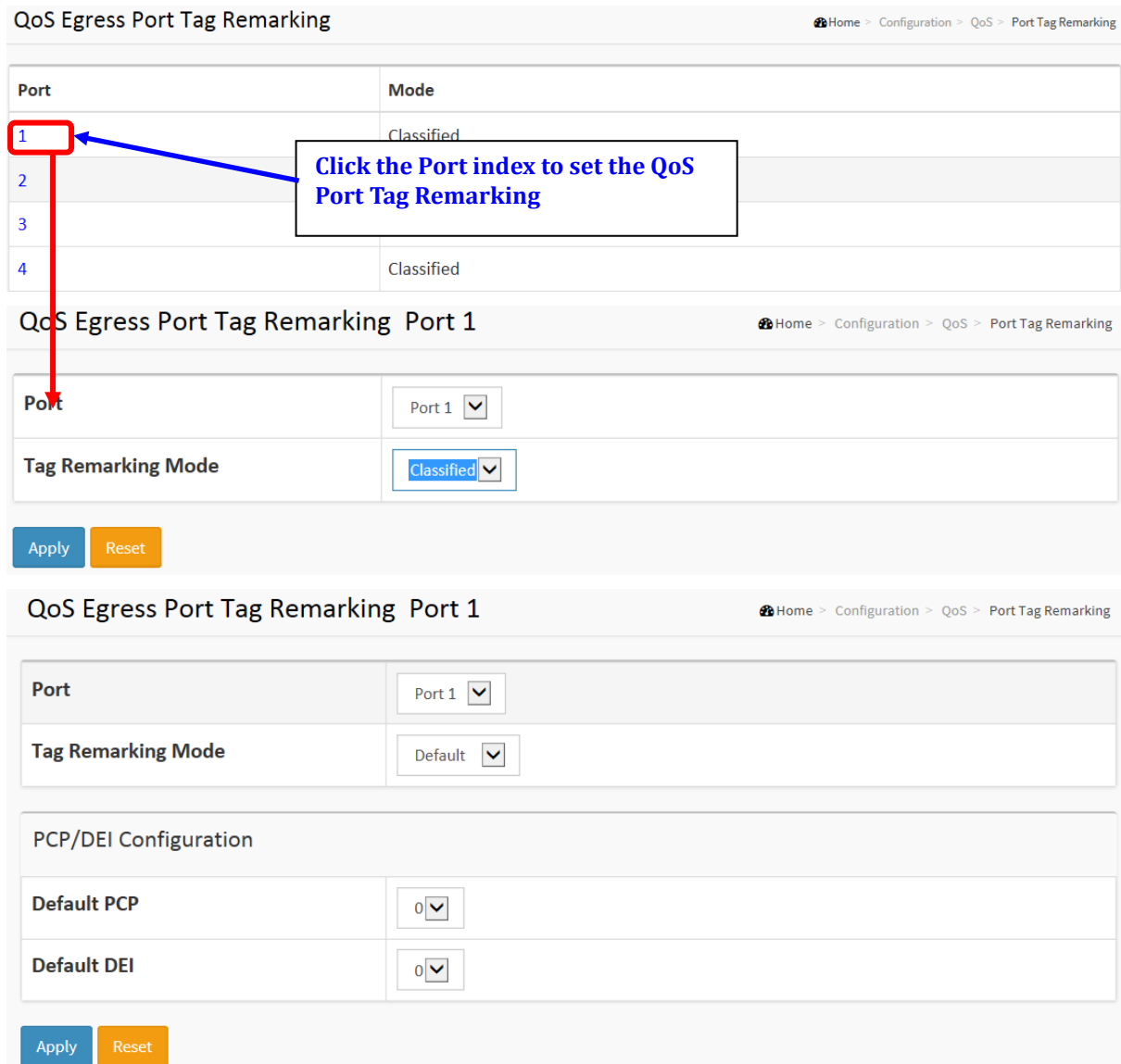

The screenshot illustrates the web interface for configuring QoS Egress Port Tag Remarking. It is divided into three main sections:

- QoS Egress Port Tag Remarking (Overview):** A table lists available ports and their modes.

Port	Mode
1	Classified
2	
3	
4	Classified

 A red box highlights the '1' in the first row, with a blue arrow pointing to it and a callout box that says "Click the Port index to set the QoS Port Tag Remarking".
- QoS Egress Port Tag Remarking Port 1 (Configuration):** A form for configuring Port 1.

Port	Port 1
Tag Remarking Mode	Classified

 Below the form are "Apply" and "Reset" buttons.
- QoS Egress Port Tag Remarking Port 1 (Detailed Configuration):** A more detailed configuration page for Port 1.

Port	Port 1
Tag Remarking Mode	Default

PCP/DEI Configuration

Default PCP	0
Default DEI	0

 Below this section are "Apply" and "Reset" buttons.

Port	Port 1 <input type="button" value="v"/>
Tag Remarking Mode	Mapped <input type="button" value="v"/>

(QoS class, DP level) to (PCP, DEI) Mapping

QoS class	DP level	PCP	DEI
*	*	<> <input type="button" value="v"/>	<> <input type="button" value="v"/>
0	0	1 <input type="button" value="v"/>	0 <input type="button" value="v"/>
0	1	1 <input type="button" value="v"/>	1 <input type="button" value="v"/>
1	0	0 <input type="button" value="v"/>	0 <input type="button" value="v"/>
1	1	0 <input type="button" value="v"/>	1 <input type="button" value="v"/>
2	0	2 <input type="button" value="v"/>	0 <input type="button" value="v"/>
2	1	2 <input type="button" value="v"/>	1 <input type="button" value="v"/>
3	0	3 <input type="button" value="v"/>	0 <input type="button" value="v"/>
3	1	3 <input type="button" value="v"/>	1 <input type="button" value="v"/>
4	0	4 <input type="button" value="v"/>	0 <input type="button" value="v"/>
4	1	4 <input type="button" value="v"/>	1 <input type="button" value="v"/>
5	0	5 <input type="button" value="v"/>	0 <input type="button" value="v"/>
5	1	5 <input type="button" value="v"/>	1 <input type="button" value="v"/>
6	0	6 <input type="button" value="v"/>	0 <input type="button" value="v"/>
6	1	6 <input type="button" value="v"/>	1 <input type="button" value="v"/>
7	0	7 <input type="button" value="v"/>	0 <input type="button" value="v"/>
7	1	7 <input type="button" value="v"/>	1 <input type="button" value="v"/>

Parameter description:

- **Mode :**

Controls the tag remarking mode for this port.

Classified: Use classified PCP/DEI values.

Default: Use default PCP/DEI values.

Mapped: Use mapped versions of QoS class and DP level.

- **PCP/DEI Configuration :**

Controls the default PCP and DEI values used when the mode is set to Default.

- **(QoS class, DP level) to (PCP, DEI) Mapping :**
Controls the mapping of the classified (QoS class, DP level) to (PCP, DEI) values when the mode is set to Mapped.
- **Buttons:**
 - Apply** – Click to save changes.
 - Reset**- Click to undo any changes made locally and revert to previously saved values.
 - Cancel** – Click to cancel the changes.

3-17.7 Port DSCP

The section will teach user to set the QoS Port DSCP configuration that was allowed you to configure the basic QoS Port DSCP Configuration settings for all switch ports. Others the settings relate to the currently selected stack unit, as reflected by the page header.

Web Interface

To configure the QoS Port DSCP parameters in the web interface:

1. Click Configuration, QoS, Port DSCP
2. Evoke to enable or disable the Ingress Translate and Scroll the Classify Parameter configuration
3. Scroll to select Egress Rewrite parameters
4. Click the save to save the setting
5. If you want to cancel the setting then you need to click the Reset button. It will revert to previously saved values

Figure 3-16.7: The QoS Port DSCP Configuration

QoS Port DSCP Configuration Home > Configuration > QoS > Port DSCP

Port	Ingress		Egress
	Translate	Classify	Rewrite
*	<input type="checkbox"/>	<> ▼	<> ▼
1	<input type="checkbox"/>	Disable ▼	Disable ▼
2	<input type="checkbox"/>	Disable ▼	Disable ▼
23	<input type="checkbox"/>	Disable ▼	Disable ▼
24	<input type="checkbox"/>	Disable ▼	Disable ▼
25	<input type="checkbox"/>	Disable ▼	Disable ▼
26	<input type="checkbox"/>	Disable ▼	Disable ▼

Parameter description:

- **Port :**

The Port column shows the list of ports for which you can configure dscp ingress and egress settings.

- **Ingress :**

In Ingress settings you can change ingress translation and classification settings for individual ports.

There are two configuration parameters available in Ingress:

1. **Translate :** To Enable the Ingress Translation click the checkbox
2. **Classify:** Classification for a port have 4 different values
 - Disable: No Ingress DSCP Classification.
 - DSCP=0: Classify if incoming (or translated if enabled) DSCP is 0.
 - Selected: Classify only selected DSCP for which classification is enabled as specified in DSCP Translation window for the specific DSCP.
 - All: Classify all DSCP.

- **Egress :**

Port Egress Rewriting can be one of below parameters

- Disable: No Egress rewrite.
- Enable: Rewrite enable without remapped.
- Remap: DSCP from analyzer is remapped and frame is remarked with remapped DSCP value.

- **Buttons:**

Apply – Click to save changes.

Reset- Click to undo any changes made locally and revert to previously saved values.

- **Auto-refresh :**

To evoke the auto-refresh icon then the device will refresh the information automatically.

- **Upper right icon (Refresh):**

You can click them for refresh the QoS Port DSCP information by manual.

3-17.8 DSCP-Based QoS

The section will teach user to configure the DSCP-Based QoS mode that This page allows you to configure the basic QoS DSCP based QoS Ingress Classification settings for all switches.

Web Interface

To configure the DSCP –Based QoS Ingress Classification parameters in the web interface:

1. Click Configuration, QoS, DSCP-Based QoS
2. Evoke to enable or disable the DSCP for Trust
3. Scroll to select QoS Class and DPL parameters
4. Click the save to save the setting
5. If you want to cancel the setting then you need to click the Reset button. It will revert to previously saved values

Figure 3-17.8: The DSCP-Based QoS Ingress Classification Configuration

DSCP-Based QoS Ingress Classification Home > Configuration > QoS > DSCP-Based QoS

DSCP	Trust	QoS Class	DPL
*	<input type="checkbox"/>	<> ▾	<> ▾
0 (BE)	<input type="checkbox"/>	0 ▾	0 ▾
1	<input type="checkbox"/>	0 ▾	0 ▾
2	<input type="checkbox"/>	0 ▾	0 ▾
3	<input type="checkbox"/>	0 ▾	0 ▾
59	<input type="checkbox"/>	0 ▾	0 ▾
60	<input type="checkbox"/>	0 ▾	0 ▾
61	<input type="checkbox"/>	0 ▾	0 ▾
62	<input type="checkbox"/>	0 ▾	0 ▾
63	<input type="checkbox"/>	0 ▾	0 ▾

Parameter description:

- **DSCP :**
Maximum number of supported DSCP values are 64.
- **Trust :**
Click to check if the DSCP value is trusted.
- **QoS Class :**
QoS Class value can be any of (0-7)
- **DPL :**
Drop Precedence Level (0-3)
- **Buttons:**
Apply – Click to save changes.
Reset- Click to undo any changes made locally and revert to previously saved values.
- **Auto-refresh :**
To evoke the auto-refresh icon then the device will refresh the information automatically.
- **Upper right icon (Refresh):**
You can click them for refresh the DSCP-Based QoS Ingress Classification information by manual.

3-17.9 DSCP Translation

The section describes the switch allows you to configure the basic QoS DSCP Translation settings for all switches. DSCP translation can be done in Ingress or Egress.

Web Interface

To configure the DSCP Translation parameters in the web interface:

1. Click Configuration, QoS, DSCP Translation
2. Scroll to set the Ingress Translate and Egress Remap DP0 and Remap DP1 Parameters
3. Evoke to enable or disable Classify
4. Click the save to save the setting
5. If you want to cancel the setting then you need to click the Reset button.
It will revert to previously saved values

Figure 3-16.9: The DSCP Translation Configuration

DSCP Translation Home > Configuration > QoS > DSCP Translation

DSCP	Ingress		Egress	
	Translate	Classify	Remap DP0	Remap DP1
*	<> <input type="button" value="v"/>	<input type="checkbox"/>	<> <input type="button" value="v"/>	<> <input type="button" value="v"/>
0 (BE)	0 (BE) <input type="button" value="v"/>	<input type="checkbox"/>	0 (BE) <input type="button" value="v"/>	0 (BE) <input type="button" value="v"/>
1	1 <input type="button" value="v"/>	<input type="checkbox"/>	1 <input type="button" value="v"/>	1 <input type="button" value="v"/>
2	2 <input type="button" value="v"/>	<input type="checkbox"/>	2 <input type="button" value="v"/>	2 <input type="button" value="v"/>
61	61 <input type="button" value="v"/>	<input type="checkbox"/>	61 <input type="button" value="v"/>	61 <input type="button" value="v"/>
62	62 <input type="button" value="v"/>	<input type="checkbox"/>	62 <input type="button" value="v"/>	62 <input type="button" value="v"/>
63	63 <input type="button" value="v"/>	<input type="checkbox"/>	63 <input type="button" value="v"/>	63 <input type="button" value="v"/>

Parameter description:

- **DSCP :**

Maximum number of supported DSCP values are 64 and valid DSCP value ranges from 0 to 63.

- **Ingress :**

Ingress side DSCP can be first translated to new DSCP before using the DSCP for QoS class and DPL map.

There are two configuration parameters for DSCP Translation –

1. **Translate :** DSCP at Ingress side can be translated to any of (0-63) DSCP values.
2. **Classify :** Click to enable Classification at Ingress side.

- **Egress :**

There are following configurable parameters for Egress side –

1. **Remap DP0 :** Select the DSCP value from select menu to which you want to remap. DSCP value ranges form 0 to 63
2. **Remap DP1 :** Select the DSCP value from select menu to which you want to remap. DSCP value ranges form 0 to 63.

There is following configurable parameter for Egress side -

- **Remap:** Select the DSCP value from select menu to which you want to remap. DSCP value ranges form 0 to 63.

- **Buttons:**

Apply – Click to save changes.

Reset- Click to undo any changes made locally and revert to previously saved values.

- **Auto-refresh :**

To evoke the auto-refresh icon then the device will refresh the information automatically.

- **Upper right icon (Refresh):**

You can click them for refresh the DSCP Translation information by manual.

3-17.10 DSCP Classification

The section describes to teach user to configure and allows you to map DSCP value to a QoS Class and DPL value. Others the settings relate to the currently selected stack unit, as reflected by the page header.

Web Interface

To configure the DSCP Classification parameters in the web interface:

1. Click Configuration, QoS, DSCP Translation
2. Scroll to set the DSCP Parameters
3. Click the save to save the setting
4. If you want to cancel the setting then you need to click the Reset button.
It will revert to previously saved values

Figure 3-16.10: The DSCP Classification Configuration

DSCP Classification Home > Configuration > QoS > DSCP Classification

QoS Class	DPL	DSCP
*	*	<> ▼
0	0	0 (BE) ▼
0	1	0 (BE) ▼
1	0	0 (BE) ▼
1	1	0 (BE) ▼
2	0	0 (BE) ▼
2	1	0 (BE) ▼
3	0	0 (BE) ▼
3	1	0 (BE) ▼
4	0	0 (BE) ▼
4	1	0 (BE) ▼
5	0	0 (BE) ▼
5	1	0 (BE) ▼
6	0	0 (BE) ▼
6	1	0 (BE) ▼
7	0	0 (BE) ▼
7	1	0 (BE) ▼

Parameter description:

- **QoS Class :**

Available QoS Class value ranges from 0 to 7. QoS Class (0-7) can be mapped to followed parameters.

- **DPL :**
Drop Precedence Level (0-1) can be configured for all available QoS Classes.
- **DSCP :**
Select DSCP value (0-63) from DSCP menu to map DSCP to corresponding QoS Class and DPL value
- **Buttons:**
Apply – Click to save changes.
Reset- Click to undo any changes made locally and revert to previously saved values.
- **Auto-refresh :**
To evoke the auto-refresh icon then the device will refresh the information automatically.
- **Upper right icon (Refresh):**
You can click them for refresh the DSCP Classification information by manual.

3-17.11 QoS Control List Configuration

The section shows the QoS Control List(QCL), which is made up of the QCEs. Each row describes a QCE that is defined. The maximum number of QCEs is 256 on each switch. Click on the lowest plus sign to add a new QCE to the list.

Web Interface

To configure the QoS Control List parameters in the web interface:



1. Click Configuration, QoS, QoS Control List
2. Click the  to add a new QoS Control List
3. Scroll all parameters and evoke the Port Member to join the QCE rules
4. Click the save to save the setting
5. If you want to cancel the setting then you need to click the Reset button.
It will revert to previously saved values

Figure 3-17.11: The QoS Control List Configuration

Home > Configuration > QoS > QoS Control List

QCE	Port	DMAC	SMAC	Tag Type	VID	PCP	DEI	Frame Type	Action			
									CoS	DPL	DSCP	
												

Home > Configuration > QoS > QoS Control List

Port Members

1	2	3	4	5	6	7	8	9	10	11	12	13	14	15	16	17	18	19	20	21	22	23	24	25	26
<input checked="" type="checkbox"/>	<input checked="" type="checkbox"/>	<input checked="" type="checkbox"/>	<input checked="" type="checkbox"/>	<input checked="" type="checkbox"/>	<input checked="" type="checkbox"/>	<input checked="" type="checkbox"/>	<input checked="" type="checkbox"/>	<input checked="" type="checkbox"/>	<input checked="" type="checkbox"/>	<input checked="" type="checkbox"/>	<input checked="" type="checkbox"/>	<input checked="" type="checkbox"/>	<input checked="" type="checkbox"/>	<input checked="" type="checkbox"/>	<input checked="" type="checkbox"/>	<input checked="" type="checkbox"/>	<input checked="" type="checkbox"/>	<input checked="" type="checkbox"/>	<input checked="" type="checkbox"/>	<input checked="" type="checkbox"/>	<input checked="" type="checkbox"/>	<input checked="" type="checkbox"/>	<input checked="" type="checkbox"/>	<input checked="" type="checkbox"/>	<input checked="" type="checkbox"/>

DMAC:

SMAC:

Tag:

VID:

PCP:

DEI:

Frame Type:

Action Parameters

CoS	0 <input type="button" value="v"/>
DPL	Default <input type="button" value="v"/>
DSCP	Default <input type="button" value="v"/>

Apply
Reset
Cancel

Parameter description:

- **QCE# :**
Indicates the index of QCE.
- **Port :**
Indicates the list of ports configured with the QCE.
- **DMAC :**
Indicates the destination MAC address. Possible values are:
Any: Match any DMAC.
Unicast: Match unicast DMAC.
Multicast: Match multicast DMAC.
Broadcast: Match broadcast DMAC.
<MAC>: Match specific DMAC.
The default value is 'Any'.
- **SMAC :**
Match specific source MAC address or 'Any'.
If a port is configured to match on DMAC/DIP, this field indicates the DMAC.
- **Tag Type :**
Indicates tag type. Possible values are:
Any: Match tagged and untagged frames.
Untagged: Match untagged frames.
Tagged: Match tagged frames.
C-Tagged: Match C-tagged frames.
S-Tagged: Match S-tagged frames.
The default value is 'Any'.
- **VID :**
Indicates ([VLAN ID](#)), either a specific VID or range of VIDs. VID can be in the range 1-4095 or 'Any'
- **PCP :**
Priority Code Point: Valid values of PCP are specific(0, 1, 2, 3, 4, 5, 6, 7) or range(0-1, 2-3, 4-5, 6-7, 0-3, 4-7) or 'Any'.
- **DEI :**
Drop Eligible Indicator: Valid value of DEI are 0, 1 or 'Any'.
- **Frame Type :**

Indicates the type of frame to look for incoming frames. Possible frame types are:

Any: The QCE will match all frame type.

Ethernet: Only Ethernet frames (with Ether Type 0x600-0xFFFF) are allowed.

LLC: Only (LLC) frames are allowed.

SNAP: Only (SNAP) frames are allowed

IPv4: The QCE will match only IPV4 frames.

IPv6: The QCE will match only IPV6 frames.

- **Action :**

Indicates the classification action taken on ingress frame if parameters configured are matched with the frame's content.

There are three action fields: Class, DPL and DSCP.

Class: Classified QoS Class; if a frame matches the QCE it will be put in the queue.

DPL: Drop Precedence Level; if a frame matches the QCE then DP level will set to value displayed under DPL column.

DSCP: If a frame matches the QCE then DSCP will be classified with the value displayed under DSCP column.

- **Modification Buttons :**

You can modify each QCE (QoS Control Entry) in the table using the following buttons:



: Inserts a new QCE before the current row.



: Edits the QCE.



: Moves the QCE up the list.



: Moves the QCE down the list.



: Deletes the QCE.



: The lowest plus sign adds a new entry at the bottom of the QCE listings.

- **Port Members :**

Check the checkbox button in case you want to make any port member of the QCL entry. By default all ports will be checked

- **Key Parameters :**

Key configuration are described as below:

Tag Value of Tag field can be 'Any', 'Untag' or 'Tag'

VID Valid value of VLAN ID can be any value in the range 1-4095 or 'Any'; user can enter either a specific value or a range of VIDs

PCP Priority Code Point: Valid value PCP are specific(0, 1, 2, 3, 4, 5, 6, 7) or range(0-1, 2-3, 4-5, 6-7, 0-3, 4-7) or 'Any'

DEI Drop Eligible Indicator: Valid value of DEI can be any of values between 0, 1 or 'Any'

SMAC Source MAC address: 24 MS bits (OUI) or 'Any'

DMAC Type Destination MAC type: possible values are unicast(UC), multicast(MC), broadcast(BC) or 'Any'

Frame Type Frame Type can have any of the following values

1. Any
2. Ethernet
3. LLC
4. SNAP
5. IPv4

6. IPv6



NOTE: All frame types are explained below:

1. Any : Allow all types of frames.

2. Ethernet : Ethernet Type Valid ethernet type can have value within 0x600-0xFFFF or 'Any', default value is 'Any'.

3. LLC: SSAP Address Valid SSAP(Source Service Access Point) can vary from 0x00 to 0xFF or 'Any', the default value is 'Any'
 DSAP Address Valid DSAP(Destination Service Access Point) can vary from 0x00 to 0xFF or 'Any', the default value is 'Any'
 Control Address Valid Control Address can vary from 0x00 to 0xFF or 'Any', the default value is 'Any'

4. SNAP : PID Valid PID(a.k.a ethernet type) can have value within 0x00-0xFFFF or 'Any', default value is 'Any'

5. IPv4 : Protocol IP protocol number: (0-255, TCP or UDP) or 'Any'
 Source IP Specific Source IP address in value/mask format or 'Any'.
 IP and Mask are in the format x.y.z.w where x, y, z, and w are decimal numbers between 0 and 255. When Mask is converted to a 32-bit binary string and read from left to right, all bits following the first zero must also be zero
 DSCP Diffserv Code Point value(DSCP): It can be specific value, range of value or 'Any'. DSCP values are in the range 0-63 including BE, CS1-CS7, EF or AF11-AF43

IP Fragment IPv4 frame fragmented option: yes|no|any

Sport Source TCP/UDP port:(0-65535) or 'Any', specific or port range applicable for IP protocol UDP/TCP

Dport Destination TCP/UDP port:(0-65535) or 'Any', specific or port range applicable for IP protocol UDP/TCP

6. IPv6 :Protocol IP protocol number: (0-255, TCP or UDP) or 'Any'

Source IP IPv6 source address: (a.b.c.d) or 'Any', 32 LS bits

DSCP Diffserv Code Point value(DSCP): It can be specific value, range of value or 'Any'. DSCP values are in the range 0-63 including BE, CS1-CS7, EF or AF11-AF43

Sport Source TCP/UDP port:(0-65535) or 'Any', specific or port range applicable for IP protocol UDP/TCP

Dport Destination TCP/UDP port:(0-65535) or 'Any', specific or port range applicable for IP protocol UDP/TCP

- **Action Configuration :**

Class QoS Class: "class (0-7)", default- basic classification

DP Valid DP Level can be (0-3)", default- basic classification

DSCP Valid dscp value can be (0-63, BE, CS1-CS7, EF or AF11-AF43)

- **Buttons:**

Apply – Click to save changes.

Reset- Click to undo any changes made locally and revert to previously saved values.

3-17.12 Storm Control

The section allows user to configure the Storm control for the switch. There is a unicast storm rate control, multicast storm rate control, and a broadcast storm rate control. These only affect flooded frames, i.e. frames with a (VLAN ID, DMAC) pair not present on the MAC Address table. The configuration indicates the permitted packet rate for unicast, multicast or broadcast traffic across the switch

Web Interface

To configure the Storm Control Configuration parameters in the web interface:

1. Click Configuration, QoS, Storm Control Configuration
2. Evoke to select the frame type to enable storm control
3. Scroll to set the Rate Parameters
4. Click the save to save the setting
5. If you want to cancel the setting then you need to click the Reset button.
It will revert to previously saved values

Figure 3-16.12: The Storm Control Configuration

Storm Control Configuration Home > Configuration > QoS > Storm Control

Frame Type	Enable	Rate (pps)
Unicast	<input type="checkbox"/>	1 <input type="button" value="v"/>
Multicast	<input type="checkbox"/>	1 <input type="button" value="v"/>
Broadcast	<input type="checkbox"/>	1 <input type="button" value="v"/>

Parameter description:

- **Frame Type :**

The settings in a particular row apply to the frame type listed here: Unicast, Multicast or Broadcast.

- **Enable :**

Enable or disable the storm control status for the given frame type.

- **Rate :**

The rate unit is packets per second (pps). Valid values are: 1, 2, 4, 8, 16, 32, 64, 128, 256, 512, 1K, 2K, 4K, 8K, 16K, 32K, 64K, 128K, 256K, 512K or 1024K. , 1024K, 2048K, 4096K, 8192K, 16384K or 32768K. , 1024K, 2048K, 4096K, 8192K, 16384K or 32768K.

The 1 kpps is actually 1002.1 pps.

- **Buttons:**

Apply – Click to save changes.

Reset- Click to undo any changes made locally and revert to previously saved values.

3-18 Mirror

You can mirror traffic from any source port to a target port for real-time analysis. You can then attach a logic analyzer or RMON probe to the target port and study the traffic crossing the source port in a completely unobtrusive manner.

Mirror Configuration is to monitor the traffic of the network. For example, we assume that Port A and Port B are Monitoring Port and Monitored Port respectively, thus, the traffic received by Port B will be copied to Port A for monitoring.

Web Interface

To configure the Mirror in the web interface:

1. Click Configuration, Mirroring
2. Scroll to select Port to mirror on which port
3. Scroll to disabled, enable, TX Only and RX Only to set the Port mirror mode
4. Click the save to save the setting
5. If you want to cancel the setting then you need to click the Reset button.
It will revert to previously saved values

Figure 3-18: The Mirror Configuration

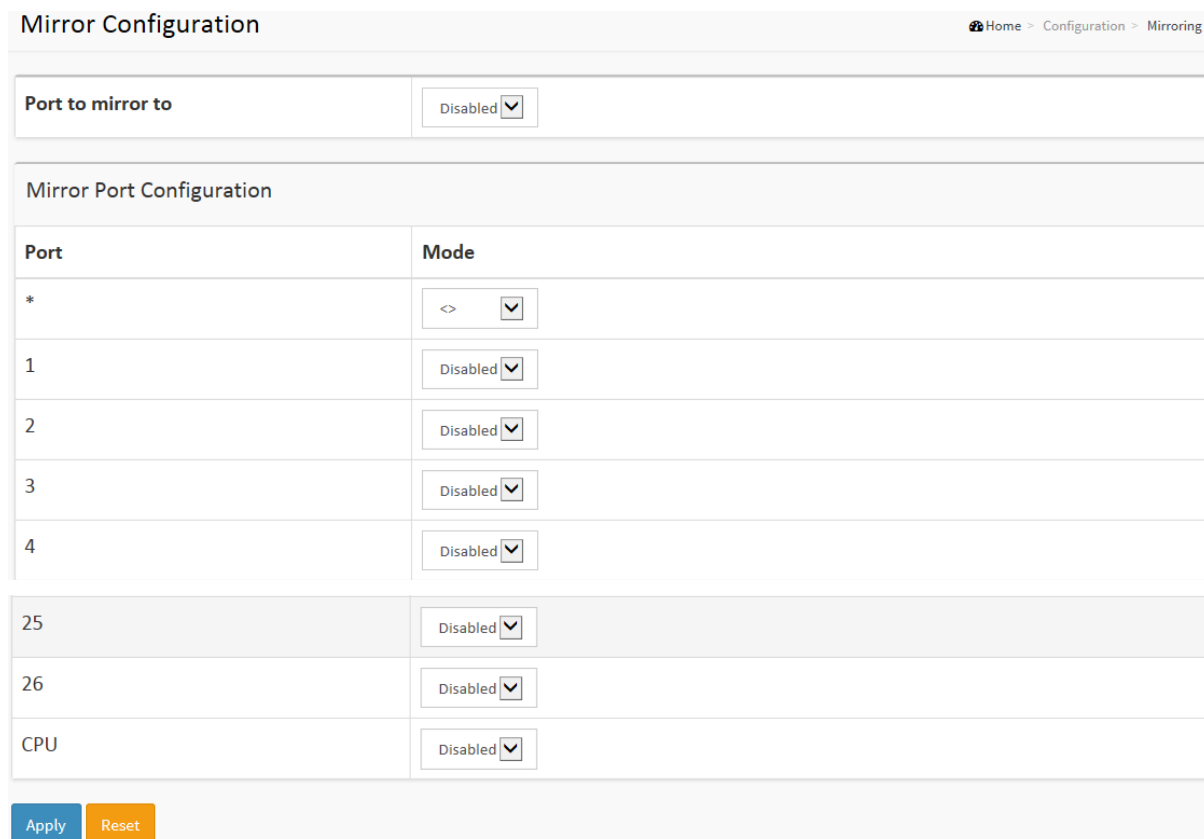

Mirror Configuration Home > Configuration > Mirroring

Port to mirror to: Disabled

Port	Mode
*	<>
1	Disabled
2	Disabled
3	Disabled
4	Disabled
25	Disabled
26	Disabled
CPU	Disabled

Apply Reset

Parameter description:

- **Port to mirror on :**

Port to mirror also known as the mirror port. Frames from ports that have either source (rx) or destination (tx) mirroring enabled are mirrored on this port. Disabled disables mirroring.

Mirror Port Configuration

The following table is used for Rx and Tx enabling.

- **Port :**

The logical port for the settings contained in the same row.

- **Mode :**

Select mirror mode.

Rx only Frames received on this port are mirrored on the mirror port. Frames transmitted are not mirrored.

Tx only Frames transmitted on this port are mirrored on the mirror port. Frames received are not mirrored.

Disabled Neither frames transmitted nor frames received are mirrored.

Enabled Frames received and frames transmitted are mirrored on the mirror port.



NOTE: For a given port, a frame is only transmitted once. It is therefore not possible to mirror Tx frames on the mirror port. Because of this, mode for the selected mirror port is limited to Disabled or Rx only.

- **Buttons:**

Apply – Click to save changes.

Reset- Click to undo any changes made locally and revert to previously saved values.

3-19 UPnP

UPnP is an acronym for Universal Plug and Play. The goals of UPnP are to allow devices to connect seamlessly and to simplify the implementation of networks in the home (data sharing, communications, and entertainment) and in corporate environments for simplified installation of computer components

Web Interface

To configure the UPnP Configuration in the web interface:

1. Click Configuration, UPnP
2. Scroll to select the mode to enable or disable
3. Specify the parameters in each blank field.
4. Click the save to save the setting
5. If you want to cancel the setting then you need to click the Reset button.
It will revert to previously saved values

Figure 3-19: The UPnP Configuration

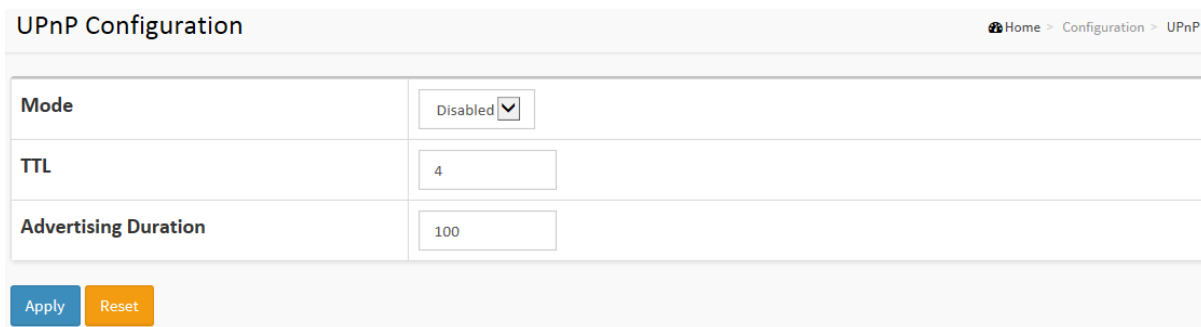

Mode	Disabled ▼
TTL	4
Advertising Duration	100

Apply Reset

Parameter description:

These parameters are displayed on the UPnP Configuration page:

- **Mode :**

Indicates the UPnP operation mode. Possible modes are:

Enabled: Enable UPnP mode operation.

Disabled: Disable UPnP mode operation.

When the mode is enabled, two ACEs are added automatically to trap UPNP related packets to CPU. The ACEs are automatically removed when the mode is disabled. .

- **TTL :**

The TTL value is used by UPnP to send SSDP advertisement messages. Valid values are in the range 1 to 255.

- **Advertising Duration :**

The duration, carried in SSDP packets, is used to inform a control point or control points how often it or they should receive an SSDP advertisement message from this switch. If a control point does not receive any message within the duration, it will think that the switch no longer exists. Due to the unreliable nature of UDP, in the standard it is recommended that such refreshing of advertisements to be done at less than one-half of the advertising duration. In the implementation, the switch sends SSDP messages periodically at the interval one-half of the advertising duration minus 30 seconds. Valid values are in the range 100 to 86400.

- **Buttons:**

Apply – Click to save changes.

Reset- Click to undo any changes made locally and revert to previously saved

values.

Chapter 4. Switch- Monitor

This chapter describes all of the basic network statistics which includes the Ports, Layer 2 network protocol (e.g. NAS, ACL, DHCP, AAA and RMON etc.) and any setting of the Switch.

4-1 System

After you login, the switch shows you the system information. This page is default and tells you the basic information of the system, including “Model Name”, “System Description”, “Contact”, “Location”, “System Up Time”, “Firmware Version”, “Host Mac Address”, “Device Port”. With this information, you will know the software version used, MAC address, serial number, how many ports good and so on. This is helpful while malfunctioning.

4-1.1 Information

The switch system information is provided here.

Web interface

To configure System Information in the web interface:

1. Click Monitor, System and Information.
2. Check the contact information for the system administrator as well as the name and location of the switch. Also indicate the local time zone by configuring the appropriate offset.
3. Click the “Refresh”

Figure 4-1.1: System Information

System Information	
Model Name	
System Description	24xGE PoE + 2xGE Combo SFP VivoCam Managed Switch
Location	VIVOTEK
Contact	
System Name	AW-GEV-264A-180
System Date	2011-01-01T01:41:06+00:00
System Uptime	01:41:06
Bootloader Version	v1.15a
Firmware Version	v6.04 2014-12-04

Hardware Version	v1.01
Mechanical Version	v1.01
MAC Address	00-02-d1-40-c7-89
Memory	Total=83166 KBytes, Free=61553 KBytes, Max=61419 KBytes
FLASH	0x40000000-0x41ffffff, 512 x 0x10000 blocks

Parameter description:

- **Model Name**
Displays the factory defined model name for identification purpose.
- **System Description**
Displays the system description.
- **Location**
The system location configured in Configuration | System | Information | System Location.
- **Contact**
The system contact configured in Configuration | System | Information | System Contact.
- **Platform Name**
Displays the user-defined system name that configured in System | System Information | Configuration | System Name.
- **System Date**
The current (GMT) system time and date. The system time is obtained through the Timing server running on the switch, if any.
- **System Uptime**
The period of time the device has been operational.
- **Bootloader Version**
Displays the current boot loader version number.
- **Firmware Version**
The software version of this switch.
- **Hardware-Mechanical Version**
The hardware and mechanical version of this switch.
- **Series Number**
The serial number of this switch.
- **MAC Address**
The MAC Address of this switch.
- **Memory**
Displays the memory size of the system.
- **FLASH**
Displays the flash size of the system.

4-1.2 IP Status

This page displays the status of the IP protocol layer. The status is defined by the IP interfaces, the IP routes and the neighbour cache (ARP cache) status.

Web Interface

To display the log configuration in the web interface:

1. Click Monitor, System and IP Status.
2. Display the IP address information.

Figure 4- 1.2: The IP Status

IP Interfaces Home > Monitor > System > IP Status

Auto-refresh 

IP Interfaces			
Interface	Type	Address	Status
OS:lo	LINK	00-00-00-00-00-00	<UP LOOPBACK RUNNING MULTICAST>
OS:lo	IPv4	127.0.0.1/8	
OS:lo	IPv6	::1/128	
OS:lo	IPv6	fe80:1::1/64	
VLAN1	LINK	00-40-c7-01-02-03	<UP BROADCAST RUNNING MULTICAST>
VLAN1	IPv4	192.168.1.1/24	
VLAN1	IPv6	fe80:2::240:c7ff:fe01:203/64	
VLAN4096	LINK	00-40-c7-01-02-03	<BROADCAST MULTICAST>

IP Routes		
Network	Gateway	Status
0.0.0.0/0	192.168.1.254	<UP GATEWAY HW_RT>
127.0.0.1/32	127.0.0.1	<UP HOST>
192.168.1.0/24	VLAN1	<UP HW_RT>
::1/128	::1	<UP HOST>

Neighbour cache	
IP Address	Link Address
192.168.1.100	VLAN1:3c-97-0e-16-eb-7e
fe80:2::240:c7ff:fe01:203	VLAN1:00-40-c7-01-02-03

Parameter description:

IP Interfaces

- **Interface**
Show the name of the interface.
- **Type**
Show the address type of the entry. This may be LINK or IPv4.
- **Address**
Show the current address of the interface (of the given type).
- **Status**
Show the status flags of the interface (and/or address).

IP Routes

- **Network**
Show the destination IP network or host address of this route.
- **Gateway**
Show the gateway address of this route.
- **Status**
Show the status flags of the route.

Neighbour cache

- **IP Address**
Show the IP address of the entry.
- **Link Address**
Show the Link (MAC) address for which a binding to the IP address given exist.

- **Buttons**

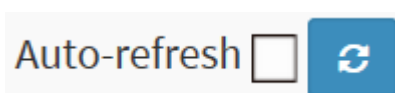

Auto-refresh: Check this box to refresh the page automatically. Automatic refresh occurs every 3 seconds.

Refresh: Click to refresh the page immediately.

4-1.3 Log

This section describes that display the system log information of the switch

Web Interface



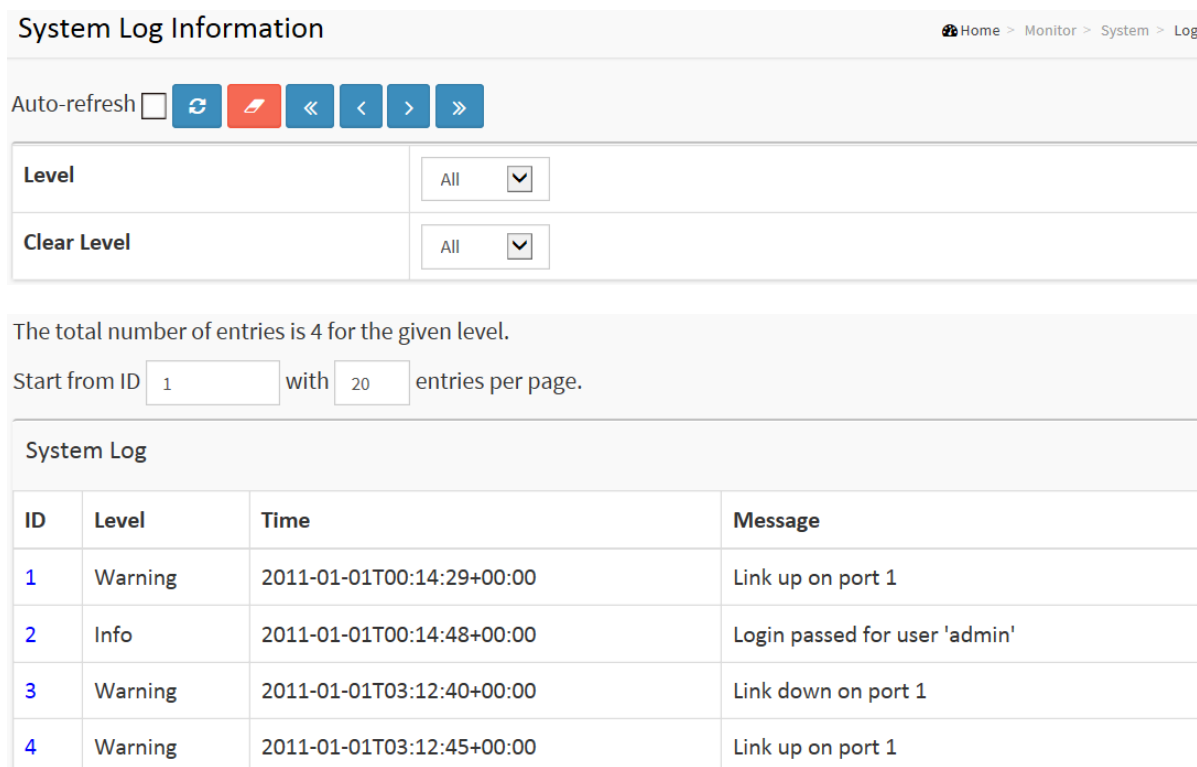

To display the log configuration in the web interface:

1. Click Monitor, System and Log.
2. Display the log information.

Figure 4- 1.3: The System Log Information



System Log Information Home > Monitor > System > Log

Auto-refresh    

Level	All <input type="button" value="v"/>
Clear Level	All <input type="button" value="v"/>

The total number of entries is 4 for the given level.

Start from ID with entries per page.

System Log			
ID	Level	Time	Message
1	Warning	2011-01-01T00:14:29+00:00	Link up on port 1
2	Info	2011-01-01T00:14:48+00:00	Login passed for user 'admin'
3	Warning	2011-01-01T03:12:40+00:00	Link down on port 1
4	Warning	2011-01-01T03:12:45+00:00	Link up on port 1

Parameter description:

- **Auto-refresh**

To evoke the auto-refresh icon then the device will refresh the log automatically.

- **Level**

level of the system log entry. The following level types are supported: Information level of the system log.

Warning: Warning level of the system log.

Error: Error level of the system log. All: All levels.

- **ID**

ID (≥ 1) of the system log entry.

- **Time**

It will display the log record by device time. The time of the system log entry.

- **Message**

It will display the log detail message. The message of the system log entry.

- **Buttons**



Auto-refresh: Check this box to refresh the page automatically. Automatic refresh occurs every 3 seconds.

Refresh: Updates the system log entries, starting from the current entry ID.

Clear: Flushes the selected log entries.

|<<: Updates the system log entries, starting from the first available entry ID.

<< : Updates the system log entries, ending at the last entry currently displayed.

>> : Updates the system log entries, starting from the last entry currently displayed.

>>|: Updates the system log entries, ending at the last available entry ID

4-1.4 Detailed Log

This section describes that display the detailed log information of the switch

Web Interface

To display the detailed log configuration in the web interface:

1. Click Monitor, System and Detailed Log.
2. Display the log information.

Figure 4- 1.4: The Detailed System Log Information

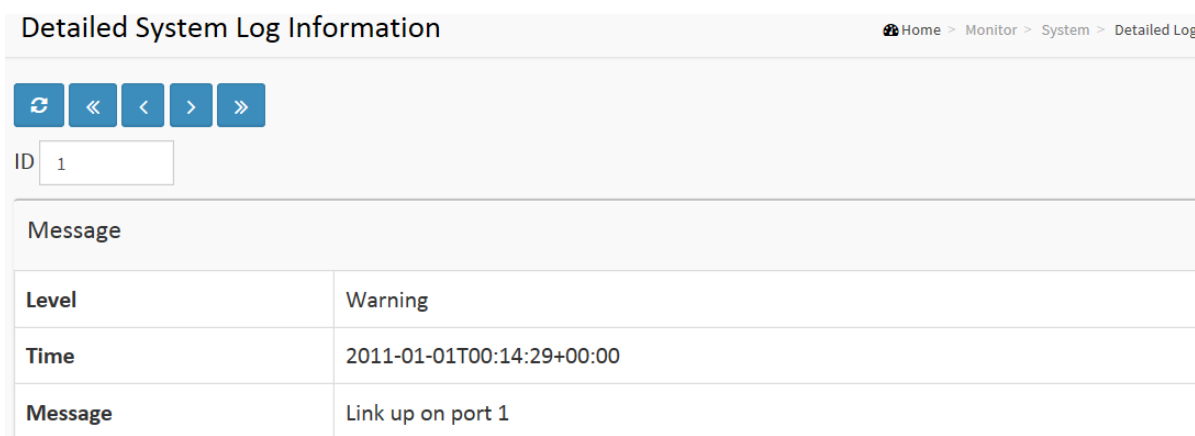

Detailed System Log Information Home > Monitor > System > Detailed Log

ID

Message	
Level	Warning
Time	2011-01-01T00:14:29+00:00
Message	Link up on port 1

Parameter description:

- **ID**
The ID (≥ 1) of the system log entry.
- **Message**
The detailed message of the system log entry.
- **Upper right icon (Refresh, clear...)**
You can click them for refresh the system log or clear them by manual, others for next/up page or entry.
- **Buttons**



Refresh: Updates the system log entries, starting from the current entry ID.

|<<: Updates the system log entries to the first available entry ID

<< : Updates the system log entry to the previous available entry ID

>> : Updates the system log entry to the next available entry ID

>>|: Updates the system log entry to the last available entry ID.

4-2 Green Ethernet

4-2.1 Port Power Savings

This page provides the current status for EEE.

Web Interface









To display the power Saving in the web interface:

1. Click Monitor, Port Power Savings.

Figure 4- 2.1: The Ports States

Port Power Savings Status Home > Monitor > Green Ethernet > Port Power Savings

Auto-refresh 

Port	Link	EEE	LP EEE Cap	EEE Savings	ActiPhy Savings	PerfectReach Savings
1		✗	✓	✗	✗	✗
2		✗	✗	✗	✗	✗
3		✗	✗	✗	✗	✗
4		✗	✗	✗	✗	✗
23		✗	✗	✗	✗	✗
24		✗	✗	✗	✗	✗
25		✗	✗	✗	✗	✗
26		✗	✗	✗	✗	✗

Parameter description:

- **Local Port**

This is the logical port number for this row.

- **Link**

Shows if the link is up for the port (green = link up, red = link down).

- **EEE**

Shows if EEE is enabled for the port (reflects the settings at the Port Power Savings configuration page).

- **LP EEE cap**

Shows if the link partner is EEE capable.

- **EEE Savings**

Shows if the system is currently saving power due to EEE. When EEE is enabled, the system will powered down if no frame has been received or transmitted in 5 uSec.

- **ActiPhy Savings**

Shows if the system is currently saving power due to ActiPhy.

- **PerfectReach Savings**

Shows if the system is currently saving power due to PerfectReach.

4-3 Ports

The section describes to configure the Port detail parameters of the switch. Others you could using the Port configure to enable or disable the Port of the switch. Monitor the ports content or status in the function.

4-3.1 Traffic Overview

The section describes to the Port statistics information and provides overview of general traffic statistics for all switch ports.

Web Interface

To Display the Port Statistics Overview in the web interface:

1. Click Monitor, Port, then Traffic Overview
2. If you want to auto-refresh then you need to evoke the “Auto-refresh”.
3. Click “Refresh” to refresh the port statistics or clear all information when you click “ Clear”.

Figure 4-3.1: The Port Statistics Overview

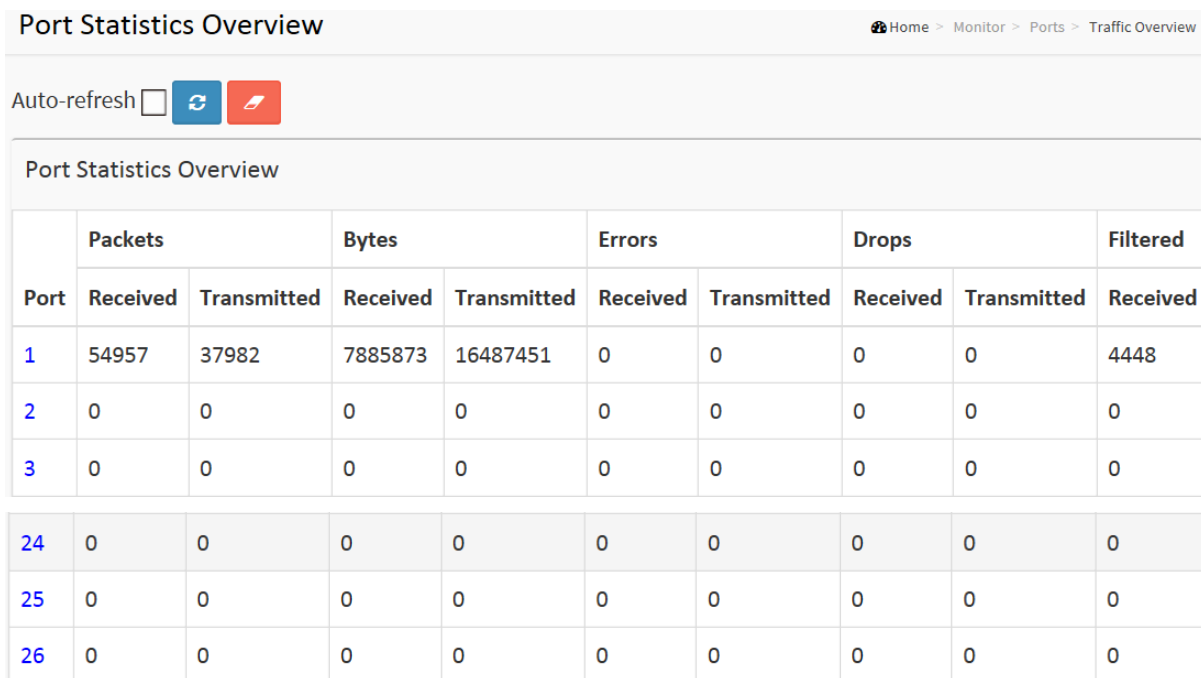

Port	Packets		Bytes		Errors		Drops		Filtered
	Received	Transmitted	Received	Transmitted	Received	Transmitted	Received	Transmitted	Received
1	54957	37982	7885873	16487451	0	0	0	0	4448
2	0	0	0	0	0	0	0	0	0
3	0	0	0	0	0	0	0	0	0
24	0	0	0	0	0	0	0	0	0
25	0	0	0	0	0	0	0	0	0
26	0	0	0	0	0	0	0	0	0

Parameter description:

- **Port :**

The logical port for the settings contained in the same row.

- **Packets :**

The number of received and transmitted packets per port.

- **Bytes :**

The number of received and transmitted bytes per port.

- **Errors**

The number of frames received in error and the number of incomplete

transmissions per port.

- **Drops**

The number of frames discarded due to ingress or egress congestion.

- **Filtered**

The number of received frames filtered by the forwarding

- **Buttons**

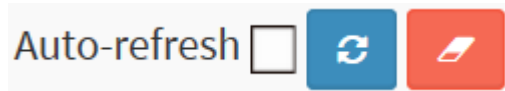

Auto-refresh: Check this box to refresh the page automatically. Automatic refresh occurs every 3 seconds.

Refresh: Click to refresh the page.

Clear: Clears the counters for all ports.

4-3.2 Qos Statistics



The section describes that switch could display the QoS detailed Queuing counters for a specific switch port. for the different queues for all switch ports.

Web Interface

To Display the Queuing Counters in the web interface:

1. Click Monitor, Ports, then QoS Statistics
2. If you want to auto-refresh the information then you need to evoke the “Auto-refresh”.
3. Click “Refresh” to refresh the Queuing Counters or clear all information when you click “Clear”.

Figure 4-3.2: The Queuing Counters Overview

Queuing Counters																
Home > Monitor > Ports > QoS Statistics																
Auto-refresh <input type="checkbox"/>  																
Port	Q0		Q1		Q2		Q3		Q4		Q5		Q6		Q7	
	Rx	Tx	Rx	Tx	Rx	Tx	Rx	Tx	Rx	Tx	Rx	Tx	Rx	Tx	Rx	Tx
1	56003	0	0	0	0	0	0	0	0	0	0	0	0	0	0	38635
2	0	0	0	0	0	0	0	0	0	0	0	0	0	0	0	0
3	0	0	0	0	0	0	0	0	0	0	0	0	0	0	0	0
4	0	0	0	0	0	0	0	0	0	0	0	0	0	0	0	0
23	0	0	0	0	0	0	0	0	0	0	0	0	0	0	0	0
24	0	0	0	0	0	0	0	0	0	0	0	0	0	0	0	0
25	0	0	0	0	0	0	0	0	0	0	0	0	0	0	0	0
26	0	0	0	0	0	0	0	0	0	0	0	0	0	0	0	0

Parameter description:

- **Port :**
The logical port for the settings contained in the same row.
- **Qn :**
Qn is the Queue number, There are 8 QoS queues per port. Q0 is the lowest priority queue.
- **Rx/Tx :**
The number of received and transmitted packets per queue.

- **Buttons**

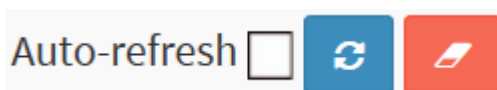

Auto-refresh: Check this box to refresh the page automatically. Automatic refresh occurs every 3 seconds.

Refresh: Click to refresh the page.

Clear: Clears the counters for all ports.

4-3.3 QCL Status

The section will let you know how to configure and shows the QCL status by different QCL users. Each row describes the QCE that is defined. It is a conflict if a specific QCE is not applied to the hardware due to hardware limitations. The maximum number of QCEs is 256 on each switch.

Web Interface

To display the QoS Control List Status in the web interface:

1. Click Monitor, Ports, then QCL Status
2. If you want to auto-refresh the information then you need to evoke the “Auto-refresh”.
3. Scroll to select the combined, static, Voice VLAN and conflict.
4. To Click the “Refresh” to refresh an entry of the MVR Statistics Information.

Figure 4-3.3: The QoS Control List Status

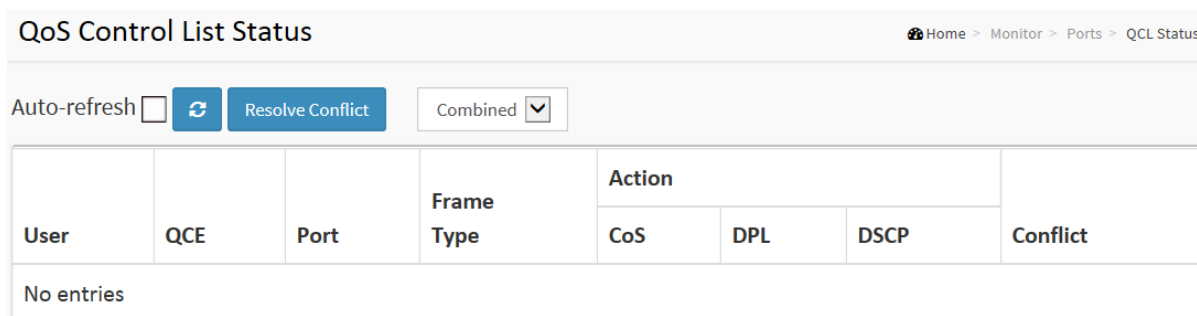

User	QCE	Port	Frame Type	Action			Conflict
				CoS	DPL	DSCP	
No entries							

Parameter description:

- **User :**
Indicates the QCL user.
- **QCE#**
Indicates the index of QCE.
- **Frame Type :**
Indicates the type of frame to look for incoming frames. Possible frame types are:
Any: The QCE will match all frame type.
Ethernet: Only Ethernet frames (with Ether Type 0x600-0xFFFF) are allowed.
LLC: Only (LLC) frames are allowed
LLC: Only (SNAP) frames are allowed.
IPv4: The QCE will match only IPV4 frames.
IPv6: The QCE will match only IPV6 frames.
- **Port :**
Indicates the list of ports configured with the QCE.
- **Action :**
Indicates the classification action taken on ingress frame if parameters configured are matched with the frame's content.
There are three action fields: Class, DPL and DSCP.
Class: Classified QoS Class; if a frame matches the QCE it will be put in the queue.

DPL: Drop Precedence Level; if a frame matches the QCE then DP level will set to value displayed under DPL column.

DSCP: If a frame matches the QCE then DSCP will be classified with the value displayed under DSCP column.

- **Conflict :**

Displays Conflict status of QCL entries. It may happen that resources required to add a QCE may not available, in that case it shows conflict status as 'Yes', otherwise it is always 'No'. Please note that conflict can be resolved by releasing the H/W resources required to add QCL entry on pressing 'Resolve Conflict' button.

- **Buttons**

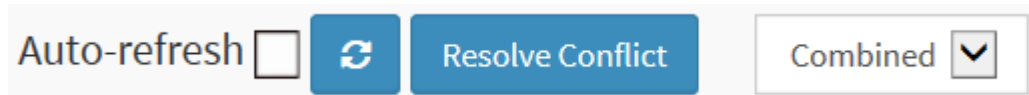

Auto-refresh: Check this box to refresh the page automatically. Automatic refresh occurs every 3 seconds.

Resolve Conflict: Click to release the resources required to add QCL entry, in case conflict status for any QCL entry is 'yes'.

Refresh: Click to refresh the page.

4-3.4 Detailed Statistics

The section describes how to provide detailed traffic statistics for a specific switch port. Use the port select box to select which switch port details to display.

The displayed counters are the totals for receive and transmit, the size counters for receive and transmit, and the error counters for receive and transmit.

Web Interface

To Display the per Port detailed Statistics Overview in the web interface:

1. Click Monitor, Ports, then Detailed Port Statistics
2. Scroll the Port Index to select which port you want to show the detailed
3. Port statistics overview” .
4. If you want to auto-refresh the information then you need to evoke the“Auto-refresh”.
5. Click “ Refresh“ to refresh the port detailed statistics or clear all information when you click “ Clear”.

Figure 4-3.4: The Detailed Port Statistics

Receive Total		Transmit Total	
Rx Packets	56754	Tx Packets	39099
Rx Octets	8138095	Tx Octets	16948240
Rx Unicast	36253	Tx Unicast	26422
Rx Multicast	8263	Tx Multicast	12673
Rx Broadcast	12238	Tx Broadcast	4
Rx Pause	0	Tx Pause	0

Receive Size Counters		Transmit Size Counters	
Rx 64 Bytes	34048	Tx 64 Bytes	871
Rx 65-127 Bytes	7938	Tx 65-127 Bytes	12926
Rx 128-255 Bytes	5161	Tx 128-255 Bytes	9476
Rx 256-511 Bytes	9176	Tx 256-511 Bytes	7900
Rx 512-1023 Bytes	431	Tx 512-1023 Bytes	42
Rx 1024-1526 Bytes	0	Tx 1024-1526 Bytes	7884
Rx 1527- Bytes	0	Tx 1527- Bytes	0

Receive Queue Counters		Transmit Queue Counters	
Rx Q0	56754	Tx Q0	0
Rx Q1	0	Tx Q1	0
Rx Q2	0	Tx Q2	0
Rx Q3	0	Tx Q3	0
Rx Q4	0	Tx Q4	0
Rx Q5	0	Tx Q5	0
Rx Q6	0	Tx Q6	0
Rx Q7	0	Tx Q7	39099

Receive Error Counters		Transmit Error Counters	
Rx Drops	0	Tx Drops	0
Rx CRC/Alignment	0	Tx Late/Exc. Coll.	0
Rx Undersize	0		
Rx Oversize	0		
Rx Fragments	0		
Rx Jabber	0		
Rx Filtered	4614		

Parameter description:

- **Auto-refresh:**

To evoke the auto-refresh to refresh the Port Statistics information automatically.

- **Upper left scroll bar:**

To scroll which port to display the Port statistics with "Port-0", "Port-1..."

Receive Total and Transmit Total

- **Rx and Tx Packets :**

The number of received and transmitted (good and bad) packets.

- **Rx and Tx Octets :**

The number of received and transmitted (good and bad) bytes. Includes FCS, but excludes framing bits.

- **Rx and Tx Unicast**

The number of received and transmitted (good and bad) unicast packets.

- **Rx and Tx Multicast :**

The number of received and transmitted (good and bad) multicast packets.

- **Rx and Tx Broadcast :**

The number of received and transmitted (good and bad) broadcast packets.

- **Rx and Tx Pause :**

A count of the MAC Control frames received or transmitted on this port that have

an opcode indicating a PAUSE operation.

Receive and Transmit Size Counters

The number of received and transmitted (good and bad) packets split into categories based on their respective frame sizes.

Receive and Transmit Queue Counters

The number of received and transmitted packets per input and output queue.

Receive Error Counters

- **Rx Drops :**
The number of frames dropped due to lack of receive buffers or egress congestion.
- **Rx CRC/Alignment :**
The number of frames received with CRC or alignment errors.
- **Rx Undersize :**
The number of short 1 frames received with valid CRC.
- **Rx Oversize :**
The number of long 2 frames received with valid CRC.
- **Rx Fragments :**
The number of short 1 frames received with invalid CRC.
- **Rx Jabber :**
The number of long 2 frames received with invalid CRC.
- **Rx Filtered :**
The number of received frames filtered by the forwarding process.
Short frames are frames that are smaller than 64 bytes.
Long frames are frames that are longer than the configured maximum frame length for this port.

Transmit Error Counters

- **Tx Drops :**
The number of frames dropped due to output buffer congestion.
- **Tx Late/Exc. Coll. :**
The number of frames dropped due to excessive or late collisions.
- **Auto-refresh:**
To evoke the auto-refresh to refresh the Queuing Counters automatically.
- **Upper right icon (Refresh, clear)**
You can click them for refresh the Port Detail Statistics or clear them by manual.
- **Buttons**

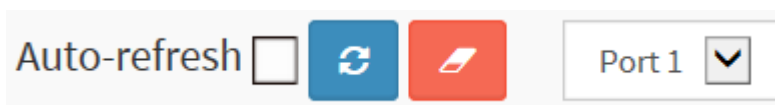

Auto-refresh: Check this box to refresh the page automatically. Automatic refresh occurs every 3 seconds.

Clear: Clears the counters for the selected port.

Refresh: Click to refresh the page.

4-4 DHCP

4-4.1 Server

DHCP Server is used to allocate network addresses and deliver configuration parameters to dynamically configured hosts called DHCP client.

4-4.1.1 Statistics



This page displays the database counters and the number of DHCP messages sent and received by DHCP server.

Web Interface

Display the DHCP server Statistics Overview in the web interface:

Click Protocol -based VLAN configuration and add new entry.

Figure 4-4.1.1: The Protocol to Group Mapping Table

DHCP Server Statistics				
Auto-refresh <input type="checkbox"/>  				
Database Counters				
Pool	Excluded IP Address	Declined IP Address		
0	0	0		
Binding Counters				
Automatic Binding	Manual Binding	Expired Binding		
0	0	0		
DHCP Message Received Counters				
DISCOVER	REQUEST	DECLINE	RELEASE	INFORM
0	0	0	0	0
DHCP Message Sent Counters				
OFFER	ACK		NAK	
0	0		0	

Parameter description:

Database Counters

- **Pool :**
Number of pools.
- **Excluded IP Address :**
Number of excluded IP address ranges.
- **Declined IP Address :**
Number of declined IP addresses.

Database Counters

- **Automatic Binding :**
Number of bindings with network-type pools.
- **Manual Binding :**
Number of bindings that administrator assigns an IP address to a client. That is, the pool is of host type.
- **Expired Binding :**
Number of bindings that their lease time expired or they are cleared from Automatic/Manual type bindings.

DHCP Message Received Counters

- **DISCOVER :**
Number of DHCP DISCOVER messages received.
- **REQUEST :**
Number of DHCP REQUEST messages received.
- **DECLINE :**
Number of DHCP DECLINE messages received.
- **RELEASE :**
Number of DHCP RELEASE messages received.
- **INFORM :**
Number of DHCP INFORM messages received.

DHCP Message Sent Counters

- **OFFER :**
Number of DHCP OFFER messages sent.
- **ACK :**
Number of DHCP ACK messages sent.
- **NAK :**
Number of DHCP NAK messages sent.

4-4.1.2 Binding

This page displays bindings generated for DHCP clients.

Web Interface

To Display DHCP Server Binding IP in the web interface:
Click DHCP, Server and Binding.

Figure 4-4.1.2: The Group Name of VLAN Mapping Table

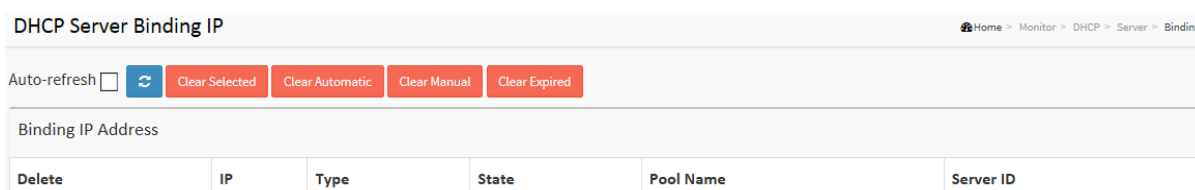

Binding IP Address					
Delete	IP	Type	State	Pool Name	Server ID

Parameter description:

- **IP :**

IP address allocated to DHCP client.

- **Type :**
Type of binding. Possible types are Automatic, Manual, Expired.
- **State :**
State of binding. Possible states are Committed, Allocated, Expired.
- **Pool Name :**
The pool that generates the binding.
- **Server ID :**
Server IP address to service the binding.

4-4.1.3 Declined IP

This page displays declined IP addresses.

Web Interface

To Display DHCP Server Declined IP in the web interface:
Click DHCP, Server and Declined IP.

Figure 4-4.1.3: The Declined IP

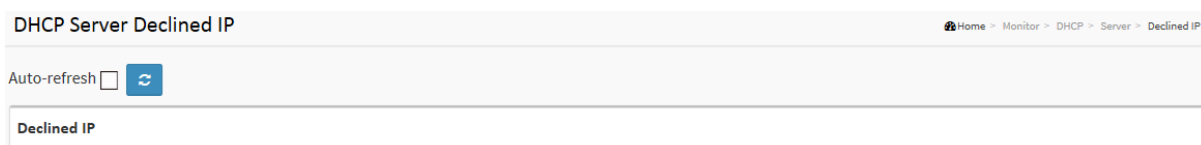

Parameter description:

- **IP :**
IP address allocated to DHCP client.
- **Type :**
Type of binding. Possible types are Automatic, Manual, Expired.
- **State :**
State of binding. Possible states are Committed, Allocated, Expired.
- **Pool Name :**
The pool that generates the binding.
- **Server ID :**
Server IP address to service the binding.

4-4.2 Snooping Table

This page displays the dynamic IP assigned information after DHCP Snooping mode is disabled. All DHCP clients obtained the dynamic IP address from the DHCP server will be listed in this table except for local VLAN interface IP addresses. Entries in the Dynamic DHCP snooping Table are shown on this page.

Web Interface

To monitor an DHCP in the web interface:
Click Monitor, DHCP, Snooping table

Figure 4-4.2: The DHCP snooping table

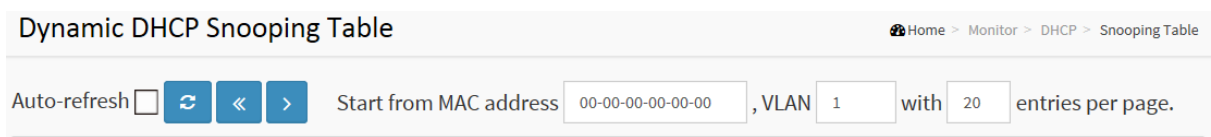

Parameter description:

- **MAC Address :**
User MAC address of the entry.
- **VLAN ID :**
VLAN-ID in which the DHCP traffic is permitted.
- **Source Port:**
Switch Port Number for which the entries are displayed.
- **IP Address :**
User IP address of the entry.
- **IP Subnet Mask :**
User IP subnet mask of the entry.
- **DHCP Server Address :**
DHCP Server address of the entry.

4-4.3 Detailed Statistics



This page provides statistics for DHCP snooping. Notice that the normal forward per-port TX statistics isn't increased if the incoming DHCP packet is done by L3 forwarding mechanism. And clear the statistics on specific port may not take effect on global statistics since it gathers the different layer overview.

Web Interface

To monitor an DHCP Relay statistics in the web interface:
Click Monitor, DHCP, Detailed Statistics

Figure 4-4.3: The DHCP Detailed Statistics

DHCP Detailed Statistics Port 1 Home > Monitor > DHCP > Detailed Statistics

Auto-refresh   Combined Port 1

Receive Packets		Transmit Packets	
Rx Discover	0	Tx Discover	0
Rx Offer	0	Tx Offer	0
Rx Request	0	Tx Request	0
Rx Decline	0	Tx Decline	0
Rx ACK	0	Tx ACK	0
Rx NAK	0	Tx NAK	0
Rx Release	0	Tx Release	0
Rx Inform	0	Tx Inform	0
Rx Lease Query	0	Tx Lease Query	0
Rx Lease Unassigned	0	Tx Lease Unassigned	0
Rx Lease Unknown	0	Tx Lease Unknown	0
Rx Lease Active	0	Tx Lease Active	0
Rx Discarded Checksum Error	0		
Rx Discarded from Untrusted	0		

Parameter description:

Server Statistics

- **Rx and Tx Discover :**

The number of discover (option 53 with value 1) packets received and transmitted.

- **Rx and Tx Offer :**

The number of offer (option 53 with value 2) packets received and transmitted.

- **Rx and Tx Request :**

The number of request (option 53 with value 3) packets received and transmitted.

- **Rx and Tx Decline:**

The number of decline (option 53 with value 4) packets received and transmitted.

- **Rx and Tx ACK:**

The number of ACK (option 53 with value 5) packets received and transmitted.

- **Rx and Tx NAK:**

The number of NAK (option 53 with value 6) packets received and transmitted.
- **Rx and Tx Release:**

The number of release (option 53 with value 7) packets received and transmitted.
- **Rx and Tx Inform:**

The number of inform (option 53 with value 8) packets received and transmitted.
- **Rx and Tx Lease Query:**

The number of lease query (option 53 with value 10) packets received and transmitted.
- **Rx and Tx Lease Unassigned:**

The number of lease unassigned (option 53 with value 11) packets received and transmitted.
- **Rx and Tx Lease Unknown:**

The number of lease unknown (option 53 with value 12) packets received and transmitted. Rx and Tx Lease Active
- **Rx and Tx Lease Active:**

The number of lease active (option 53 with value 13) packets received and transmitted.
- **Rx Discarded checksum error:**

The number of discard packet that IP/UDP checksum is error.
- **Rx Discarded from Untrusted:**

The number of discarded packet that are coming from untrusted port.

4-5 Security

4-5.1 Network

4-5.1.1 Port Security

4-5.1.1.1 Switch

This section shows the Port Security status. Port Security is a module with no direct configuration. Configuration comes indirectly from other modules - the user modules. When a user module has enabled port security on a port, the port is set-up for software-based learning. In this mode, frames from unknown MAC addresses are passed on to the port security module, which in turn asks all user modules whether to allow this new MAC address to forward or block it. For a MAC address to be set in the forwarding state, all enabled user modules must unanimously agree on allowing the MAC address to forward. If only one chooses to block it, it will be blocked until that user module decides otherwise. The status page is divided into two sections - one with a legend of user modules and one with the actual port status.

Web Interface

To configure a Port Security Switch Status Configuration in the web interface:

1. Click Security, Network, Port Security, then Switch
2. Checked "Auto-refresh".
3. Click " Refresh" to refresh the port detailed statistics.

Figure 4-5.1.1.1: The Port Security Switch Status

Auto-refresh 

User Module Legend				
User Module Name	Abbr			
Limit Control	L			
802.1X	8			
DHCP Snooping	D			

Port Status				
Port	Users	State	MAC Count	
			Current	Limit
1	----	Disabled	-	-
2	----	Disabled	-	-
3	----	Disabled	-	-
4	----	Disabled	-	-

22	----	Disabled	-	-
23	----	Disabled	-	-
24	----	Disabled	-	-
25	----	Disabled	-	-
26	----	Disabled	-	-

Parameter description:

- **User Module Legend :**

The legend shows all user modules that may request Port Security services.

- **User Module Name :**

The full name of a module that may request Port Security services.

- **Abbr :**

A one-letter abbreviation of the user module. This is used in the Users column in the port status table.

- **Port Status :**

The table has one row for each port on the selected switch and a number of columns, which are:

- **Port :**

The port number for which the status applies. Click the port number to see the status for this particular port.

- **Users :**

Each of the user modules has a column that shows whether that module has enabled Port Security or not. A '-' means that the corresponding user module is not enabled, whereas a letter indicates that the user module abbreviated by that letter (see Abbr) has enabled port security.

- **State :**

Shows the current state of the port. It can take one of four values:

Disabled: No user modules are currently using the Port Security service.

Ready: The Port Security service is in use by at least one user module, and is awaiting frames from unknown MAC addresses to arrive.

Limit Reached: The Port Security service is enabled by at least the Limit Control user module, and that module has indicated that the limit is reached and no more MAC addresses should be taken in.

Shutdown: The Port Security service is enabled by at least the Limit Control user module, and that module has indicated that the limit is exceeded. No MAC addresses can be learned on the port until it is administratively re-opened on the Limit Control configuration Web-page.

- **MAC Count (Current, Limit) :**

The two columns indicate the number of currently learned MAC addresses (forwarding as well as blocked) and the maximum number of MAC addresses that can be learned on the port, respectively.

If no user modules are enabled on the port, the Current column will show a dash (-).

If the Limit Control user module is not enabled on the port, the Limit column will show a dash (-).

Indicates the number of currently learned MAC addresses (forwarding as well as blocked) on the port. If no user modules are enabled on the port, a dash (-) will be shown.

- **Buttons**

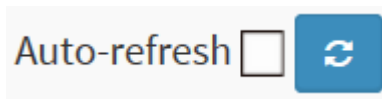

Auto-refresh: Check this box to refresh the page automatically. Automatic refresh occurs every 3 seconds.

Refresh: Click to refresh the page.

4-5.1.1.2 Port

This section shows the MAC addresses secured by the Port Security module. Port Security is a module with no direct configuration. Configuration comes indirectly from other modules - the user modules. When a user module has enabled port security on a port, the port is set-up for software-based learning. In this mode, frames from unknown MAC addresses are passed on to the port security module, which in turn asks all user modules whether to allow this new MAC address to forward or block it. For a MAC address to be set in the forwarding state, all enabled user modules must unanimously agree on allowing the MAC address to forward. If only one chooses to block it, it will be blocked until that user module decides otherwise.

Web Interface



To configure a Port Security Switch Status Configuration in the web interface:

1. Click Security, Network, Port Security, then Port.
2. Specify the Port which you want to monitor.
3. Checked "Auto-refresh".
4. Click " Refresh " to refresh the port detailed statistics.

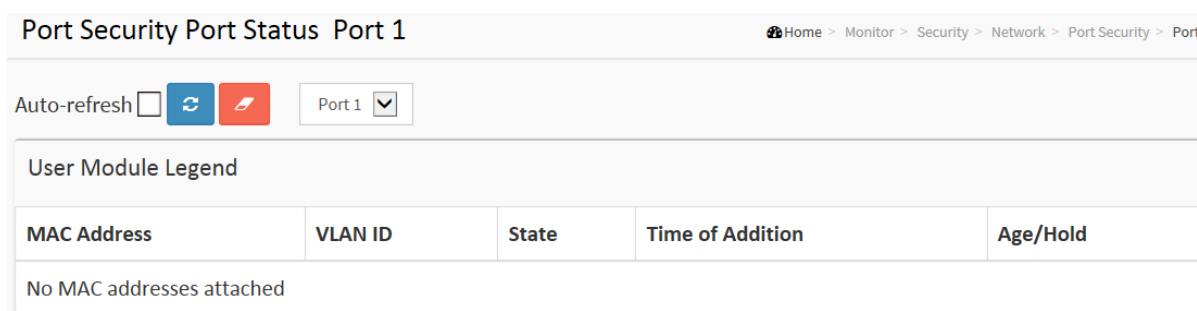
Figure 4-5.1.1.2: The Port Security Port Status



Port Security Port Status Port 1 Home > Monitor > Security > Network > Port Security > Port

Auto-refresh   Port 1 ▼

User Module Legend				
MAC Address	VLAN ID	State	Time of Addition	Age/Hold
No MAC addresses attached				

Parameter description:

- **MAC Address & VLAN ID :**

The MAC address and VLAN ID that is seen on this port. If no MAC addresses are learned, a single row stating "No MAC addresses attached" is displayed.

- **State :**

Indicates whether the corresponding MAC address is blocked or forwarding. In the blocked state, it will not be allowed to transmit or receive traffic.

- **Time of Addition :**



Shows the date and time when this MAC address was first seen on the port.

- **Age/Hold :**

If at least one user module has decided to block this MAC address, it will stay in the blocked state until the hold time (measured in seconds) expires. If all user modules have decided to allow this MAC address to forward, and aging is enabled, the Port Security module will periodically check that this MAC address still forwards traffic. If the age period (measured in seconds) expires and no frames have been seen, the MAC address will be removed from the MAC table. Otherwise a new age period will begin.

If aging is disabled or a user module has decided to hold the MAC address indefinitely, a dash (-) will be shown.

- **Buttons**

Auto-refresh   Port 1 

Auto-refresh: Check this box to refresh the page automatically. Automatic refresh occurs every 3 seconds.

Refresh: Click to refresh the page.

4-5.1.2 NAS

4-5.2.1.1 Switch

The section describes to show the each port NAS status information of the switch. The status includes Admin State Port State, Last Source, Last ID, QoS Class, and Port VLAN ID.

Web Interface

To configure a NAS Switch Status Configuration in the web interface:

1. Click Security, Network, NAS, then Port.
2. Checked "Auto-refresh".
3. Click "Refresh" to refresh the port detailed statistics.

Figure 4-5.2.2.1: The Network Access Server Switch Status

Network Access Server Switch Status Home > Monitor > Security > Network > NAS > Switch

Auto-refresh 

Port	Admin State	Port State	Last Source	Last ID	QoS Class	Port VLAN ID
1	Force Authorized	Globally Disabled			-	
2	Force Authorized	Globally Disabled			-	
3	Force Authorized	Globally Disabled			-	
4	Force Authorized	Globally Disabled			-	
5	Force Authorized	Globally Disabled			-	
23	Force Authorized	Globally Disabled			-	
24	Force Authorized	Globally Disabled			-	
25	Force Authorized	Globally Disabled			-	
26	Force Authorized	Globally Disabled			-	

Parameter description:

- **Port :**
The switch port number. Click to navigate to detailed NAS statistics for this port.
- **Admin State :**
The port's current administrative state. Refer to NAS Admin State for a description of possible values.
- **Port State :**
The current state of the port. Refer to NAS Port State for a description of the individual states.
- **Last Source :**
The source MAC address carried in the most recently received EAPOL frame for EAPOL-based authentication, and the most recently received frame from a new client for MAC-based authentication.
- **Last ID :**
The user name (supplicant identity) carried in the most recently received Response Identity

EAPOL frame for EAPOL-based authentication, and the source MAC address from the most recently received frame from a new client for MAC-based authentication.

- **QoS Class :**

QoS Class assigned to the port by the RADIUS server if enabled.

- **Port VLAN ID :**

The VLAN ID that NAS has put the port in. The field is blank, if the Port VLAN ID is not overridden by NAS.

If the VLAN ID is assigned by the RADIUS server, "(RADIUS-assigned)" is appended to the VLAN ID. Read more about RADIUS-assigned VLANs here.

If the port is moved to the Guest VLAN, "(Guest)" is appended to the VLAN ID. Read more about Guest VLANs here.

- **Buttons**

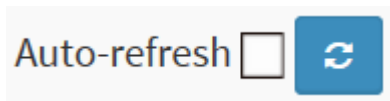

Auto-refresh: Check this box to refresh the page automatically. Automatic refresh occurs every 3 seconds.

Refresh: Click to refresh the page.

4-5.2.1.2 Port

The section describes to provides detailed NAS statistics for a specific switch port running EAPOL-based IEEE 802.1X authentication. For MAC-based ports, it shows selected backend server (RADIUS Authentication Server) statistics, only.

Web Interface

To configure a NAS Port Status Configuration in the web interface:

1. Click Security, Network, NAS, then Port.
2. Checked "Auto-refresh".
3. Click "Refresh" to refresh the port detailed statistics.

Figure 4-5.2.1.2: The NAS Statistics

NAS Statistics Port 1 Home > Monitor > Security > Network > NAS > Port

Auto-refresh  Port 1

Port State	
Admin State	Force Authorized
Port State	Globally Disabled

Parameter description:

Port State

- **Admin State :**
The port's current administrative state. Refer to NAS Admin State for a description of possible values.
- **Port State :**
The current state of the port. Refer to NAS Port State for a description of the individual states.
- **QoS Class :**
The QoS class assigned by the RADIUS server. The field is blank if no QoS class is assigned.
- **Port VLAN ID :**
The VLAN ID that NAS has put the port in. The field is blank, if the Port VLAN ID is not overridden by NAS.
If the VLAN ID is assigned by the RADIUS server, "(RADIUS-assigned)" is appended to the VLAN ID. Read more about RADIUS-assigned VLANs here.
If the port is moved to the Guest VLAN, "(Guest)" is appended to the VLAN ID. Read more about Guest VLANs here.

Port Counters

- **EAPOL Counters :**
These supplicant frame counters are available for the following administrative states:
 - Force Authorized
 - Force Unauthorized
 - Port-based 802.1X

- Single 802.1X
- Multi 802.1X

- **Backend Server Counters :**

These backend (RADIUS) frame counters are available for the following administrative states:

- Port-based 802.1X
- Single 802.1X
- Multi 802.1X
- MAC-based Auth.

- **Last Supplicant/Client Info :**

Information about the last supplicant/client that attempted to authenticate. This information is available for the following administrative states:

- Port-based 802.1X
- Single 802.1X
- Multi 802.1X
- MAC-based Auth.

Selected Counters

- **Selected Counters :**

The Selected Counters table is visible when the port is in one of the following administrative states:

- Multi 802.1X
- MAC-based Auth.

The table is identical to and is placed next to the Port Counters table, and will be empty if no MAC address is currently selected. To populate the table, select one of the attached MAC Addresses from the table below.

Attached MAC Addresses

- **Identity :**

Shows the identity of the supplicant, as received in the Response Identity EAPOL frame. Clicking the link causes the supplicant's EAPOL and Backend Server counters to be shown in the Selected Counters table. If no supplicants are attached, it shows No supplicants attached.

This column is not available for MAC-based Auth.

- **MAC Address :**

For Multi 802.1X, this column holds the MAC address of the attached supplicant. For MAC-based Auth., this column holds the MAC address of the attached client.

Clicking the link causes the client's Backend Server counters to be shown in the Selected Counters table. If no clients are attached, it shows No clients attached.

- **VLAN ID**

This column holds the VLAN ID that the corresponding client is currently secured through the Port Security module.

- **State :**

The client can either be authenticated or unauthenticated. In the authenticated state, it is allowed to forward frames on the port, and in the unauthenticated state, it is blocked. As long as the backend server hasn't successfully authenticated the client, it is unauthenticated. If an authentication fails for one or the other reason, the client will remain in the unauthenticated state for Hold Time seconds.

- **Last Authentication :**

Shows the date and time of the last authentication of the client (successful as well as unsuccessful).

- **Buttons**

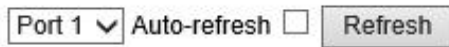

Auto-refresh: Check this box to refresh the page automatically. Automatic refresh occurs every 3 seconds.

Refresh: Click to refresh the page.

Clear: This button is available in the following modes:

- Force Authorized
- Force Unauthorized
- Port-based 802.1X
- Single 802.1X

Clear All: Click to clear the counters for the selected port.

This button is available in the following modes:

- Multi 802.1X
- MAC-based Auth.X

Clear This: Click to clear both the port counters and all of the attached client's counters. The "Last Client" will not be cleared, however.

This button is available in the following modes:

- Multi 802.1X
- MAC-based Auth.X

Click to clear only the currently selected client's counters.

4-5.1.3 ACL Status

The section describes how to shows the ACL status by different ACL users. Each row describes the ACE that is defined. It is a conflict if a specific ACE is not applied to the hardware due to hardware limitations. The maximum number of ACEs is 512 on each switch.

Web Interface

To display the ACL status in the web interface:

1. Click Monitor, Network, and then ACL status
2. If you want to auto-refresh the information then you need to evoke the “Auto-refresh”.
3. Click “Refresh” to refresh the ACL Status

Figure 4-5.1.3: The ACL Rate Limiter Configuration

ACL Status Home > Monitor > Security > Network > ACL Status

Auto-refresh  Combined

User	Ingress Port	Frame Type	Action	Rate Limiter	Port Redirect	Mirror	CPU	CPU Once	Counter	Conflict
DRM CLIENT	All	IPv4/UDP 10002	Permit	Disabled	Disabled	Disabled	Yes	No	0	No

Parameter description:

- **User :**
Indicates the ACL user.
- **Ingress Port :**
Indicates the ingress port of the ACE. Possible values are:
All: The ACE will match any ingress port.
Port: The ACE will match a specific ingress port.
- **Frame Type :**
Indicates the frame type of the ACE. Possible values are:
Any: The ACE will match any frame type.
EType: The ACE will match Ethernet Type frames. Note that an Ethernet Type based ACE will not get matched by IP and ARP frames.
ARP: The ACE will match ARP/RARP frames.
IPv4: The ACE will match all IPv4 frames.
IPv4: The ACE will match all IPv4 frames.
IPv4/ICMP: The ACE will match IPv4 frames with ICMP protocol.
IPv4/UDP: The ACE will match IPv4 frames with UDP protocol.
IPv4/TCP: The ACE will match IPv4 frames with TCP protocol.
IPv4/Other: The ACE will match IPv4 frames, which are not ICMP / UDP / TCP.
IPv6: The ACE will match all IPv6 standard frames.

- **Action :**
Indicates the forwarding action of the ACE.
Permit: Frames matching the ACE may be forwarded and learned.
Deny: Frames matching the ACE are dropped.
Filter: Frames matching the ACE are filtered.
- **Rate Limiter :**
Indicates the rate limiter number of the ACE. The allowed range is 1 to 16. When Disabled is displayed, the rate limiter operation is disabled.
- **Port Redirect :**
Indicates the port copy operation of the ACE. Frames matching the ACE are copied to the port number. The allowed values are Disabled or a specific port number. When Disabled is displayed, the port copy operation is disabled.
- **Mirror :**
Specify the mirror operation of this port. The allowed values are:
Enabled: Frames received on the port are mirrored.
Disabled: Frames received on the port are not mirrored.
The default value is "Disabled".
- **CPU :**
Forward packet that matched the specific ACE to CPU.
- **CPU Once :**
Forward first packet that matched the specific ACE to CPU.
- **Counter :**
The counter indicates the number of times the ACE was hit by a frame.
- **Conflict :**
Indicates the hardware status of the specific ACE. The specific ACE is not applied to the hardware due to hardware limitations.

- **Buttons**



Auto-refresh: Check this box to refresh the page automatically. Automatic refresh occurs every 3 seconds.

Refresh: Click to refresh the page.

4-5.1.3 ARP Inspection

The section describes to configure the Dynamic ARP Inspection Table parameters of the switch. The Dynamic ARP Inspection Table contains up to 1024 entries, and is sorted first by port, then by VLAN ID, then by MAC address, and then by IP address.

Web Interface

To configure a Dynamic ARP Inspection Table Configuration in the web interface:

1. Click Security, Network, ARP Inspection.
2. Checked "Auto-refresh".
3. Click "Refresh" to refresh the port detailed statistics.
4. Specify the Start from port, VLAN ID, MAC Address, IP Address, and entries per page.

Figure 4-5.1.3: The Dynamic ARP Inspection Table

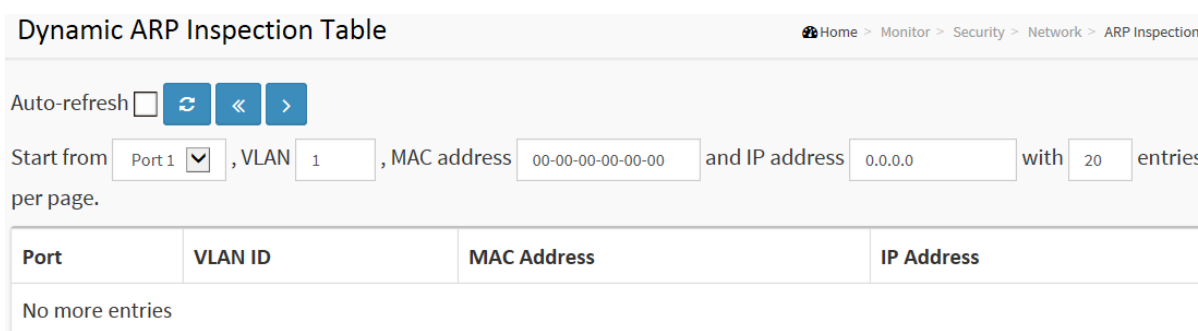

Parameter description:

Navigating the ARP Inspection Table :

Each page shows up to 99 entries from the Dynamic ARP Inspection table, default being 20, selected through the "entries per page" input field. When first visited, the web page will show the first 20 entries from the beginning of the Dynamic ARP Inspection Table.

The "Start from port address", "VLAN", "MAC address" and "IP address" input fields allow the user to select the starting point in the Dynamic ARP Inspection Table. Clicking the button will update the displayed table starting from that or the closest next Dynamic ARP Inspection Table match. In addition, the two input fields will - upon a button click - assume the value of the first displayed entry, allowing for continuous refresh with the same start address.

The will use the last entry of the currently displayed table as a basis for the next lookup. When the end is reached the text "No more entries" is shown in the displayed table. Use the button to start over.

- **Port :**
Switch Port Number for which the entries are displayed.
- **VLAN ID :**
VLAN-ID in which the ARP traffic is permitted.
- **MAC Address :**
User MAC address of the entry.
- **IP Address :**
User IP address of the entry.
- **Buttons**



Auto-refresh: Check this box to refresh the page automatically. Automatic refresh occurs every 3 seconds.

Refresh: Click to refresh the page.

|<<: Updates the system log entries to the first available entry ID.

>> : Updates the system log entry to the next available entry ID.

4-5.1.4 IP Source Guard

Entries in the Dynamic IP Source Guard Table are shown on this page. The Dynamic IP Source Guard Table is sorted first by port, then by VLAN ID, then by IP address, and then by MAC address.

Web Interface

To configure a Dynamic IP Source Guard Table Configuration in the web interface:

1. Click Security, Network, IP Source Guard.
2. Checked "Auto-refresh".
3. Click "Refresh" to refresh the port detailed statistics.
4. Specify the Start from port, VLAN ID, IP Address, and entries per page.

Figure 4-5.1.4: The Dynamic IP Source Table

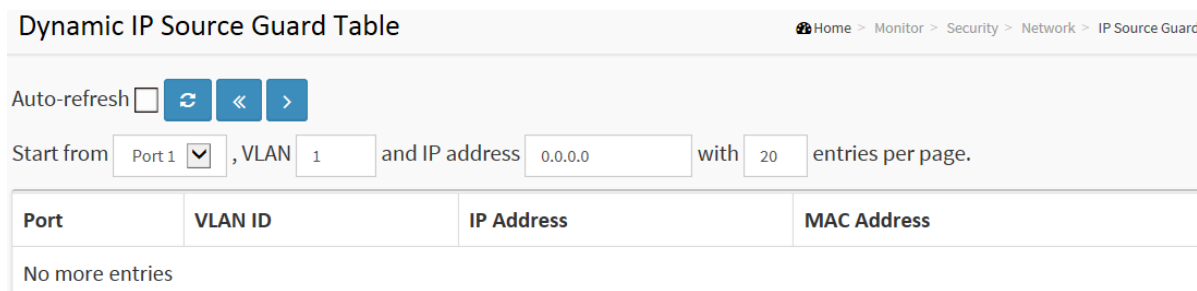

Parameter description:

- **Port :**
Switch Port Number for which the entries are displayed.
- **VLAN ID :**
VLAN-ID in which the IP traffic is permitted.
- **IP Address :**
User IP address of the entry.
- **MAC Address :**
Source MAC address.
- **Buttons**



Auto-refresh: Check this box to refresh the page automatically. Automatic refresh occurs every 3 seconds.

Refresh: Click to refresh the page.

|<<: Updates the system log entries to the first available entry ID.

>> : Updates the system log entry to the next available entry ID.

4-5.2 AAA

4-5.2.1 RADIUS Overview

This section shows you an overview of the RADIUS Authentication and Accounting servers status to ensure the function is workable.

Web Interface

To configure a RADIUS Overview Configuration in the web interface:

1. Click Security, AAA, then RADIUS Overview.
2. Checked “Auto-refresh”.
3. Click “ Refresh” to refresh the port detailed statistics.

Figure 4-5.2.1: The RADIUS Authentication Server Status Overview

RADIUS Server Status Overview		
Home > Monitor > Security > AAA > RADIUS Overview		
RADIUS Authentication Server Status Overview		
#	IP Address	Status
1	0.0.0.0:0	Disabled
2	0.0.0.0:0	Disabled
3	0.0.0.0:0	Disabled
4	0.0.0.0:0	Disabled
5	0.0.0.0:0	Disabled
RADIUS Authentication Server Status Overview		
#	IP Address	Status
1	0.0.0.0:0	Disabled
2	0.0.0.0:0	Disabled
3	0.0.0.0:0	Disabled
4	0.0.0.0:0	Disabled
5	0.0.0.0:0	Disabled

Parameter description:

- **# :**
The RADIUS server number. Click to navigate to detailed statistics for this server.
- **IP Address :**
The IP address and UDP port number (in <IP Address>:<UDP Port> notation) of this server.
- **State :**
The current state of the server. This field takes one of the following values:
Disabled: The server is disabled.

Not Ready: The server is enabled, but IP communication is not yet up and running.

Ready: The server is enabled, IP communication is up and running, and the RADIUS module is ready to accept access attempts.

Dead (X seconds left): Access attempts were made to this server, but it did not reply within the configured timeout. The server has temporarily been disabled, but will get re-enabled when the dead-time expires. The number of seconds left before this occurs is displayed in parentheses. This state is only reachable when more than one server is enabled.

RADIUS Accounting Servers

- **# :**

The RADIUS server number. Click to navigate to detailed statistics for this server.

- **IP Address :**

The IP address and UDP port number (in <IP Address>:<UDP Port> notation) of this server.

- **State :**

The current state of the server. This field takes one of the following values:

Disabled: The server is disabled.

Not Ready: The server is enabled, but IP communication is not yet up and running.

Ready: The server is enabled, IP communication is up and running, and the RADIUS module is ready to accept accounting attempts.

Dead (X seconds left): Accounting attempts were made to this server, but it did not reply within the configured timeout. The server has temporarily been disabled, but will get re-enabled when the dead-time expires. The number of seconds left before this occurs is displayed in parentheses. This state is only reachable when more than one server is enabled.

4-5.2.2 RADIUS Details

This section shows you an detailed statistics for a particular RADIUS server.

Web Interface

To configure a RADIUS Details Configuration in the web interface:

1. Specify Port which want to check.
2. Click Security, AAA, then RADIUS Overview.
3. Checked "Auto-refresh".
4. Click " Refresh" to refresh the port detailed statistics or clear all information when you click " Clear".fresh".

Figure 4-5.2.2: The RADIUS Authentication Statistics Server

RADIUS Authentication Statistics
Home > Monitor > Security > AAA > RADIUS Details

Auto-refresh
Server #1 ▼

RADIUS Authentication Statistics for Server #1

Receive Packets		Transmit Packets	
Access Accepts	0	Access Requests	0
Access Rejects	0	Access Retransmissions	0
Access Challenges	0	Pending Requests	0
Malformed Access Responses	0	Timeouts	0
Bad Authenticators	0		
Unknown Types	0		
Packets Dropped	0		

Other Info

IP Address	0.0.0.0:0
State	Disabled
Round-Trip Time	0 ms

RADIUS Accounting Statistics for Server #1			
Receive Packets		Transmit Packets	
Responses	0	Requests	0
Malformed Responses	0	Retransmissions	0
Bad Authenticators	0	Pending Requests	0
Unknown Types	0	Timeouts	0
Packets Dropped	0		
Other Info			
IP Address	0.0.0.0:0		
State	Disabled		
Round-Trip Time	0 ms		

Parameter description:

RADIUS Authentication Statistics

The statistics map closely to those specified in RFC4668 - RADIUS Authentication Client MIB. Use the server select box to switch between the backend servers to show details for.

Packet Counters

RADIUS authentication server packet counter. There are seven receive and four transmit counters.

Direction	Name	RFC4668 Name	Description
Rx	Access Accepts	radiusAuthClientExtAccessAccepts	The number of RADIUS Access-Accept packets (valid or invalid) received from the server.
Rx	Access Rejects	radiusAuthClientExtAccessRejects	The number of RADIUS Access-Reject packets (valid or invalid) received from the server.
Rx	Access Challenges	radiusAuthClientExtAccessChallenges	The number of RADIUS Access-Challenge packets (valid or invalid) received from the server.
Rx	Malformed Access Responses	radiusAuthClientExtMalformedAccessResponses	The number of malformed RADIUS Access-Response packets received from the server. Malformed packets include packets with an invalid length. Bad authenticators or Message Authenticator attributes or unknown types are not included as malformed access responses.
Rx	Bad Authenticators	radiusAuthClientExtBadAuthenticators	The number of RADIUS Access-Response packets containing invalid authenticators or Message Authenticator attributes received from the server.
Rx	Unknown Types	radiusAuthClientExtUnknownTypes	The number of RADIUS packets that were received with unknown types from the server on the authentication port and dropped.
Rx	Packets Dropped	radiusAuthClientExtPacketsDropped	The number of RADIUS packets that were received from the server on the authentication port and dropped for some other reason.
Tx	Access Requests	radiusAuthClientExtAccessRequests	The number of RADIUS Access-Request packets sent to the server. This does not

			include retransmissions.
Tx	Access Retransmissions	radiusAuthClientExtAccessRetransmissions	The number of RADIUS Access-Request packets retransmitted to the RADIUS authentication server.
Tx	Pending Requests	radiusAuthClientExtPendingRequests	The number of RADIUS Access-Request packets destined for the server that have not yet timed out or received a response. This variable is incremented when an Access-Request is sent and decremented due to receipt of an Access-Accept, Access-Reject, Access-Challenge, timeout, or retransmission.
Tx	Timeouts	radiusAuthClientExtTimeouts	The number of authentication timeouts to the server. After a timeout, the client may retry to the same server, send to a different server, or give up. A retry to the same server is counted as a retransmit as well as a timeout. A send to a different server is counted as a Request as well as a timeout.

Other Info

This section contains information about the state of the server and the latest round-trip time.

Name	RFC4668 Name	Description
IP Address	-	IP address and UDP port for the authentication server in question.
State	-	Shows the state of the server. It takes one of the following values: Disabled: The selected server is disabled. Not Ready: The server is enabled, but IP communication is not yet up and running. Ready: The server is enabled, IP communication is up and running, and the RADIUS module is ready to accept access attempts. Dead (X seconds left): Access attempts were made to this server, but it did not reply within the configured timeout. The server has temporarily been disabled, but will get re-enabled when the dead-time expires. The number of seconds left before this occurs is displayed in parentheses. This state is only reachable when more than one server is enabled.
Round-Trip Time	radiusAuthClientExtRoundTripTime	The time interval (measured in milliseconds) between the most recent Access-Reply/Access-Challenge and the Access-Request that matched it from the RADIUS authentication server. The granularity of this measurement is 100 ms. A value of 0 ms indicates that there hasn't been round-trip communication with the server yet.

RADIUS Accounting Statistics

The statistics map closely to those specified in RFC4670 - RADIUS Accounting Client MIB. Use the server select box to switch between the backend servers to show details for.

Packet Counters

RADIUS accounting server packet counter. There are five receive and four transmit counters.

Direction	Name	RFC4670 Name	Description
Rx	Responses	radiusAccClientExtResponses	The number of RADIUS packets (valid or invalid) received from the server.
Rx	Malformed	radiusAccClientExtMalformed	The number of malformed RADIUS

	Responses	Responses	packets received from the server. Malformed packets include packets with an invalid length. Bad authenticators or unknown types are not included as malformed access responses.
Rx	Bad Authenticators	radiusAcctClientExtBadAuthenticators	The number of RADIUS packets containing invalid authenticators received from the server.
Rx	Unknown Types	radiusAccClientExtUnknownTypes	The number of RADIUS packets of unknown types that were received from the server on the accounting port.
Rx	Packets Dropped	radiusAccClientExtPacketsDropped	The number of RADIUS packets that were received from the server on the accounting port and dropped for some other reason.
Tx	Requests	radiusAccClientExtRequests	The number of RADIUS packets sent to the server. This does not include retransmissions.
Tx	Retransmissions	radiusAccClientExtRetransmissions	The number of RADIUS packets retransmitted to the RADIUS accounting server.
Tx	Pending Requests	radiusAccClientExtPendingRequests	The number of RADIUS packets destined for the server that have not yet timed out or received a response. This variable is incremented when a Request is sent and decremented due to receipt of a Response, timeout, or retransmission.
Tx	Timeouts	radiusAccClientExtTimeouts	The number of accounting timeouts to the server. After a timeout, the client may retry to the same server, send to a different server, or give up. A retry to the same server is counted as a retransmit as well as a timeout. A send to a different server is counted as a Request as well as a timeout.

Other Info

This section contains information about the state of the server and the latest round-trip time.

Name	RFC4670 Name	Description
IP Address	-	IP address and UDP port for the accounting server in question.
State	-	Shows the state of the server. It takes one of the following values: Disabled: The selected server is disabled. Not Ready: The server is enabled, but IP communication is not yet up and running. Ready: The server is enabled, IP communication is up and running, and the RADIUS module is ready to accept accounting attempts. Dead (X seconds left): Accounting attempts were made to this server, but it did not reply within the configured timeout. The server has temporarily been disabled, but will get re-enabled when the dead-time expires. The number of seconds left before this occurs is displayed in parentheses. This state is only reachable when more than one server is enabled.
Round-Trip	radiusAccClientExtRoundTripTime	The time interval (measured in milliseconds) between

Time		the most recent Response and the Request that matched it from the RADIUS accounting server. The granularity of this measurement is 100 ms. A value of 0 ms indicates that there hasn't been round-trip communication with the server yet.
-------------	--	---

- **Buttons:**

Auto-refresh –Check this box to enable an automatic refresh of the page at regular intervals.

Refresh - Click to refresh the page immediately.

Clear - Clears the counters for the selected server. The "Pending Requests" counter will not be cleared by this operation.

4-5.3 Switch

4-5.3.1 RMON

4-5.3.1.1 Statistics

This section provides an overview of RMON Statistics entries. Each page shows up to 99 entries from the Statistics table, default being 20, selected through the "entries per page" input field. When first visited, the web page will show the first 20 entries from the beginning of the Statistics table. The first displayed will be the one with the lowest ID found in the Statistics table.

The "Start from Control Index" allows the user to select the starting point in the Statistics table. Clicking the button will update the displayed table starting from that or the next closest Statistics table match.

The will use the last entry of the currently displayed entry as a basis for the next lookup. When the end is reached the text "No more entries" is shown in the displayed table. Use the button to start over.

Web Interface

To configure a RMON Statistics in the web interface:

1. Specify Port which want to check.
2. Click Security, Switch, RMON ,then Statistics.
3. Checked "Auto-refresh".
4. Click " Refresh" to refresh the port detailed statistics.

Figure 4-5.3.1.1: The RMON Statistics Status Overview

RMON Statistics Status Overview Home > Monitor > Security > Switch > RMON > Statistics

Auto-refresh ↺ ↻ ↷

Start from Control Index with entries per page.

ID	Data Source (ifIndex)	Drop	Octets	Pkts	Broad-cast	Multi-cast	CRC Errors	Under-size	Over-size	Frag.	Jabb.	Coll.	Bytes	65 ~ 127	128 ~ 255	256 ~ 511	512 ~ 1023	1024 ~ 1588
No more entries																		

Parameter description:

- **ID**
Indicates the index of Statistics entry.
- **Data Source(ifIndex)**
The port ID which wants to be monitored.
- **Drop**
The total number of events in which packets were dropped by the probe due to lack of resources.
- **Octets**
The total number of octets of data (including those in bad packets) received on the network.
- **Pkts**
The total number of packets (including bad packets, broadcast packets, and multicast packets) received.
- **Broad-cast**

The total number of good packets received that were directed to the broadcast address.

- **Multi-cast**

The total number of good packets received that were directed to a multicast address.

- **CRC Errors**

The total number of packets received that had a length (excluding framing bits, but including FCS octets) of between 64 and 1518 octets, inclusive, but had either a bad Frame Check Sequence (FCS) with an integral number of octets (FCS Error) or a bad FCS with a non-integral number of octets (Alignment Error).

- **Under-size**

The total number of packets received that were less than 64 octets.

- **Over-size**

The total number of packets received that were longer than 1518 octets.

- **Frag.**

The number of frames which size is less than 64 octets received with invalid CRC.

- **Jabb.**

The number of frames which size is larger than 64 octets received with invalid CRC.

- **Coll.**

The best estimate of the total number of collisions on this Ethernet segment.

- **64**

The total number of packets (including bad packets) received that were 64 octets in length.

- **65~127**

The total number of packets (including bad packets) received that were between 65 to 127 octets in length.

- **128~255**

The total number of packets (including bad packets) received that were between 128 to 255 octets in length.

- **256~511**

The total number of packets (including bad packets) received that were between 256 to 511 octets in length.

- **512~1023**

The total number of packets (including bad packets) received that were between 512 to 1023 octets in length.

- **1024~1588**

The total number of packets (including bad packets) received that were between 1024 to 1588 octets in length.

- **Buttons**



Auto-refresh: Check this box to refresh the page automatically. Automatic refresh occurs every 3 seconds.

Refresh: Click to refresh the page immediately.

<< : Updates the table starting from the first entry in the Statistics table, i.e. the entry with the lowest ID.

>> : Updates the table, starting with the entry after the last entry currently displayed.

4-5.3.1.2 History

This section provides an overview of RMON History entries. Each page shows up to 99 entries from the History table, default being 20, selected through the "entries per page" input field. When first visited, the web page will show the first 20 entries from the beginning of the History table. The first displayed will be the one with the lowest History Index and Sample Index found in the History table.

The "Start from History Index and Sample Index" allows the user to select the starting point in the History table.

The "Start from History Index and Sample Index" allows the user to select the starting point in the History table. Clicking the button will update the displayed table starting from that or the next closest History table match.

The will use the last entry of the currently displayed entry as a basis for the next lookup. When the end is reached the text "No more entries" is shown in the displayed table. Use the button to start over.

Web Interface

To configure a RMON history Configuration in the web interface:

1. Specify Port which wants to check.
2. Click Security, Switch, RMON ,then History.
3. Checked "Auto-refresh".
4. Click " Refresh" to refresh the port detailed statistics or clear all information when you click " Clear".

Figure 4-5.3.1.2: RMON History Overview

RMON History Overview Home > Monitor > Security > Switch > RMON > History

Auto-refresh ↺ ↻ ↷

Start from Control Index and Sample Index with entries per page.

History Index	Sample Index	Sample Start	Drop	Octets	Pkts	Broad-cast	Multi-cast	CRC Errors	Under-size	Over-size	Frag.	Jabb.	Coll.	Utilization
No more entries														

Parameter description:

- **History Index**

Indicates the index of History control entry.

- **Sample Index**

Indicates the index of the data entry associated with the control entry.

- **Sample Start**

The value of sysUpTime at the start of the interval over which this sample was measured.

- **Drop**

The total number of events in which packets were dropped by the probe due to lack of resources.

- **Octets**

The total number of octets of data (including those in bad packets) received on the network.

- **Pkts**

The total number of packets (including bad packets, broadcast packets, and multicast

packets) received.

- **Broadcast**

The total number of good packets received that were directed to the broadcast address.

- **Multicast**

The total number of good packets received that were directed to a multicast address.

- **CRCErrors**

The total number of packets received that had a length (excluding framing bits, but including FCS octets) of between 64 and 1518 octets, inclusive, but had either a bad Frame Check Sequence (FCS) with an integral number of octets (FCS Error) or a bad FCS with a non-integral number of octets (Alignment Error).

- **Undersize**

The total number of packets received that were less than 64 octets.

- **Oversize**

The total number of packets received that were longer than 1518 octets.

- **Frag.**

The number of frames which size is less than 64 octets received with invalid CRC.

- **Jabb.**

The number of frames which size is larger than 64 octets received with invalid CRC.

- **Coll.**

The best estimate of the total number of collisions on this Ethernet segment.

- **Utilization**

The best estimate of the mean physical layer network utilization on this interface during this sampling interval, in hundredths of a percent.

- **Buttons**



Auto-refresh: Check this box to refresh the page automatically. Automatic refresh occurs every 3 seconds.

Refresh: Click to refresh the page immediately.

|<< : Updates the table starting from the first entry in the History table, i.e., the entry with the lowest History Index and Sample Index

>> : Updates the table, starting with the entry after the last entry currently displayed

4-5.3.1.3 Alarm

This page provides an overview of RMON Alarm entries. Each page shows up to 99 entries from the Alarm table, default being 20, selected through the "entries per page" input field. When first visited, the web page will show the first 20 entries from the beginning of the Alarm table. The first displayed will be the one with the lowest ID found in the Alarm table.

The "Start from Control Index" allows the user to select the starting point in the Alarm table.

Clicking the button will update the displayed table starting from that or the next closest Alarm table match.

The will use the last entry of the currently displayed entry as a basis for the next lookup. When the end is reached the text "No more entries" is shown in the displayed table. Use the button to start over.

Web Interface

To configure a RMON Alarm Overview in the web interface:

1. Specify Port which wants to check.
2. Click Security, Switch, RMON ,then Alarm.
3. Checked "Auto-refresh".
4. Click " Refresh" to refresh the port detailed statistics.

Figure 4-5.3.1.3: RMON Alarm Overview

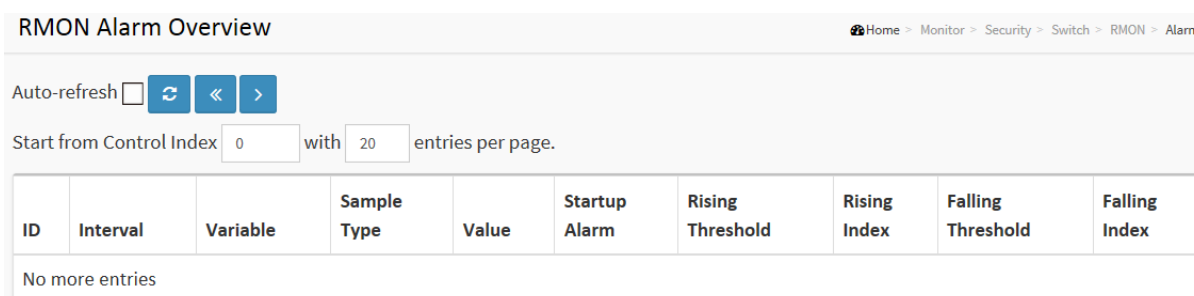

Parameter description:

- **ID**
Indicates the index of Alarm control entry.
- **Interval**
Indicates the interval in seconds for sampling and comparing the rising and falling threshold.
- **Variable**
Indicates the particular variable to be sampled
- **Sample Type**
The method of sampling the selected variable and calculating the value to be compared against the thresholds.
- **Value**
The value of the statistic during the last sampling period.
- **Startup Alarm**
The alarm that may be sent when this entry is first set to valid.
- **Rising Threshold**
Rising threshold value.

- **Rising Index**
Rising event index.
- **Falling Threshold**
Falling threshold value.
- **Falling Index**
Falling event index.

- **Buttons**



Auto-refresh: Check this box to refresh the page automatically. Automatic refresh occurs every 3 seconds.

Refresh: Click to refresh the page immediately.

|<<: Updates the table starting from the first entry in the Alarm Table, i.e. the entry with the lowest ID.

>> : Updates the table, starting with the entry after the last entry currently displayed.

4-5.3.1.4 Event

This page provides an overview of RMON Event table entries. Each page shows up to 99 entries from the Event table, default being 20, selected through the "entries per page" input field. When first visited, the web page will show the first 20 entries from the beginning of the Event table. The first displayed will be the one with the lowest Event Index and Log Index found in the Event table .

The "Start from Event Index and Log Index" allows the user to select the starting point in the Event table. Clicking the button will update the displayed table starting from that or the next closest Event table match.

The will use the last entry of the currently displayed entry as a basis for the next lookup. When the end is reached the text "No more entries" is shown in the displayed table. Use the button to start over.

Web Interface

To configure a RMON Event Overview in the web interface:

1. Click Security, Switch, RMON, then Event.
2. Checked "Auto-refresh".
3. Click " Refresh" to refresh the port detailed statistics
4. Specify Port which wants to check.

Figure 4-5.3.1.4: RMON Event Overview

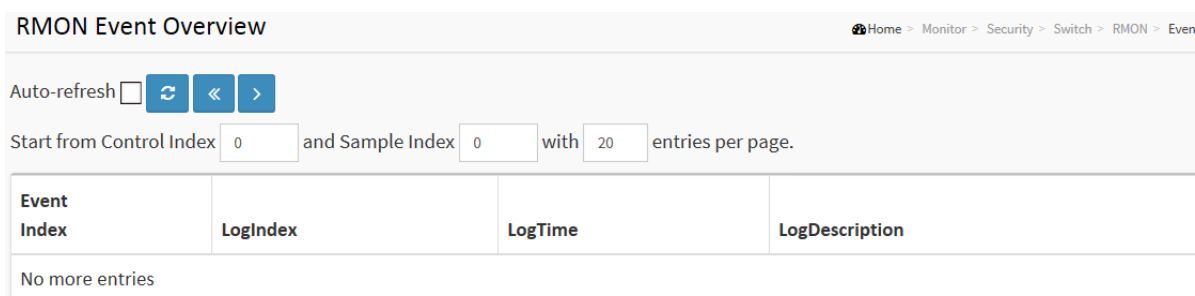

Parameter description:

- **Event Index**
Indicates the index of the event entry.
- **Log Index**
Indicates the index of the log entry.
- **LogTime**
Indicates Event log time
- **LogDescription**
Indicates the Event description.
- **Buttons**



Auto-refresh: Check this box to refresh the page automatically. Automatic refresh occurs every 3 seconds.

Refresh: Click to refresh the page immediately.

|<< : Updates the table starting from the first entry in the Event Table, i.e. the entry with the lowest Event Index and Log Index.

>>: Updates the table, starting with the entry after the last entry currently displayed

4-6 LACP

4-6.1 System Status

This section describes that when you complete to set LACP function on the switch then it provides a status overview for all LACP instances

Web Interface

To display the LACP System status in the web interface:

1. Click Monitor, LACP, System Status
2. Checked "Auto-refresh".
3. Click " Refresh" to refresh the port detailed statistics.

Figure 4-6.1 The LACP System Status

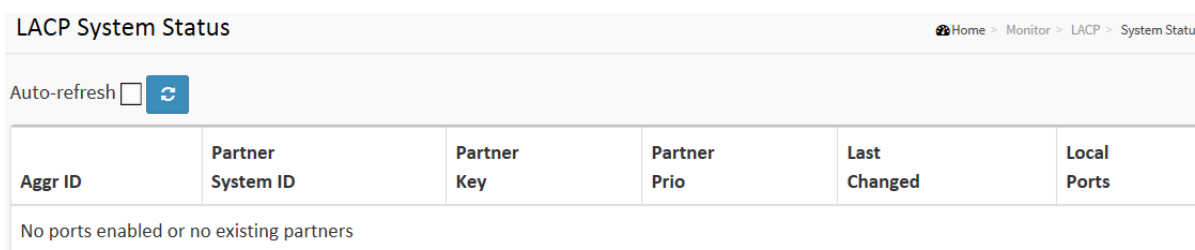

Aggr ID	Partner System ID	Partner Key	Partner Prio	Last Changed	Local Ports
No ports enabled or no existing partners					

Parameter description:

- **Aggr ID :**
The Aggregation ID associated with this aggregation instance. For LLAG the id is shown as 'isid: aggr-id' and for GLAGs as 'aggr-id'
- **Partner System ID :**
The system ID (MAC address) of the aggregation partner.
- **Partner Key :**
The Key that the partner has assigned to this aggregation ID.
- **Last changed :**
The time since this aggregation changed.
- **Local Ports :**
Shows which ports are a part of this aggregation for this switch. The format is: "Switch ID:Port".
- **Buttons**

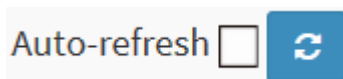

Auto-refresh: Check this box to refresh the page automatically. Automatic refresh occurs every 3 seconds.

Refresh: Click to refresh the page.

4-6.2 Port Status

This section describes that when you complete to set LACP function on the switch then it provides a Port Status overview for all LACP instances.

Web Interface

To display the LACP Port status in the web interface:

1. Click Monitor, LACP, Port Status
2. If you want to auto-refresh the information then you need to evoke the “Auto-refresh”.
3. Click “Refresh” to refresh the LACP Port Status.

Figure 4-6.2: The LACP Status

LACP Status Home > Monitor > LACP > Port Status

Auto-refresh 

Port	LACP	Key	Aggr ID	Partner System ID	Partner Port	Partner Prio
1	No	-	-	-	-	-
2	No	-	-	-	-	-
3	No	-	-	-	-	-
4	No	-	-	-	-	-
23	No	-	-	-	-	-
24	No	-	-	-	-	-
25	No	-	-	-	-	-
26	No	-	-	-	-	-

Parameter description:

- **Port :**

The switch port number.

- **LACP :**

'Yes' means that LACP is enabled and the port link is up. 'No' means that LACP is not enabled or that the port link is down. 'Backup' means that the port could not join the aggregation group but will join if other port leaves. Meanwhile it's LACP status is disabled.

- **Key :**

The key assigned to this port. Only ports with the same key can aggregate together.

- **Aggr ID :**

The Aggregation ID assigned to this aggregation group. IDs 1 and 2 are GLAGs while IDs 3-14 are LLAGs.

- **Partner System ID :**

The partner's System ID (MAC address).

- **Partner Port :**

The partner's port number connected to this port.

- **Partner Prio:**
The partner's port priority.
- **Buttons**

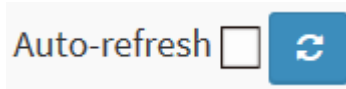

Auto-refresh: Check this box to refresh the page automatically. Automatic refresh occurs every 3 seconds.

Refresh: Click to refresh the page.

4-6.3 Port Statistics

This section describes that when you complete to set LACP function on the switch then it provides a Port Statistics overview for all LACP instances



Web Interface

To display the LACP Port status in the web interface:

1. Click Monitor, LACP, Port Statistics
2. If you want to auto-refresh the information then you need to evoke the “Auto refresh”.
3. 3. Click “ Refresh” to refresh the LACP Statistics.

Figure 4-6.3: The LACP Statistics

LACP Statistics Home > Monitor > LACP > Port Statistics

Auto-refresh  

Port	LACP Received	LACP Transmitted	Discarded	
			Unknown	Illegal
1	0	0	0	0
2	0	0	0	0
3	0	0	0	0
4	0	0	0	0
5	0	0	0	0
23	0	0	0	0
24	0	0	0	0
25	0	0	0	0
26	0	0	0	0

Parameter description:

- **Port :**
The switch port number.
- **LACP Received :**
Shows how many LACP frames have been received at each port.
- **LACP Transmitted :**
Shows how many LACP frames have been sent from each port.
- **Discarded :**
Shows how many unknown or illegal LACP frames have been discarded at each port.
- **Buttons**



Auto-refresh: Check this box to refresh the page automatically. Automatic refresh occurs every 3 seconds.

Clear: Clears the counters for the selected port.

Refresh: Click to refresh the page.

4-7 Loop Protection

This section displays the loop protection port status the ports of the currently selected switch.

Web Interface

To display the Loop Protection status in the web interface:

1. Click Monitor, Loop Protection
2. If you want to auto-refresh the information then you need to evoke the “Auto refresh”.
3. Click “ Refresh“ to refresh the LACP Statistics.

Figure 4-7: Loop Protection Status

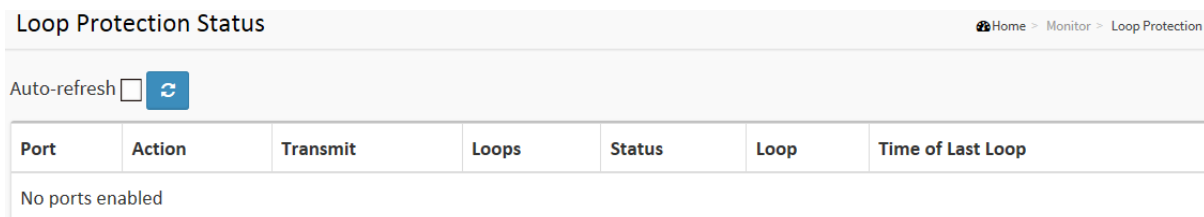

Port	Action	Transmit	Loops	Status	Loop	Time of Last Loop
No ports enabled						

Parameter description:

- **Port**
The switch port number of the logical port.
- **Action**
The currently configured port action.
- **Transmit**
The currently configured port transmit mode.
- **Loops**
The number of loops detected on this port.
- **Status**
The current loop protection status of the port.
- **Loop**
Whether a loop is currently detected on the port.
- **Time of Last Loop**
The time of the last loop event detected.
- **Buttons**

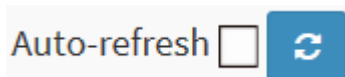

Refresh: Click to refresh the page immediately.

Auto-refresh: Check this box to enable an automatic refresh of the page at regular intervals.

4-8 Spanning Tree

4-8.1 Bridge Status

After you complete the MSTI Port configuration, you could ask the switch display the Bridge Status. The Section provides a status overview of all STP bridge instances. The displayed table contains a row for each STP bridge instance, where the column displays the following information:

Web Interface

To display the STP Bridges status in the web interface:

1. Click Monitor, Spanning Tree, STP Bridges
2. If you want to auto-refresh the information then you need to evoke the “Auto-refresh”.
3. Click “Refresh” to refresh the STP Bridges.
4. Click “CIST” to next page “STP Detailed Bridge Status”.

Figure 4-8.1: The STP Bridges status

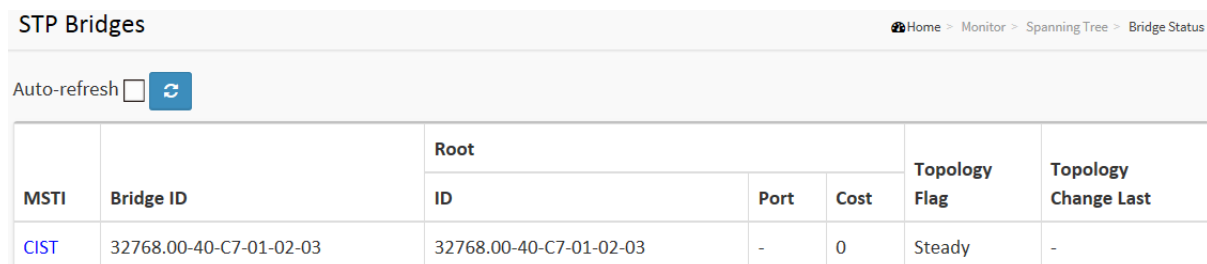

MSTI	Bridge ID	Root			Topology Flag	Topology Change Last
		ID	Port	Cost		
CIST	32768.00-40-C7-01-02-03	32768.00-40-C7-01-02-03	-	0	Steady	-

Parameter description:

- **MSTI :**
The Bridge Instance. This is also a link to the STP Detailed Bridge Status.
- **Bridge ID :**
The Bridge ID of this Bridge instance.
- **Root ID :**
The Bridge ID of the currently elected root bridge.
- **Root Port :**
The switch port currently assigned the root port role.
- **Root Cost :**
Root Path Cost. For the Root Bridge it is zero. For all other Bridges, it is the sum of the Port Path Costs on the least cost path to the Root Bridge.
- **Topology Flag :**
The current state of the Topology Change Flag of this Bridge instance.
- **Topology Change Last :**
The time since last Topology Change occurred.
- **Buttons**

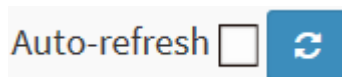

Auto-refresh: Check this box to refresh the page automatically. Automatic refresh occurs every 3 seconds.

Refresh: Click to refresh the page.

4-8.2 Port Status

After you complete the STP configuration the you could to ask the switch display the STP Port Status. The Section provides you to ask switch to display the STP CIST port status for physical ports of the currently selected switch:

Web Interface

To display the STP Port status in the web interface:

1. Click Monitor, Spanning Tree, STP Port Status
2. If you want to auto-refresh the information then you need to evoke the “Auto-refresh”.
3. Click “Refresh” to refresh the STP Bridges.

Figure 4-8.2: The STP Port status

STP Port Status Home > Monitor > Spanning Tree > Port Status

Auto-refresh 

Port	CIST Role	CIST State	Uptime
1	DesignatedPort	Forwarding	0d 04:16:47
2	Disabled	Discarding	-
3	Disabled	Discarding	-
4	Disabled	Discarding	-
5	Disabled	Discarding	-
6	Disabled	Discarding	-
22	Disabled	Discarding	-
23	Disabled	Discarding	-
24	Disabled	Discarding	-
25	Disabled	Discarding	-
26	Disabled	Discarding	-

Parameter description:

- **Port :**
The switch port number of the logical STP port.
- **CIST Role :**
The current STP port role of the CIST port. The port role can be one of the following values: AlternatePort, Backup Port, RootPort, DesignatedPort Disabled.
- **CIST State :**
The current STP port state of the CIST port. The port state can be one of the following values: Blocking Learning Forwarding.
- **Uptime**
The time since the bridge port was last initialized.
- **Buttons**

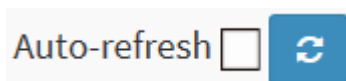

Auto-refresh: Check this box to refresh the page automatically. Automatic refresh occurs every 3 seconds.

Refresh: Click to refresh the page.

4-8.3 Port Statistics

After you complete the STP configuration then you could to let the switch display the STP Statistics. The Section provides you to ask switch to display the STP Statistics detail counters of bridge ports in the currently selected switch.

Web Interface

To display the STP Port status in the web interface:

1. Click Monitor, Spanning Tree, Port Statistics
2. If you want to auto-refresh the information then you need to evoke the “Auto-refresh”.
3. Click “ Refresh” to refresh the STP Bridges.

Figure 4-8.3: The STP Statistics

STP Statistics Home > Monitor > Spanning Tree > Port Statistics

Auto-refresh  

Port	Transmitted				Received				Discarded	
	MSTP	RSTP	STP	TCN	MSTP	RSTP	STP	TCN	Unknown	Illegal
1	7764	0	0	0	0	0	0	0	0	0

Parameter description:

- **Port :**
The switch port number of the logical STP port.
- **MSTP :**
The number of MSTP Configuration BPDU's received/transmitted on the port.
- **RSTP :**
The number of RSTP Configuration BPDU's received/transmitted on the port.
- **STP :**
The number of legacy STP Configuration BPDU's received/transmitted on the port.
- **TCN :**
The number of (legacy) Topology Change Notification BPDU's received/transmitted on the port.
- **Discarded Unknown :**
The number of unknown Spanning Tree BPDU's received (and discarded) on the port.
- **Discarded Illegal :**
The number of illegal Spanning Tree BPDU's received (and discarded) on the port.
- **Buttons**



Auto-refresh: Check this box to refresh the page automatically. Automatic refresh occurs every 3 seconds.

Clear: Clears the counters for the selected port.

Refresh: Click to refresh the page.

4-9 IPMC

4-9.1 IGMP Snooping

4-9.1.1 Status



After you complete the IGMP Snooping configuration, then you could to let the switch display the IGMP Snooping Status. The Section provides you to let switch to display the IGMP Snooping detail status.

Web Interface

To display the IGMP Snooping status in the web interface:

1. Click Monitor, IGMP Snooping, Status
2. If you want to auto-refresh the information then you need to evoke the “Auto-refresh”.
3. Click “Refresh” to refresh the IGMP Snooping Status.
4. Click “Clear” to clear the IGMP Snooping Status.

Figure 4-9.1.1: The IGMP Snooping Status.

IGMP Snooping Status									
Home > Monitor > IPMC > IGMP Snooping > Status									
Auto-refresh <input type="checkbox"/>  									
Statistics									
VLAN ID	Querier Version	Host Version	Querier Status	Queries Transmitted	Queries Received	V1 Reports Received	V2 Reports Received	V3 Reports Received	V2 Leaves Received
Router Port									
Port				Status					
1				-					
2				-					
3				-					
4				-					
23				-					
24				-					
25				-					
26				-					

Parameter description:

- **VLAN ID :**
The VLAN ID of the entry.
- **Querier Version :**
Working Querier Version currently.
- **Host Version :**
Working Host Version currently.
- **Querier Status :**

Shows the Querier status is "ACTIVE" or "IDLE".

"DISABLE" denotes the specific interface is administratively disabled.

- **Queries Transmitted :**

The number of Transmitted Queries.

- **Queries Received :**

The number of Received Queries.

- **V1 Reports Received :**

The number of Received V1 Reports.

- **V2 Reports Received :**

The number of Received V2 Reports.

- **V3 Reports Received :**

The number of Received V3 Reports.

- **V2 Leaves Received :**

The number of Received V2 Leaves.

- **Router Port**

Display which ports act as router ports. A router port is a port on the Ethernet switch that leads towards the Layer 3 multicast device or IGMP querier.

Static denotes the specific port is configured to be a router port.

Dynamic denotes the specific port is learnt to be a router port.

Both denote the specific port is configured or learnt to be a router port.

- **Port**

Switch port number.

- **Status**

Indicate whether specific port is a router port or not.

- **Buttons**



Auto-refresh: Check this box to refresh the page automatically. Automatic refresh occurs every 3 seconds.

Clear: Clears the counters for the selected port.

Refresh: Click to refresh the page.

4-9.1.2 Group Information

After you complete to set the IGMP Snooping function then you could let the switch to display the IGMP Snooping Group Information. Entries in the IGMP Group Table are shown on this page. The IGMP Group Table is sorted first by VLAN ID, and then by group. The will use the last entry of the currently displayed table as a basis for the next lookup. When the end is reached the text "No more entries" is shown in the displayed table. Use the button to start over.

Web Interface

To display the IGMP Snooping Group Information in the web interface:

1. Click Monitor, IGMP Snooping, Group Information
2. If you want to auto-refresh the information then you need to evoke the "Auto-refresh".
3. Click "Refresh" to refresh a entry of the IGMP Snooping Groups Information.
4. Click "<< or >> " to move to previous or next entry.

Figure 4-9.1.2: The IGMP Snooping Groups Information.

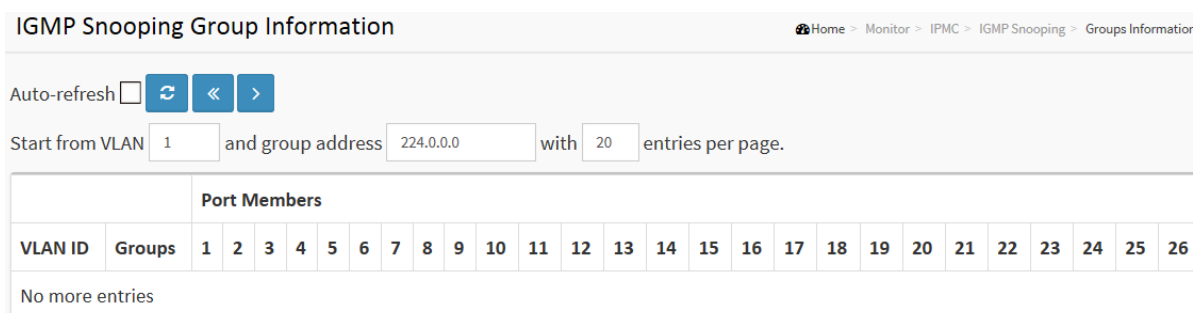

Parameter description:

Navigating the IGMP Group Table

Each page shows up to 99 entries from the IGMP Group table, default being 20, selected through the "entries per page" input field. When first visited, the web page will show the first 20 entries from the beginning of the IGMP Group Table.

The "Start from VLAN", and "group" input fields allow the user to select the starting point in the IGMP Group Table. Clicking the button will update the displayed table starting from that or the closest next IGMP Group Table match. In addition, the two input fields will - upon a button click - assume the value of the first displayed entry, allowing for continuous refresh with the same start address.

The will use the last entry of the currently displayed table as a basis for the next lookup. When the end is reached the text "No more entries" is shown in the displayed table. Use the button to start over.

IGMP Group Table Columns

- **VLAN ID :**
VLAN ID of the group.
- **Groups :**
Group address of the group displayed.
- **Port Members :**
Ports under this group.

- **Buttons**



Auto-refresh: Check this box to refresh the page automatically. Automatic refresh occurs every 3 seconds.

Refresh: Click to refresh the page.

|<<: Updates the system log entries to the first available entry ID

>> : Updates the system log entry to the next available entry ID

4-10 LLDP

4-10.1 Neighbour

This page provides a status overview for all LLDP neighbours. The displayed table contains a row for each port on which an LLDP neighbour is detected. The columns hold the following information:

Web Interface

To show LLDP neighbours:

1. Click Monitor, LLDP, Neighbours.
2. Click Refresh for manual update web screen
3. Click Auto-refresh for auto-update web screen

Figure 4-10.1: The LLDP Neighbours information



NOTE: If your network without any device supports LLDP then the table will show "No LLDP neighbour information found".

Parameter description:

- **Local Port :**
The port on which the LLDP frame was received.
- **Chassis ID :**
The Chassis ID is the identification of the neighbour's LLDP frames.
- **Port ID :**
The Remote Port ID is the identification of the neighbour port.
- **Port Description :**
Port Description is the port description advertised by the neighbour unit.
- **System Name :**
System Name is the name advertised by the neighbour unit.
- **System Capabilities :**
System Capabilities describes the neighbour unit's capabilities. The possible capabilities are:
 1. Other
 2. Repeater
 3. Bridge
 4. WLAN Access Point

5. Router
6. Telephone
7. DOCSIS cable device
8. Station only
9. Reserved

When a capability is enabled, the capability is followed by (+). If the capability is disabled, the capability is followed by (-).

- **Management Address :**

Management Address is the neighbour unit's address that is used for higher layer entities to assist discovery by the network management. This could for instance hold the neighbour's IP address.

- **Buttons**

Auto-refresh

Auto-refresh: Check this box to refresh the page automatically. Automatic refresh occurs every 3 seconds.

Refresh: Click to refresh the page.

4-10.2 LLDP-MED Neighbour

This page provides a status overview of all LLDP-MED neighbours. The displayed table contains a row for each port on which an LLDP neighbour is detected. This function applies to VoIP devices which support LLDP-MED. The columns hold the following information:

Web Interface

To show LLDP-MED neighbor:

1. Click Monitor, LLDP, LLDP-MED Neighbor.
2. Click Refresh for manual update web screen
3. Click Auto-refresh for auto-update web screen

Figure 4-10.2: The LLDP-MED Neighbours information

LLDP-MED Neighbor Information Home > Monitor > LLDP > LLDP-MED Neighbors

Auto-refresh 

Local Port
No LLDP-MED neighbor information found



NOTE: If your network without any device supports LLDP-MED then the table will show "No LLDP-MED neighbour information found".

Parameter description:

- **Port :**

The port on which the LLDP frame was received.

- **Device Type :**

LLDP-MED Devices are comprised of two primary Device Types: Network Connectivity Devices and Endpoint Devices.

- **LLDP-MED Network Connectivity Device Definition**

LLDP-MED Network Connectivity Devices, as defined in TIA-1057, provide access to the IEEE 802 based LAN infrastructure for LLDP-MED Endpoint Devices. An LLDP-MED Network Connectivity Device is a LAN access device based on any of the following technologies:

1. LAN Switch/Router
2. IEEE 802.1 Bridge
3. IEEE 802.3 Repeater (included for historical reasons)
4. IEEE 802.11 Wireless Access Point
5. Any device that supports the IEEE 802.1AB and MED extensions defined by TIA-1057 and can relay IEEE 802 frames via any method.

- **LLDP-MED Endpoint Device Definition :**

LLDP-MED Endpoint Devices, as defined in TIA-1057, are located at the IEEE 802 LAN network edge, and participate in IP communication service using the LLDP-MED framework.

Within the LLDP-MED Endpoint Device category, the LLDP-MED scheme is broken into further Endpoint Device Classes, as defined in the following.

Each LLDP-MED Endpoint Device Class is defined to build upon the capabilities defined for the previous Endpoint Device Class. For-example will any LLDP-MED Endpoint Device

claiming compliance as a Media Endpoint (Class II) also support all aspects of TIA-1057 applicable to Generic Endpoints (Class I), and any LLDP-MED Endpoint Device claiming compliance as a Communication Device (Class III) will also support all aspects of TIA-1057 applicable to both Media Endpoints (Class II) and Generic Endpoints (Class I).

■ **LLDP-MED Generic Endpoint (Class I) :**

The LLDP-MED Generic Endpoint (Class I) definition is applicable to all endpoint products that require the base LLDP discovery services defined in TIA-1057, however do not support IP media or act as an end-user communication appliance. Such devices may include (but are not limited to) IP Communication Controllers, other communication related servers, or any device requiring basic services as defined in TIA-1057.

Discovery services defined in this class include LAN configuration, device location, network policy, power management, and inventory management.

■ **LLDP-MED Media Endpoint (Class II) :**

The LLDP-MED Media Endpoint (Class II) definition is applicable to all endpoint products that have IP media capabilities however may or may not be associated with a particular end user. Capabilities include all of the capabilities defined for the previous Generic Endpoint Class (Class I), and are extended to include aspects related to media streaming. Example product categories expected to adhere to this class include (but are not limited to) Voice / Media Gateways, Conference Bridges, Media Servers, and similar.

Discovery services defined in this class include media-type-specific network layer policy discovery.

■ **LLDP-MED Communication Endpoint (Class III) :**

The LLDP-MED Communication Endpoint (Class III) definition is applicable to all endpoint products that act as end user communication appliances supporting IP media. Capabilities include all of the capabilities defined for the previous Generic Endpoint (Class I) and Media Endpoint (Class II) classes, and are extended to include aspects related to end user devices. Example product categories expected to adhere to this class include (but are not limited to) end user communication appliances, such as IP Phones, PC-based softphones, or other communication appliances that directly support the end user.

Discovery services defined in this class include provision of location identifier (including ECS / E911 information), embedded L2 switch support, inventory management.

● **LLDP-MED Capabilities :**

LLDP-MED Capabilities describes the neighborhood unit's LLDP-MED capabilities. The possible capabilities are:

1. LLDP-MED capabilities
2. Network Policy
3. Location Identification
4. Extended Power via MDI - PSE
5. Extended Power via MDI - PD
6. Inventory
7. Reserved

● **Application Type :**

Application Type indicating the primary function of the application(s) defined for this network policy, advertised by an Endpoint or Network Connectivity Device. The possible application types are shown below.

1. Voice - for use by dedicated IP Telephony handsets and other similar appliances supporting interactive voice services. These devices are typically deployed on a separate VLAN for ease of deployment and enhanced security by isolation from data applications.
2. Voice Signalling - for use in network topologies that require a different policy for the voice signalling than for the voice media.
3. Guest Voice - to support a separate limited feature-set voice service for guest users and

visitors with their own IP Telephony handsets and other similar appliances supporting interactive voice services.

4. Guest Voice Signalling - for use in network topologies that require a different policy for the guest voice signalling than for the guest voice media.

5. Softphone Voice - for use by softphone applications on typical data centric devices, such as PCs or laptops.

6. Video Conferencing - for use by dedicated Video Conferencing equipment and other similar appliances supporting real-time interactive video/audio services.

7. Streaming Video - for use by broadcast or multicast based video content distribution and other similar applications supporting streaming video services that require specific network policy treatment. Video applications relying on TCP with buffering would not be an intended use of this application type.

8. Video Signalling - for use in network topologies that require a separate policy for the video signalling than for the video media.

- **Policy :**

Policy indicates that an Endpoint Device wants to explicitly advertise that the policy is required by the device. Can be either Defined or Unknown

Unknown: The network policy for the specified application type is currently unknown.

Defined: The network policy is defined.

- **TAG :**

TAG is indicative of whether the specified application type is using a tagged or an untagged VLAN. Can be Tagged or Untagged.

Untagged: The device is using an untagged frame format and as such does not include a tag header as defined by IEEE 802.1Q-2003.

Tagged: The device is using the IEEE 802.1Q tagged frame format.

- **VLAN ID :**

VLAN ID is the VLAN identifier (VID) for the port as defined in IEEE 802.1Q-2003. A value of 1 through 4094 is used to define a valid VLAN ID. A value of 0 (Priority Tagged) is used if the device is using priority tagged frames as defined by IEEE 802.1Q-2003, meaning that only the IEEE 802.1D priority level is significant and the default PVID of the ingress port is used instead.

- **Priority :**

Priority is the Layer 2 priority to be used for the specified application type. One of the eight priority levels (0 through 7).

- **DSCP :**

DSCP is the DSCP value to be used to provide Diffserv node behavior for the specified application type as defined in IETF RFC 2474. Contain one of 64 code point values (0 through 63).

- **Auto-negotiation**

Auto-negotiation identifies if MAC/PHY auto-negotiation is supported by the link partner.

- **Auto-negotiation status**

Auto-negotiation status identifies if auto-negotiation is currently enabled at the link partner. If **Auto-negotiation** is supported and **Auto-negotiation status** is disabled, the 802.3 PMD operating mode will be determined the operational MAU type field value rather than by auto-negotiation.

- **Auto-negotiation Capabilities**

Auto-negotiation Capabilities shows the link partners MAC/PHY capabilities.

- **Buttons**

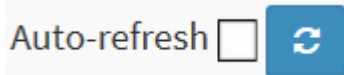

Auto-refresh: Check this box to refresh the page automatically. Automatic refresh occurs every 3 seconds.

Refresh: Click to refresh the page.

4-10.3 PoE

This page allows the user to inspect the current status for all PoE ports. The section show all port Power Over Ethernet Status.

Web Interface

To show LLDP EEE neighbors:

1. Click Monitor ,LLDP, PoE
2. Display Power Over Ethernet Status Information
3. Click Auto-refresh for auto-update web screen

Figure 4-10.3: The LLDP Neighbors EEE information



Local Port	Power Type	Power Source	Power Priority	Maximum Power
No PoE neighbor information found				

Parameter description:

- **Local Port :**

The port for this switch on which the LLDP frame was received.

- **Power Type :**

The Power Type represents whether the device is a Power Sourcing Entity (PSE) or Power Device (PD).

If the Power Type is unknown it is represented as "Reserved".

- **Power Source :**

The Power Source represents the power source being utilized by a PSE or PD device.

If the device is a PSE device it can either run on its Primary Power Source or its Backup Power Source. If it is unknown whether the PSE device is using its Primary Power Source or its Backup Power Source it is indicated as "Unknown"

If the device is a PD device it can either run on its local power supply or it can use the PSE as power source. It can also use both its local power supply and the PSE.

If it is unknown what power supply the PD device is using it is indicated as "Unknown"

- **Power Priority :**

Power Priority represents the priority of the PD device, or the power priority associated with the PSE type device's port that is sourcing the power. There are three levels of power priority. The three levels are: Critical, High and Low.

If the power priority is unknown it is indicated as "Unknown"

- **Maximum Power :**

The Maximum Power Value contains a numerical value that indicates the maximum power in watts required by a PD device from a PSE device, or the minimum power a PSE device is capable of sourcing over a maximum length cable based on its current configuration.

The maximum allowed value is 102.3 W. If the device indicates value higher than 102.3 W, it is represented as "reserved"

- **Buttons**

Auto-refresh

Auto-refresh: Check this box to refresh the page automatically. Automatic refresh occurs every 3 seconds.

Refresh: Click to refresh the page.

4-10.4EEE

By using EEE power savings can be achieved at the expense of traffic latency. This latency occurs due to that the circuits EEE turn off to save power, need time to boot up before sending traffic over the link. This time is called "wakeup time". To achieve minimal latency, devices can use LLDP to exchange information about their respective tx and rx "wakeup time", as a way to agree upon the minimum wakeup time they need.

This page provides an overview of EEE information exchanged by LLDP.

Web Interface

To show LLDP EEE neighbors:

1. Click Monitor ,LLDP, then click EEE to show discover EEE devices
2. Click Refresh for manual update web screen
3. Click Auto-refresh for auto-update web screen

Figure 4-10.4: The LLDP Neighbors EEE information

LLDP Neighbors EEE Information Home > Monitor > LLDP > EEE

Auto-refresh 

Local Port	Tx Tw	Rx Tw	Fallback Receive Tw	Echo Tx Tw	Echo Rx Tw	Resolved Tx Tw	Resolved Rx Tw	EEE in Sync
No LLDP EEE information found								



NOTE: If your network without any devices which enables EEE function then the table will show "No LLDP EEE information found".

Parameter description:

- **Local Port :**

The port on which LLDP frames are received or transmitted.

- **Tx Tw :**

The link partner's maximum time that transmit path can hold off sending data after reassertion of LPI.

- **Rx Tw :**

The link partner's time that receiver would like the transmitter to hold off to allow time for the receiver to wake from sleep.

- **Fallback Receive Tw :**

The link partner's fallback receive Tw.

A receiving link partner may inform the transmitter of an alternate desired Tw_sys_tx. Since a receiving link partner is likely to have discrete levels for savings, this provides the transmitter with additional information that it may use for a more efficient allocation. Systems that do not implement this option default the value to be the same as that of the Receive Tw_sys_tx.

- **Echo Tx Tw :**

The link partner's Echo Tx Tw value.

The respective echo values shall be defined as the local link partners reflection (echo) of the remote link partners respective values. When a local link partner receives its echoed values from the remote link partner it can determine whether or not the remote link partner has received, registered and processed its most recent values. For example, if the local link partner receives echoed parameters that do not match the values in its local MIB, then the

local link partner infers that the remote link partners request was based on stale information.

- **Echo Rx Tw :**

The link partner's Echo Rx Tw value.

- **Resolved Tx Tw :**

The resolved Tx Tw for this link. Note: NOT the link partner

The resolved value that is the actual "tx wakeup time " used for this link (based on EEE information exchanged via LLDP).

- **Resolved Rx Tw :**

The resolved Rx Tw for this link. Note : NOT the link partner

The resolved value that is the actual "tx wakeup time" used for this link (based on EEE information exchanged via LLDP).

- **EEE in Sync**

Shows whether the switch and the link partner have agreed on wake times.

Red - Switch and link partner have not agreed on wakeup times.

Green - Switch and link partner have agreed on wakeup times.

- **Buttons**

Auto-refresh

Auto-refresh: Check this box to refresh the page automatically. Automatic refresh occurs every 3 seconds.

Refresh: Click to refresh the page.

4-10.5 Port Statistics

Two types of counters are shown. Global counters are counters that refer to the whole switch, while local counters refer to per port counters for the currently selected switch



Web Interface

To show LLDP Statistics:

1. Click Monitor ,LLDP, then click Port Statistics to show LLDP counters
2. Click Refresh for manual update web screen
3. Click Auto-refresh for auto-update web screen
4. Click Clear to clear all counters

Figure 4-10.5: The LLDP Port Statistics information

LLDP Counters Home > Monitor > LLDP > Port Statistics

Auto-refresh  

LLDP Global Counters	
Neighbor entries were last changed	2011-01-01T00:00:00+00:00 (28408 secs. ago)
Total Neighbors Entries Added	0
Total Neighbors Entries Deleted	0
Total Neighbors Entries Dropped	0
Total Neighbors Entries Aged Out	0

LLDP Statistics Local Counters								
Local Port	Tx Frames	Rx Frames	Rx Errors	Frames Discarded	TLVs Discarded	TLVs Unrecognized	Org. Discarded	Age-Outs
1	917	0	0	0	0	0	0	0
2	0	0	0	0	0	0	0	0
3	0	0	0	0	0	0	0	0
4	0	0	0	0	0	0	0	0
5	0	0	0	0	0	0	0	0
24	0	0	0	0	0	0	0	0
25	0	0	0	0	0	0	0	0
26	0	0	0	0	0	0	0	0

Parameter description:

Global Counters

- **Neighbour entries were last changed at :**

It also shows the time when the last entry was last deleted or added. It also shows the time elapsed since the last change was detected.

- **Total Neighbours Entries Added :**

Shows the number of new entries added since switch reboot.

- **Total Neighbours Entries Deleted :**

Shows the number of new entries deleted since switch reboot.

- **Total Neighbours Entries Dropped :**

Shows the number of LLDP frames dropped due to the entry table being full.

- **Total Neighbours Entries Aged Out :**

Shows the number of entries deleted due to Time-To-Live expiring.

Local Counters

The displayed table contains a row for each port. The columns hold the following information:

- **Local Port :**

The port on which LLDP frames are received or transmitted.

- **Tx Frames :**

The number of LLDP frames transmitted on the port.

- **Rx Frames :**

The number of LLDP frames received on the port.

- **Rx Errors :**

The number of received LLDP frames containing some kind of error.

- **Frames Discarded :**

If an LLDP frame is received on a port, and the switch's internal table has run full, the LLDP frame is counted and discarded. This situation is known as "Too Many Neighbours" in the LLDP standard. LLDP frames require a new entry in the table when the Chassis ID or Remote Port ID is not already contained within the table. Entries are removed from the table when a given port's link is down, an LLDP shutdown frame is received, or when the entry ages out.

- **TLVs Discarded :**

Each LLDP frame can contain multiple pieces of information, known as TLVs (TLV is short for "Type Length Value"). If a TLV is malformed, it is counted and discarded.

- **TLVs Unrecognized :**

The number of well-formed TLVs, but with an unknown type value.

- **Org. Discarded :**

The number of organizationally received TLVs.

- **Age-Outs :**

Each LLDP frame contains information about how long time the LLDP information is valid (age-out time). If no new LLDP frame is received within the age out time, the LLDP information is removed, and the Age-Out counter is incremented.

- **Buttons**



Auto-refresh: Check this box to refresh the page automatically. Automatic refresh occurs every 3 seconds.

Clear: Clears the counters for the selected port.

Refresh: Click to refresh the page.

4-11 PoE

This page allows the user to inspect the current status for all PoE ports.

Web Interface

To Display ECE Statistics in the web interface:

1. Click Monitor, PoE
2. Checked "Auto-refresh".
3. Click "Refresh" to refresh the port detailed statistics.

Figure 4-11.2: The PoE Statistics

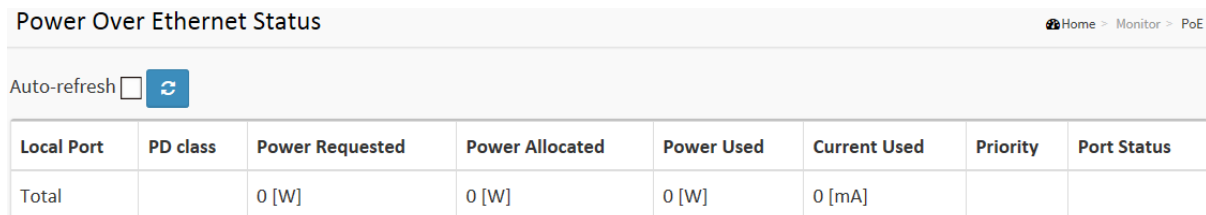

Local Port	PD class	Power Requested	Power Allocated	Power Used	Current Used	Priority	Port Status
Total		0 [W]	0 [W]	0 [W]	0 [mA]		

Parameter description:

- **Local Port**

This is the logical port number for this row.

- **PD Class**

Each PD is classified according to a class that defines the maximum power the PD will use. The PD Class shows the PDs class.

Five Classes are defined:

Class 0: Max. power 15.4 W

Class 1: Max. power 4.0 W

Class 2: Max. power 7.0 W

Class 3: Max. power 15.4 W

Class 4: Max. power 30.0 W

- **Power Requested**

The Power Requested shows the requested amount of power the PD wants to be reserved.

- **Power Allocated**

The Power Allocated shows the amount of power the switch has allocated for the PD.

- **Power Used**

The Power Used shows how much power the PD currently is using.

- **Current Used**

The Power Used shows how much current the PD currently is using.

- **Priority**

The Priority shows the port's priority configured by the user.

- **Port Status**

The Port Status shows the port's status. The status can be one of the following values:

PoE not available - No PoE chip found - PoE not supported for the port.

PoE turned OFF - PoE disabled : PoE is disabled by user.

PoE turned OFF - Power budget exceeded - The total requested or used power by the PDs exceeds the maximum power the Power Supply can deliver, and port(s) with the lowest priority is/are powered down.

No PD detected - No PD detected for the port.

PoE turned OFF - PD overload - The PD has requested or used more power than the port can deliver, and is powered down.

PoE turned OFF - PD is off.

Invalid PD - PD detected, but is not working correctly.

- **Buttons**

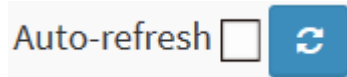

Auto-refresh: Check this box to refresh the page automatically. Automatic refresh occurs every 3 seconds.

Refresh: Click to refresh the page.

4-12 MAC Table

Entries in the MAC Table are shown on this page. The MAC Table contains up to 8192 entries, and is sorted first by VLAN ID, then by MAC address.

Web Interface

To Display MAC Address Table in the web interface:

1. Click Monitor, Dynamic MAC Table.
2. Specify the VLAN and MAC Address.
3. Display MAC Address Table.

Figure 4- 12: The MAC Address Table

MAC Address Table Home > Monitor > MAC Table

Auto-refresh ↺ ↻ ↷

Start from VLAN and MAC address with entries per page.

Type	VLAN	MAC Address	CPU	Port Members																									
				1	2	3	4	5	6	7	8	9	10	11	12	13	14	15	16	17	18	19	20	21	22	23	24	25	26
Static	1	00-40-C7-01-02-03	✓																										
Static	1	33-33-00-00-00-01	✓	✓	✓	✓	✓	✓	✓	✓	✓	✓	✓	✓	✓	✓	✓	✓	✓	✓	✓	✓	✓	✓	✓	✓	✓	✓	✓
Static	1	33-33-00-00-00-02	✓	✓	✓	✓	✓	✓	✓	✓	✓	✓	✓	✓	✓	✓	✓	✓	✓	✓	✓	✓	✓	✓	✓	✓	✓	✓	✓
Static	1	33-33-FF-01-02-03	✓	✓	✓	✓	✓	✓	✓	✓	✓	✓	✓	✓	✓	✓	✓	✓	✓	✓	✓	✓	✓	✓	✓	✓	✓	✓	✓
Dynamic	1	3C-97-0E-16-EB-7E		✓																									
Static	1	FF-FF-FF-FF-FF-FF	✓	✓	✓	✓	✓	✓	✓	✓	✓	✓	✓	✓	✓	✓	✓	✓	✓	✓	✓	✓	✓	✓	✓	✓	✓	✓	✓

Parameter description:

Navigating the MAC Table

Each page shows up to 999 entries from the MAC table, default being 20, selected through the "entries per page" input field. When first visited, the web page will show the first 20 entries from the beginning of the MAC Table. The first displayed will be the one with the lowest VLAN ID and the lowest MAC address found in the MAC Table.

The "Start from MAC address" and "VLAN" input fields allow the user to select the starting point in the MAC Table. Clicking the "Refresh" button will update the displayed table starting from that or the closest next MAC Table match. In addition, the two input fields will - upon a "Refresh" button click - assume the value of the first displayed entry, allowing for continuous refresh with the same start address.

The >> will use the last entry of the currently displayed VLAN/MAC address pairs as a basis for the next lookup. When the end is reached the text "No more entries" is shown in the displayed table. Use the << button to start over.

MAC Table Columns

- **Switch (stack only)**

The stack unit where the entry is learned.

- **Type :**

Indicates whether the entry is a static or a dynamic entry.

- **VLAN :**

The VLAN ID of the entry.

- **MAC address :**
The MAC address of the entry.
- **Port Members :**
The ports that are members of the entry.
- **Buttons**



Auto-refresh: Check this box to refresh the page automatically. Automatic refresh occurs every 3 seconds.

Clear: Clears the counters for the selected port.

Refresh: Click to refresh the page.

|<<: Updates the system log entries to the first available entry ID

>> : Updates the system log entry to the next available entry ID



NOTE:

00-02-D1-73-01-29 : your switch MAC address (for IPv4)
 33-33-00-00-00-01 : Destination MAC (for IPv6 Router Advertisement) (reference IPv6 RA.JPG)
 33-33-00-00-00-02 : Destination MAC (for IPv6 Router Solicitation) (reference IPv6 RS.JPG)
 33-33-FF-73-01-29 : Destination MAC (for IPv6 Neighbor Solicitation) (reference IPv6 DAD.JPG)
 33-33-FF-A8-01-01: your switch MAC address (for IPv6 global IP)
 FF-FF-FF-FF-FF-FF: for Broadcast.

4-13 VLANs

4-13.1 VLAN Membership

This page provides an overview of membership status of VLAN users.

The ports belong to the currently selected stack unit, as reflected by the page header.

Web Interface

To configure VLAN membership configuration in the web interface:

1. Click Monitor, VLANs, VLAN membership.
2. Scroll the bar to choice which VLANs would like to show up.
3. Click Refresh to update the state.

Figure 4-13.1: VLAN Membership Status for Combined users

VLAN Membership Status for Combined users Home > Monitor > VLANs > Membership

Auto-refresh ↻ ⏪ ⏩ Combined ⌵

Start from VLAN with entries per page.

VLAN ID	Port Members																										
	1	2	3	4	5	6	7	8	9	10	11	12	13	14	15	16	17	18	19	20	21	22	23	24	25	26	
1	✓	✓	✓	✓	✓	✓	✓	✓	✓	✓	✓	✓	✓	✓	✓	✓	✓	✓	✓	✓	✓	✓	✓	✓	✓	✓	✓

Parameter description:

- **VLAN USER**

VLAN User module uses services of the VLAN management functionality to configure VLAN memberships and VLAN port configurations such as PVID and UVID. Currently we support the following VLAN user types:

CLI/Web/SNMP : These are referred to as static.

NAS : NAS provides port-based authentication, which involves communications between a Supplicant, Authenticator, and an Authentication Server.

MVRP : Multiple VLAN Registration Protocol (MVRP) allows dynamic registration and deregistration of VLANs on ports on a VLAN bridged network.

Voice VLAN : Voice VLAN is a VLAN configured specially for voice traffic typically originating from IP phones.

MVR : MVR is used to eliminate the need to duplicate multicast traffic for subscribers in each VLAN. Multicast traffic for all channels is sent only on a single (multicast) VLAN.

MSTP : The 802.1s Multiple Spanning Tree protocol (MSTP) uses VLANs to create multiple spanning trees in a network, which significantly improves network resource utilization while maintaining a loop-free environment.

- **VLAN ID**

VLAN ID for which the Port members are displayed.

- **Port Members**

A row of check boxes for each port is displayed for each VLAN ID.

If a port is included in a VLAN, an image  will be displayed.

If a port is included in a Forbidden port list, an image  will be displayed.

If a port is included in a Forbidden port list and dynamic VLAN user register VLAN on same Forbidden port, then conflict port will be displayed as .

- **VLAN Membership**

The VLAN Membership Status Page shall show the current VLAN port members for all VLANs configured by a selected VLAN User (selection shall be allowed by a Combo Box). When ALL VLAN Users are selected, it shall show this information for all the VLAN Users, and this is by default. VLAN membership allows the frames classified to the VLAN ID to be forwarded on the respective VLAN member ports.

Navigating the VLAN Monitor page

Each page shows up to 99 entries from the VLAN table, default being 20, selected through the "entries per page" input field. When first visited, the web page will show the first 20 entries from the beginning of the VLAN Table. The first displayed will be the one with the lowest VLAN ID found in the VLAN Table.

The "VLAN" input fields allow the user to select the starting point in the VLAN Table. Clicking the "**Refresh**" button will update the displayed table starting from that or the closest next VLAN Table match. The ">>" will use the last entry of the currently displayed VLAN entry as a basis for the next lookup. When the end is reached the text "No more entries" is shown in the displayed table. Use the "<<" button to start over.

- **Buttons**



Auto-refresh: Check this box to refresh the page automatically. Automatic refresh occurs every 3 seconds.

Refresh: Click to refresh the page.

4-13.2 VLAN Port

The function Port Status gathers the information of all VLAN status and reports it by the order of Static NAS MVRP MVP Voice VLAN MSTP GVRP Combined.

Web Interface

To Display VLAN Port Status in the web interface:

1. Click Monitor, VLAN Port Status.
2. Specify the Static NAS MVRP MVP Voice VLAN MSTP GVRP Combined.
3. Display Port Status information.

Figure 4-13.2: The VLAN Port Status for Static user

VLAN Port Status for Combined users Home > Monitor > VLANs > Ports

Auto-refresh  Combined

Port	Port Type	Ingress Filtering	Frame Type	Port VLAN ID	Tx Tag	Untagged VLAN ID	Conflicts
1	C-Port	<input checked="" type="checkbox"/>	All	1	Untag PVID		No
2	C-Port	<input checked="" type="checkbox"/>	All	1	Untag PVID		No
3	C-Port	<input checked="" type="checkbox"/>	All	1	Untag PVID		No
4	C-Port	<input checked="" type="checkbox"/>	All	1	Untag PVID		No
5	C-Port	<input checked="" type="checkbox"/>	All	1	Untag PVID		No
6	C-Port	<input checked="" type="checkbox"/>	All	1	Untag PVID		No
7	C-Port	<input checked="" type="checkbox"/>	All	1	Untag PVID		No

Parameter description:

VLAN USER

VLAN User module uses services of the VLAN management functionality to configure VLAN memberships and VLAN port configuration such as PVID, UVID. Currently we support following VLAN User types:

CLI/Web/SNMP : These are referred to as static.

NAS : NAS provides port-based authentication, which involves communications between a Supplicant, Authenticator, and an Authentication Server.

Voice VLAN: Voice VLAN is a VLAN configured specially for voice traffic typically originating from IP phones.

MVR: MVR is used to eliminate the need to duplicate multicast traffic for subscribers in each VLAN. Multicast traffic for all channels is sent only on a single (multicast) VLAN.

MSTP: The 802.1s Multiple Spanning Tree protocol (MSTP) uses VLANs to create multiple spanning trees in a network, which significantly improves network resource utilization while maintaining a loop-free environment.

- **Port** :

The logical port for the settings contained in the same row.

- **Port Type** :

Shows the Port Type. Port type can be any of Unaware, C-port, S-port, Custom S-port.

If Port Type is Unaware, all frames are classified to the Port VLAN ID and tags are not removed. C-port is Customer Port. S-port is Service port. Custom S-port is S-port with Custom TPID.

- **Ingress Filtering :**

Shows the ingress filtering on a port. This parameter affects VLAN ingress processing. If ingress filtering is enabled and the ingress port is not a member of the classified VLAN, the frame is discarded.

- **Frame Type :**

Shows whether the port accepts all frames or only tagged frames. This parameter affects VLAN ingress processing. If the port only accepts tagged frames, untagged frames received on that port are discarded.

- **Port VLAN ID :**

Shows the Port VLAN ID (PVID) that a given user wants the port to have.

The field is empty if not overridden by the selected user.

- **Tx Tag :**

Shows egress filtering frame status whether tagged or untagged.

- **UVID :**

Shows UVID (untagged VLAN ID). Port's UVID determines the packet's behaviour at the egress side.

- **Conflicts :**

Shows status of Conflicts whether exists or not. When a Volatile VLAN User requests to set VLAN membership or VLAN port configuration, the following conflicts can occur:

Functional Conflicts between features.

Conflicts due to hardware limitation.

Direct conflict between user modules.

- **Buttons**



Auto-refresh: Check this box to refresh the page automatically. Automatic refresh occurs every 3 seconds.

Refresh: Click to refresh the page.

4-14 VCL

4-14.1 MAC-based VLAN

This section shows MAC-based VLAN entries configured by various MAC-based VLAN users. Currently we support following VLAN User types:

CLI/Web/SNMP : These are referred to as static.

NAS : NAS provides port-based authentication, which involves communications between a Supplicant, Authenticator, and an Authentication Server.

Web Interface

To Display MAC-based VLAN configuration in the web interface:

1. Click Monitor, MAC-based VLAN Status.
2. Specify the Static, NAS, Combined.
3. Display MAC-based information.

Figure 4-14.1: The MAC-based VLAN Membership Status for User Static

MAC-based VLAN Membership Status for User Static Home > Monitor > VCL > MAC-based VLAN

Auto-refresh  Static

MAC Address	VLAN ID	Port Members																									
		1	2	3	4	5	6	7	8	9	10	11	12	13	14	15	16	17	18	19	20	21	22	23	24	25	26
No data exists for the user																											

Parameter description:

- **MAC Address :**
Indicates the MAC address.
- **VLAN ID :**
Indicates the VLAN ID.
- **Port Members :**
Port members of the MAC-based VLAN entry.
- **Buttons**



Auto-refresh: Check this box to refresh the page automatically. Automatic refresh occurs every 3 seconds.

Refresh: Click to refresh the page.

4-14.2 Protocol-based VLAN

4-14.2.1 Protocol to Group

This page shows you the protocols to Group Name (unique for each Group) mapping entries for the switch.

Web Interface

To Display Protocol-based VLAN configuration in the web interface:

1. Click Monitor, VCL, Protocol to Group.
2. Checked "Auto-refresh".
3. Click "Refresh" to refresh the port detailed statistics.

Figure 4-14.1: The MAC-based VLAN Membership Status for User Static

Protocol to Group Mapping Table Status Home > Monitor > VCL > Protocol-based VLAN > Protocol to Group

Auto-refresh 

Frame Type	Value	Group Name
	No Group entry found!	

Parameter description:

- **Frame Type :**

Frame Type can have one of the following values:

1. Ethernet
2. LLC
3. SNAP



NOTE:

On changing the Frame type field, valid value of the following text field will vary depending on the new frame type you selected.

- **Value :**

Valid value that can be entered in this text field depends on the option selected from the preceding Frame Type selection menu.

Below is the criteria for three different Frame Types:

1. For Ethernet: Values in the text field when Ethernet is selected as a Frame Type is called etype. Valid values for etype ranges from 0x0600-0xffff
2. For LLC: Valid value in this case is comprised of two different sub-values.
 - a. DSAP: 1-byte long string (0x00-0xff)
 - b. SSAP: 1-byte long string (0x00-0xff)
3. For SNAP: Valid value in this case also is comprised of two different sub-values.
 - a. OUI: OUI (Organizationally Unique Identifier) is value in format of xx-xx-xx where each pair (xx) in string is a hexadecimal value ranges from 0x00-0xff.
 - b. PID: If the OUI is hexadecimal 000000, the protocol ID is the Ethernet type (EtherType) field value for the protocol running on top of SNAP; if the OUI is an OUI for a particular organization, the protocol ID is a value assigned by that organization to the protocol running

on top of SNAP.

In other words, if value of OUI field is 00-00-00 then value of PID will be etype (0x0600-0xffff) and if value of OUI is other than 00-00-00 then valid value of PID will be any value from 0x0000 to 0xffff.

- **Group Name :**

A valid Group Name is a unique 16-character long string for every entry which consists of a combination of alphabets (a-z or A-Z) and integers(0-9).



NOTE:

special character and underscore(_) are not allowed.

- **Buttons**

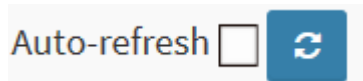

Auto-refresh: Check this box to refresh the page automatically. Automatic refresh occurs every 3 seconds.

Refresh: Click to refresh the page.

4-14.2.2 Group to VLAN

This page shows you the configured Group Name to a VLAN for the switch .

Web Interface

To Display Group to VLAN configuration in the web interface:

1. Click Monitor, VCL, Group to VLAN.
2. Checked "Auto-refresh".
3. Click "Refresh" to refresh the port detailed statistics.

Figure 4-14.2: The MAC-based VLAN Membership Status for User Static

Group Name to VLAN mapping Table Status Home > Monitor > VCL > Protocol-based VLAN > Group to VLAN

Auto-refresh 

Group Name	VLAN ID	Port Members																									
		1	2	3	4	5	6	7	8	9	10	11	12	13	14	15	16	17	18	19	20	21	22	23	24	25	26
No Group entries																											

Parameter description:

- **Group Name :**

A valid Group Name is a string at the most 16 characters which consists of a combination of alphabets (a-z or A-Z) and integers(0-9), no special character is allowed. whichever Group name you try map to a VLAN must be present in Protocol to Group mapping table and must not be pre-used by any other existing mapping entry on this page.

- **VLAN ID :**

Indicates the ID to which Group Name will be mapped. A valid VLAN ID ranges from 1-4095.

- **Port Members :**

A row of check boxes for each port is displayed for each Group Name to VLAN ID mapping. To include a port in a mapping, check the box. To remove or exclude the port from the mapping, make sure the box is unchecked. By default, no ports are members, and all boxes are unchecked.

- **Buttons**

Auto-refresh 

Auto-refresh: Check this box to refresh the page automatically. Automatic refresh occurs every 3 seconds.

Refresh: Click to refresh the page.

4-14.3 IP Subnet-based VLAN

The page shows IP subnet-based VLAN entries. This page shows only static entries.

Web Interface

To Display MAC-based VLAN configuration in the web interface:

1. Click Monitor, VCL, IP Subnet-based VLAN.
2. Checked "Auto-refresh".
3. Click "Refresh" to refresh the port detailed statistics.

Figure 4-18.3: The MAC-based VLAN Membership Status for User Static

IP Subnet-based VLAN Membership Status Home > Monitor > VCL > IP Subnet-based VLAN

Auto-refresh 

VCE ID	IP Address	Mask Length	VLAN ID	Port Members																									
				1	2	3	4	5	6	7	8	9	10	11	12	13	14	15	16	17	18	19	20	21	22	23	24	25	26
Currently no entries present																													

Parameter description:

- **VCE ID :**
Indicates the index of the entry. It is user configurable. Its value ranges from 0-128. If a VCE ID is 0, application will auto-generate the VCE ID for that entry. Deletion and lookup of IP subnet-based VLAN are based on VCE ID.
- **IP Address :**
Indicates the IP address.
- **Mask Length :**
Indicates the network mask length.
- **VLAN ID :**
Indicates the VLAN ID. VLAN ID can be changed for the existing entries.
- **Port Members :**
A row of check boxes for each port is displayed for each IP subnet-based VLAN entry. To include a port in a IP subnet-based VLAN, check the box. To remove or exclude the port from the IP subnet-based VLAN, make sure the box is unchecked. By default, no ports are members, and all boxes are unchecked.
- **Buttons**



Auto-refresh: Check this box to refresh the page automatically. Automatic refresh occurs every 3 seconds.

Refresh: Click to refresh the page.

Chapter 5. Switch- Diagnostics

This chapter provides a set of basic system diagnosis. It let users know that whether the system is health or needs to be fixed. The basic system check includes ICMP Ping, Link OAM, ICMPv6, and VeriPHY Cable Diagnostics.

5-1 Ping

This section allows you to issue ICMP PING packets to troubleshoot IPv6 connectivity issues.

Web Interface

To configure an ICMP PING Configuration in the web interface:

1. Specify ICMP PING IP Address.
2. Specify ICMP PING Size.
3. Click Start.

Figure 5-1: The ICMP Ping

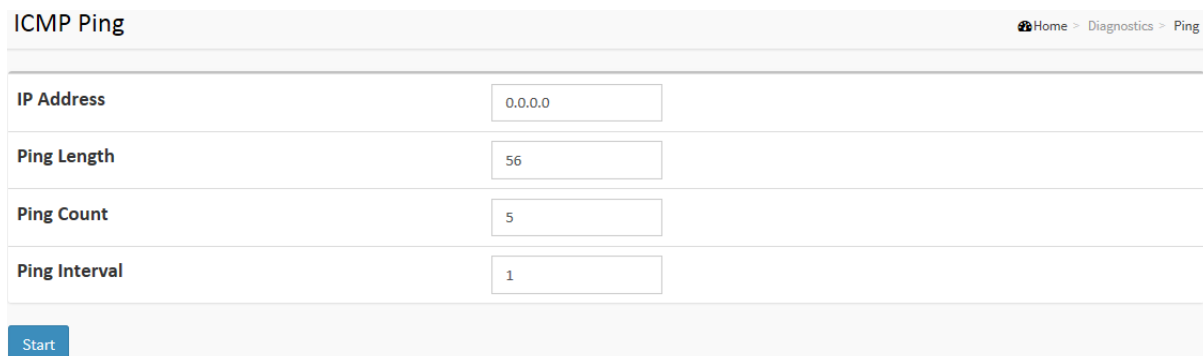

ICMP Ping	
IP Address	<input type="text" value="0.0.0.0"/>
Ping Length	<input type="text" value="56"/>
Ping Count	<input type="text" value="5"/>
Ping Interval	<input type="text" value="1"/>

[Start](#)

Parameter description:

- **IP Address :**
To set the IP Address of device what you want to ping it.
- **Ping Length:**
The payload size of the ICMP packet. Values range from 2 bytes to 1452 bytes.
- **Ping Count:**
The count of the ICMP packet. Values range from 1 time to 60 times.
- **Ping Interval:**
The interval of the ICMP packet. Values range from 0 second to 30 seconds.
- **Egress Interface (Only for IPv6):**

The VLAN ID (VID) of the specific egress IPv6 interface which ICMP packet goes.

The given VID ranges from 1 to 4094 and will be effective only when the corresponding IPv6 interface is valid.

When the egress interface is not given, PING6 finds the best match interface for destination.

Do not specify egress interface for loopback address.

Do specify egress interface for link-local or multicast address.

- **Start:**

Click the “Start” button then the switch will start to ping the device using ICMP packet size what set on the switch.

After you press, 5 ICMP packets are transmitted, and the sequence number and roundtrip time are displayed upon reception of a reply. The page refreshes automatically until responses to all packets are received, or until a timeout occurs.

```
PING6 server ::10.10.132.20
```

```
64 bytes from ::10.10.132.20: icmp_seq=0, time=0ms
```

```
64 bytes from ::10.10.132.20: icmp_seq=1, time=0ms
```

```
64 bytes from ::10.10.132.20: icmp_seq=2, time=0ms
```

```
64 bytes from ::10.10.132.20: icmp_seq=3, time=0ms
```

```
64 bytes from ::10.10.132.20: icmp_seq=4, time=0ms
```

```
Sent 5 packets, received 5 OK, 0 bad
```

5-2 Ping6

This section allows you to issue ICMPv6 PING packets to troubleshoot IPv6 connectivity issues.

Web Interface

To configure an ICMPv6 PING Configuration in the web interface:

1. Specify ICMPv6 PING IP Address.
2. Specify ICMPv6 PING Size.
3. Click Start.

Figure 5-2: The ICMPv6 Ping

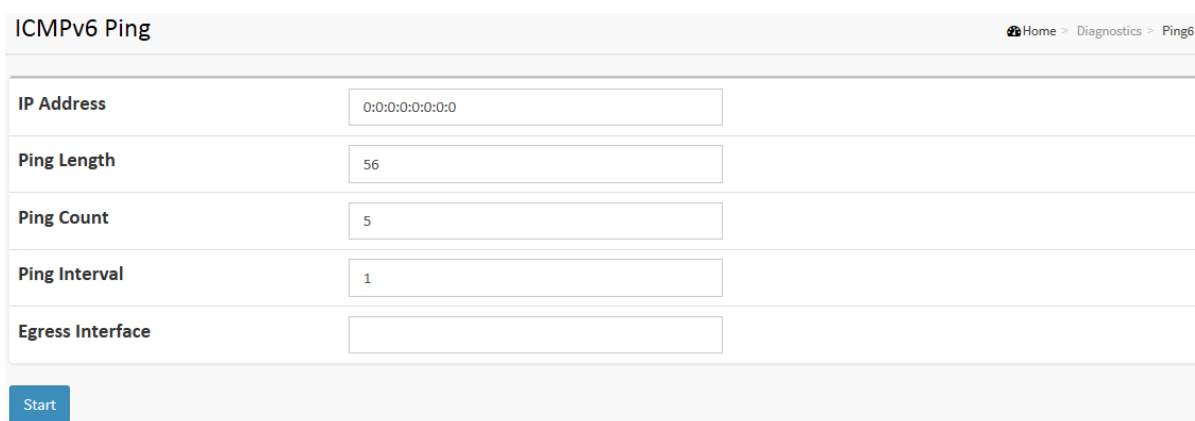

ICMPv6 Ping	
IP Address	0:0:0:0:0:0:0:0
Ping Length	56
Ping Count	5
Ping Interval	1
Egress Interface	

Start

Parameter description:

- **IP Address :**
The destination IP Address with IPv6
- **Ping Length :**
The payload size of the ICMP packet. Values range from 2 bytes to 1452 bytes.
- **Ping Count :**
The count of the ICMP packet. Values range from 1 time to 60 times.
- **Ping Interval :**
The interval of the ICMP packet. Values range from 0 second to 30 seconds.
- **Egress Interface (Only for IPv6) :**
The VLAN ID (VID) of the specific egress IPv6 interface which ICMP packet goes.
The given VID ranges from 1 to 4094 and will be effective only when the corresponding IPv6 interface is valid.
When the egress interface is not given, PING6 finds the best match interface for destination.
Do not specify egress interface for loopback address.
Do specify egress interface for link-local or multicast address.
- **Start:**
Click the “Start” button then the switch will start to ping the device using ICMPv6 packet size what set on the switch.

After you press , 5 ICMPv6 packets are transmitted, and the sequence number and roundtrip time are displayed upon reception of a reply. The page refreshes automatically until responses to all packets are received, or until a timeout occurs.

PING server 10.10.132.20

64 bytes from 10.10.132.20: icmp_seq=0, time=0ms

64 bytes from 10.10.132.20: icmp_seq=1, time=0ms

64 bytes from 10.10.132.20: icmp_seq=2, time=0ms

64 bytes from 10.10.132.20: icmp_seq=3, time=0ms

64 bytes from 10.10.132.20: icmp_seq=4, time=0ms

Sent 5 packets, received 5 OK, 0 bad

You can configure the following properties of the issued ICMP packets:

5-3 VeriPHY

This section is used for running the VeriPHY Cable Diagnostics. Press to run the diagnostics. This will take approximately 5 seconds. If all ports are selected, this can take approximately 15 seconds. When completed, the page refreshes automatically, and you can view the cable diagnostics results in the cable status table. Note that VeriPHY is only accurate for cables of length 7 -140 meters. 10 and 100 Mbps ports will be linked down while running VeriPHY. Therefore, running VeriPHY on a 10 or 100 Mbps management port will cause the switch to stop responding until VeriPHY is complete.

Web Interface

To configure a VeriPHY Cable Diagnostics Configuration in the web interface:

1. Specify Port which want to check.
2. Click Start.

Figure 5-3: The VeriPHY

VeriPHY Cable Diagnostics Home > Diagnostics > VeriPHY

Port:

Cable Status								
Port	Pair A	Length A	Pair B	Length B	Pair C	Length C	Pair D	Length D
1	--	--	--	--	--	--	--	--
2	--	--	--	--	--	--	--	--
3	--	--	--	--	--	--	--	--
4	--	--	--	--	--	--	--	--
5	--	--	--	--	--	--	--	--

Parameter description:

- **Port :**
The port where you are requesting VeriPHY Cable Diagnostics.
- **Cable Status :**
Port: Port number.
Pair: The status of the cable pair.
Length: The length (in meters) of the cable pair.

Below is the example of using the VeriPHY function:

VeriPHY Cable Diagnostics

Home -> Diagnostics -> VeriPHY

Port: All Start

Cable Status								
Port	Pair A	Length A	Pair B	Length B	Pair C	Length C	Pair D	Length D
1	OK	102	OK	102	--	102	--	102
2	OK	105	OK	105	--	102	--	102
3	OK	51	OK	51	--	48	--	51
4	OK	102	OK	102	--	102	--	102
5	Open	0	Open	0	Open	0	Open	0
6	Open	0	Open	0	Open	0	Open	0
7	Open	0	Open	0	Open	0	Open	0
8	Open	0	Open	0	Open	0	Open	0
9	OK	0	OK	0	OK	0	OK	0

OK - Correctly terminated pair

Open - Open pair

Short - Shorted pair

Short A - Cross-pair short to pair A

Short B - Cross-pair short to pair B

Short C - Cross-pair short to pair C

Short D - Cross-pair short to pair D

Cross A - Abnormal cross-pair coupling with pair A

Cross B - Abnormal cross-pair coupling with pair B

Cross C - Abnormal cross-pair coupling with pair C

Cross D - Abnormal cross-pair coupling with pair D

Length:

The length (in meters) of the cable pair. The resolution is 3 meters

5-4 Traceroute

This page allows you to issue ICMP, TCP, or UDP packets to diagnose network connectivity issues.

Web Interface

To configure an ICMPv6 PING Configuration in the web interface:

1. Specify traceroute IP Address.
2. Specify traceroute Size.
3. Click Start.

Figure 5-4: The Traceroute

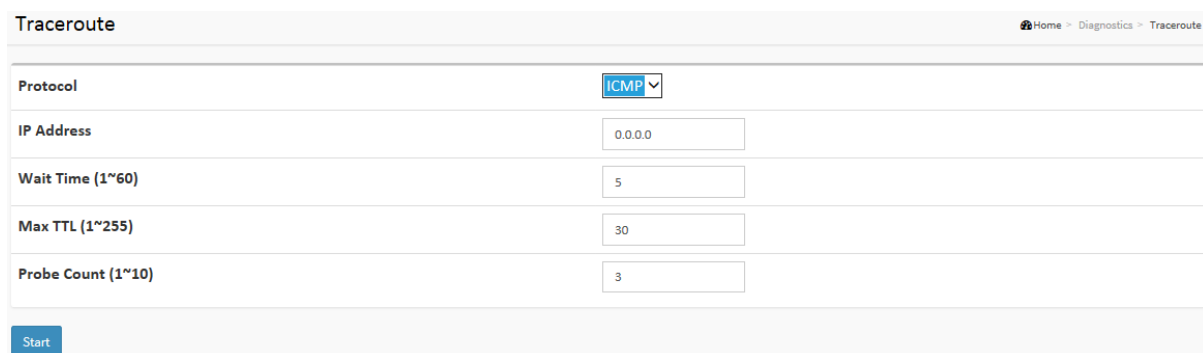

The screenshot shows the 'Traceroute' configuration page. At the top right, there is a breadcrumb trail: Home > Diagnostics > Traceroute. The main configuration area contains the following fields:

Protocol	ICMP
IP Address	0.0.0.0
Wait Time (1~60)	5
Max TTL (1~255)	30
Probe Count (1~10)	3

At the bottom left of the configuration area, there is a blue 'Start' button.

Parameter description:

- **Protocol :**
The protocol(ICMP, UDP, TCP) packets to send.
- **IP Address :**
The destination IP Address.
- **Wait Time :**
Set the time (in seconds) to wait for a response to a probe (default 5.0 sec). Values range from 1 to 60. The payload size of the ICMP packet. Values range from 2 bytes to 1452 bytes.
- **Max TTL :**
Specifies the maximum number of hops (max time-to-live value) traceroute will probe. Values range from 1 to 255. The default is 30.
- **Probe Count :**
Sets the number of probe packets per hop. Values range from 1 to 10. The default is 3.

This chapter describes the entire switch Maintenance configuration tasks to enhance the performance of local network including Restart Device, Firmware upgrade, Save/Restore, Import/Export.

6-1 Restart Device

This section describes how to restart switch for any maintenance needs. Any configuration files or scripts that you saved in the switch should still be available afterwards.

Web Interface

To configure a Restart Device Configuration in the web interface:

1. Click Restart Device.
2. Click Yes.

Figure 6-1: Restart Device

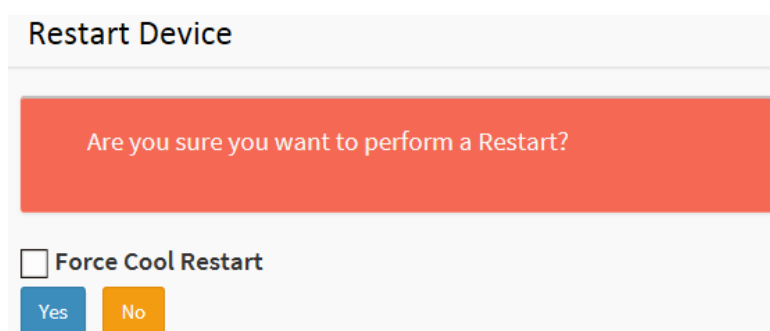

Parameter description:

- **Restart Device :**
You can restart the switch on this page. After restart, the switch will boot normally.
- **Buttons:**
 - Yes** – Click to “Yes” then the device will restart.
 - No** - Click to undo any restart action.

6-2 Factory Defaults

This section describes how to reset the Switch configuration to Factory Defaults. Any configuration files or scripts will recover to factory default values.

Web Interface

To configure a Factory Defaults Configuration in the web interface:

1. Click Factory Defaults.
2. Click Yes.

Figure 6-2.1: The Factory Defaults

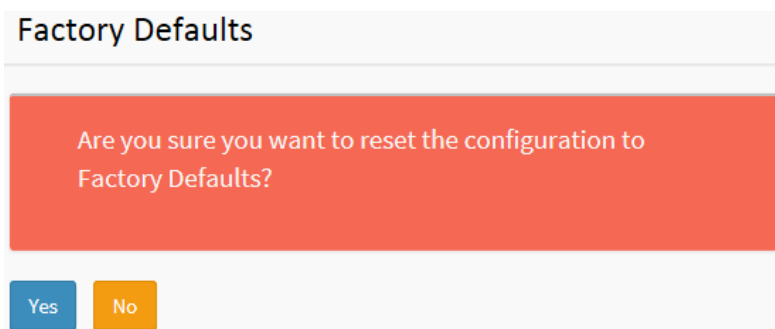

Parameter description:

- **Buttons:**

Yes – Click to "Yes" button to reset the configuration to Factory Defaults.

No - Click to to return to the Port State page without resetting the configuration.

6-3 Firmware

This section describes how to upgrade Firmware. The Switch can be enhanced with more value-added functions by installing firmware upgrades.

6-3.1 Download

This page facilitates an update of the firmware controlling the switch..

Web Interface

To configure a Firmware Upgrade Configuration in the web interface:

1. Click Browser to select Maintenance/Software in you device.
2. Click Download.

Figure 6-3.1 The firmware Download



Parameter description:

- **Browse :**

Click the "Browse..." button to search the Firmware URL and filename.



NOTE: This page facilitates an update of the firmware controlling the switch. Uploading software will update all managed switches to the location of a software image and click. After the software image is uploaded, a page announces that the firmware update is initiated. After about a minute, the firmware is updated and all managed switches restart. the switch restarts.



WARNING: While the firmware is being updated, Web access appears to be defunct. The front LED flashes Green/Off with a frequency of 10 Hz while the firmware update is in progress. Do not restart or power off the device at this time or the switch may fail to function afterwards.

6-3.2 Software Image Select

This page provides information about the active and alternate (backup) firmware images in the device, and allows you to revert to the alternate image.

The web page displays two tables with information about the active and alternate firmware images.

Note:

1. In case the active firmware image is the alternate image, only the "Active Image" table is shown. In this case, the Activate Alternate Image button is also disabled.
2. If the alternate image is active (due to a corruption of the primary image or by manual intervention), uploading a new firmware image to the device will automatically use the primary image slot and activate this.
3. The firmware version and date information may be empty for older firmware releases. This does not constitute an error.

Web Interface

To configure a Firmware Upgrade Configuration in the web interface:

1. Click Browser to select Maintenance/Software in you device.
2. Click Image Select.

Figure 6-3.2 The Firmware selection

Software Image Selection	
Active Image	
Image	managed
Version	GEPoEL2P-ESW26G (standalone) v6.03
Date	2014-09-30T16:10:26+08:00
Alternate Image	
Image	managed.bk
Version	
Date	
<input type="button" value="Activate Alternate Image"/> <input type="button" value="Cancel"/>	

Image Information

- **Image**

The flash index name of the firmware image. The name of primary (preferred) image is image, the alternate image is named image.bk.

- **Version**

The version of the firmware image.

- **Date**

The date where the firmware was produced.

- **Buttons**

Activate Alternate Image: Click to use the “Activate Alternate Image”. This button may be disabled depending on system state.

Cancel: Cancel activating the backup image. Navigates away from this page.

6-4 Configuration

The switch stores its configuration in a number of text files in CLI format. The files are either virtual (RAM-based) or stored in flash on the switch.

There are three system files:

- **running-config:** A virtual file that represents the currently active configuration on the switch. This file is volatile.
- **startup-config:** The startup configuration for the switch, read at boot time.
- **default-config:** A read-only file with vendor-specific configuration. This file is read when the system is restored to default settings.

It is also possible to store up to two other files and apply them to running-config, thereby switching configuration.

6-4.1 Save startup-config

This copy running-config to startup-config, thereby ensuring that the currently active configuration will be used at the next reboot.

Web Interface

To save running configuration in the web interface:

1. Click Browser to select Maintenance/Configuration in you device.
2. Click Apply Startup-Config Select.

Figure 6-4.1: The Save Startup Configuration

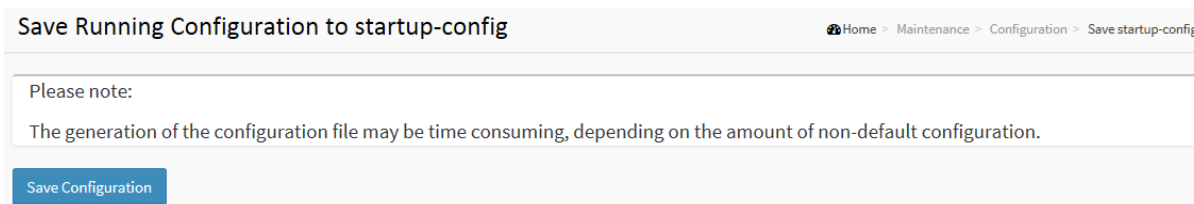

Parameter description:

- **Buttons :**

Save Configuration: Click to save configuration, the running configuration will be written to flash memory for system boot up to load this startup configuration file.

6-4.2 Upload

The configuration upload function will be backed up and saved configuration from the switch's configuration into the running web browser PC.

It is possible to upload any of the files on the switch to the web browser. Select the file and click Upload of running-config may take a little while to complete, as the file must be prepared for upload.

Web Interface

To upload configuration in the web interface:

1. Click Browser to select Maintenance/Configuration in you device.
2. Click upload Select.

Figure 6-4.2: Configuration upload

Upload Configuration

File to Upload	<input style="width: 90%;" type="text"/>	Browse...
Destination File		
File Name	Parameters	
<input type="radio"/> running-config	<input checked="" type="checkbox"/> Replace <input type="checkbox"/> Merge	
<input type="radio"/> startup-config		
<input type="radio"/> Create new file	<input style="width: 100%;" type="text"/>	

There are three system files:

1. running-config: A virtual file that represents the currently active configuration on the switch. This file is volatile.
2. startup-config: The startup configuration for the switch, read at boot time.
3. default-config: A read-only file with vendor-specific configuration. This file is read when the system is restored to default settings.

Parameter description:

- **Buttons :**

Upload Configuration: Click the "Upload" button then the running web management PC will start to upload the configuration from the managed switch configuration into the location PC, user can configure web browser's upload file path to keep configuration file.

6-4.3 Download

This section describes to export the Switch Configuration for maintenance needs. Any current configuration files will be exported as text format.

It is possible to download a file from the web browser to all the files on the switch, except default-config, which is read-only.

Select the file to download, select the destination file on the target, then click .

If the destination is running-config, the file will be applied to the switch configuration. This can be done in two ways:

- Replace mode: The current configuration is fully replaced with the configuration in the downloaded file.
- Merge mode: The downloaded file is merged into running-config.

If the file system is full (i.e. contains the three system files mentioned above plus two other files), it is not possible to create new files, but an existing file must be overwritten or another deleted first.

Web Interface

To download configuration in the web interface:

3. Click Browser to select Maintenance/Configuration in you device.
4. Click Download Select.

Figure 6-4.3: Configuration Download

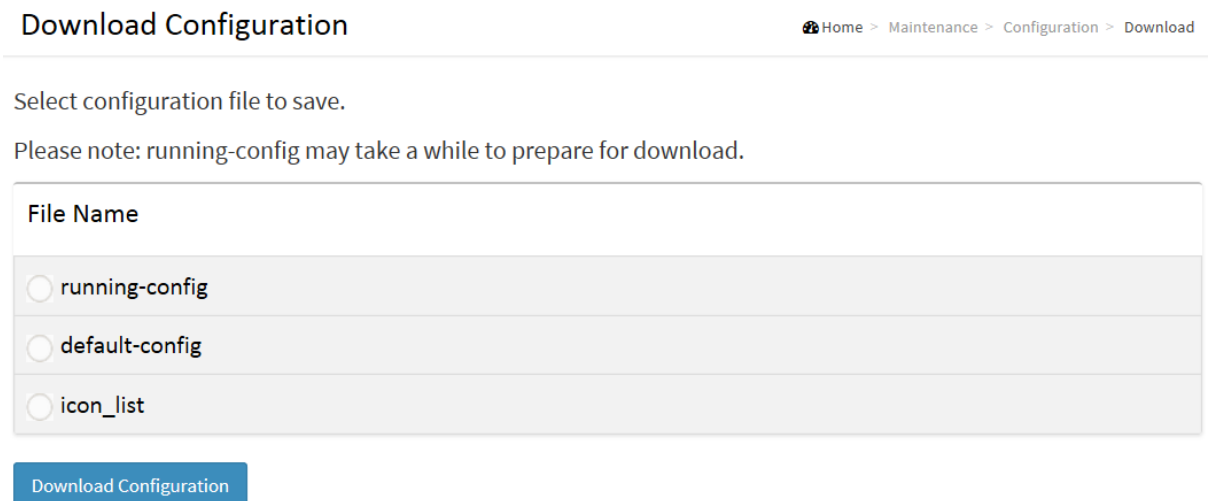

Parameter description:

- **Browse :**

Click the "Browse..." button to search the configuration text file and filename.

- **Download:**

Click the "Download" button then the switch will start to download the configuration from configuration stored location PC or Server.

6-4.4 Activate

It is possible to activate any of the configuration files present on the switch, except for running-config which represents the currently active configuration.

Select the file to activate and click. This will initiate the process of completely replacing the existing configuration with that of the selected file.

Web Interface

To activate configuration in the web interface:

5. Click Browser to select Maintenance/Configuration in you device.
6. Click Activate Select.

Figure 6-4.4: Configuration Activation

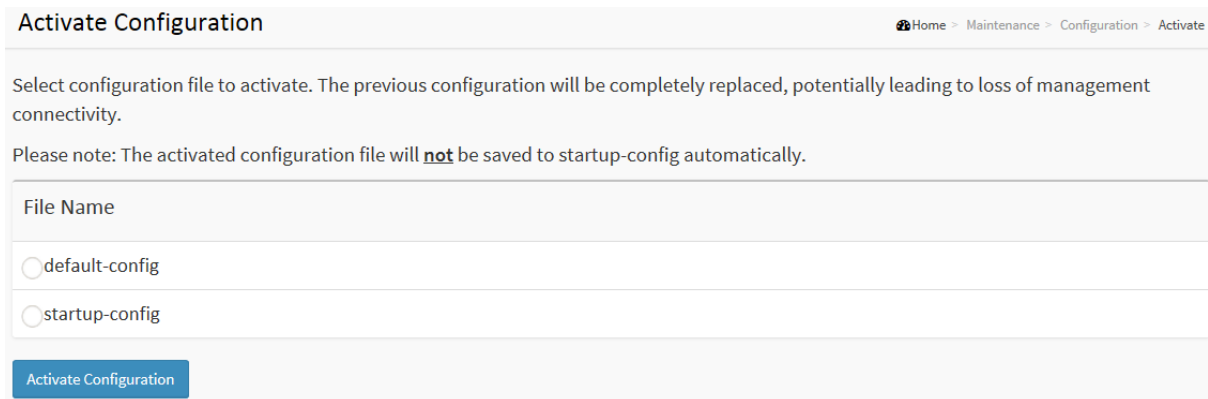

Activate Configuration Home > Maintenance > Configuration > Activate

Select configuration file to activate. The previous configuration will be completely replaced, potentially leading to loss of management connectivity.

Please note: The activated configuration file will **not** be saved to startup-config automatically.

File Name

default-config

startup-config

Activate Configuration

There are two system files:

1. default-config: A read-only file with vendor-specific configuration. This file is read when the system is restored to default settings.
2. startup-config: The startup configuration for the switch, read at boot time.

Parameter description:

- **Buttons :**

Activate Configuration: Click the “Activate” button then the default-config or startup-config file will be activated and to be this switch's running configuration.

6-4.5 Delete

It is possible to delete any of the writable files stored in flash, including startup-config. If this is done and the switch is rebooted without a prior Save operation, this effectively resets the switch to default configuration.

Web Interface

To delete configuration in the web interface:

7. Click Browser to select Maintenance/Configuration in you device.
8. Click Delete Select.

Figure 6-4.5: Delete Configuration

Delete Configuration File Home > Maintenance > Configuration > Delete

Select configuration file to delete.

File Name
<input type="radio"/> icon_list
<input type="radio"/> filename: <input style="width: 150px;" type="text"/>

[Delete Configuration File](#)

There is one system files:

1. startup-config: The startup configuration for the switch, read at boot time.
- 2.

Parameter description:

- **Buttons :**

Delete Configuration: Click the “Delete” button then the startup-config file will be deleted, this effectively resets the switch to default configuration.

 **IMPORTANT:**

1. It is recommended to use **IE10** or **IE11** to open a web console with the PoE switch.
2. This PoE switch is specifically designed for surveillance applications. It comes with an integrated Surveillance interface for ease of configuration. The Surveillance interface is accessed through a tabbed menu, and the configuration changes made in its window have a higher priority than those in the Switch configuration menus.

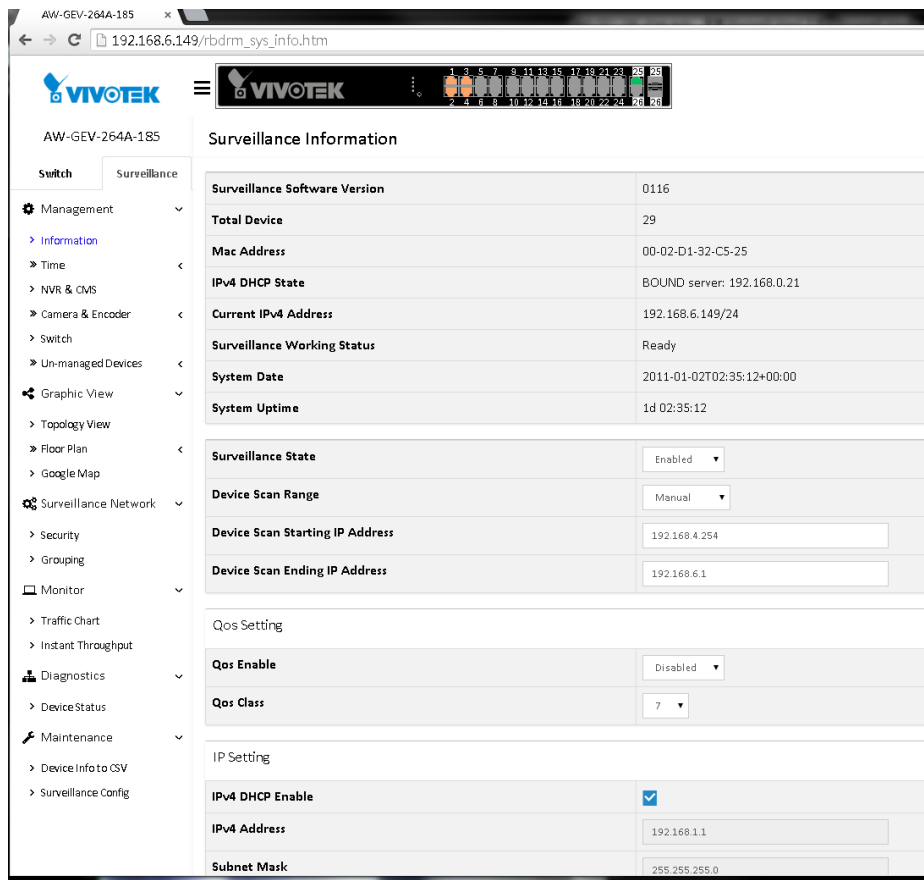

3. You should save the configuration changes made on the Surveillance menus before leaving the web page. Otherwise, the configuration changes will be lost. The save button is located on the upper right corner of the screen.

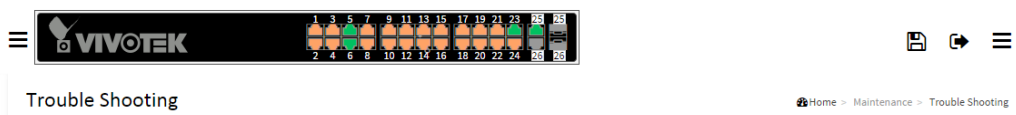

Whenever changes are made, the Save button will turn blue. Click to save your configuration on this page.



Another 2 buttons allow you to logout the current session and access the technical support information.

7-1 Information

The Information page shows general system information for the PoE Surveillance Switch including its Surveillance software version, the number of devices to be managed, MAC Address, Surveillance Working Status, and the current IP Address for the Switch.

Web interface

To configure Surveillance Information in the web interface:

1. Click Surveillance, Management, and Information.
2. Select whether to enable or disable the **Surveillance State**. If there are multiple surveillance switches in your network, you can start your configuration from one surveillance switch selected as the root switch. The other surveillance switches can be deployed as subordinate switches. Enable the Surveillance State on the root switch, and the configuration will automatically apply to its subordinates.

For example, subordinate switches can be automatically detected on the network. As illustrated below, you can configure a VLAN that span across multiple switches. Configuration is made on the root switch only. In this way, the configuration of the entire surveillance network is made easy.

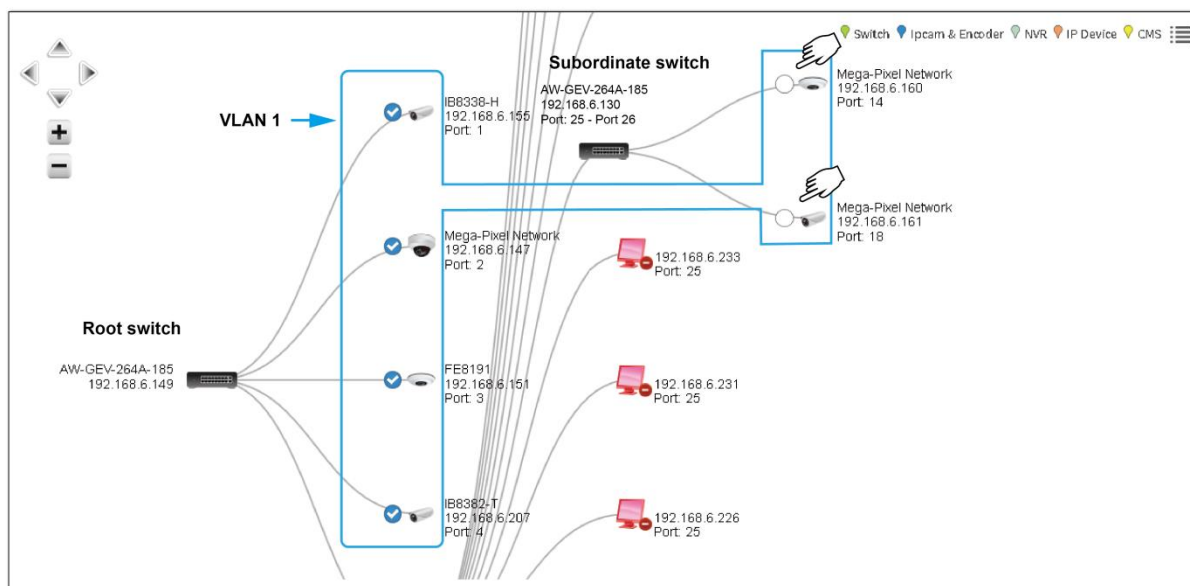

The QoS and Mac-Lock functions also apply to this multi-switch configuration. Configuration is automatically synchronized among surveillance switches.

Device Scan range – The max. number of devices in a surveillance switch deployment is 1,024. If set to **Automatic**, the IP range is 192.168.1.1 ~ 192.168.1.254 with a Subnet Mask of 255.255.255.0.

If the **Manual** mode is selected, the device scan can extend through 4 Class C subnets, e.g., 192.168.1.1 ~ 192.168.4.254 with a Subnet Mask of 255.255.252.0.

Note that a device scan will take up to 20 milliseconds to complete with a device range of 1,024 devices.

You should then specify the Starting and Ending IP addresses. All VIVOTEK network devices will be discovered by the device scan.

3. Specify the QoS setting. 0 has the lowest priority, 7 the highest. Quality of Service (QoS) prioritizes and reserves network capacity for mission-critical video. Assigning a high priority to video traffic ensures its timely delivery.

4. Make configuration changes and then click the Apply button.

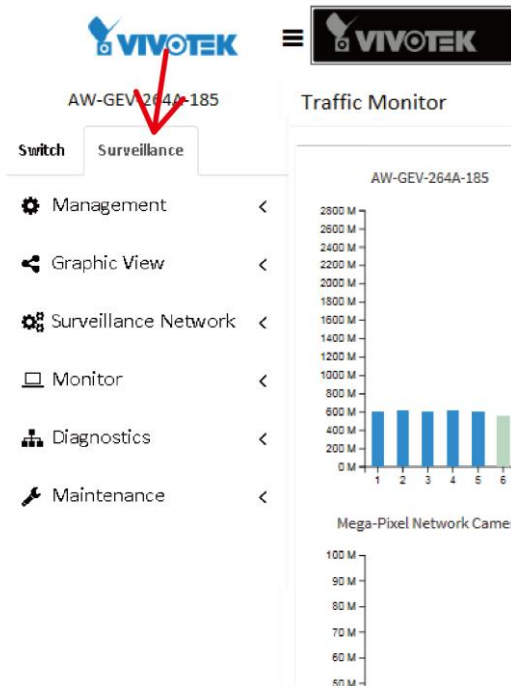

Figure 7-1.1: Surveillance Information

See below for the parameters of all surveillance-related information.

Surveillance Information

Surveillance Software Version	0116
Total Device	29
Mac Address	00-02-D1-32-C5-25
IPv4 DHCP State	BOUND server: 192.168.0.21
Current IPv4 Address	192.168.6.149/24
Surveillance Working Status	Ready
System Date	2011-01-02T02:43:10+00:00
System Uptime	1d02:43:10
Surveillance State	Enabled
Device Scan Range	Manual
Device Scan Starting IP Address	192.168.4.254
Device Scan Ending IP Address	192.168.6.1
Qos Setting	
Qos Enable	Disabled
Qos Class	7
IP Setting	
IPv4 DHCP Enable	<input checked="" type="checkbox"/>
IPv4 Address	192.168.1.1
Subnet Mask	255.255.255.0
DNS Server	Configured 168.95.1.1
DNS Proxy	<input type="checkbox"/>
DHCP Server Setting	
DHCP Server	Disabled
IP Pool Starting Address	192.168.1.1
Size of Pool	254

Apply

Parameter description:

- **Surveillance Software Version:**

Displays the current surveillance firmware version number.
- **Total Device:**

Displays the number of devices in your topology.
- **MAC Address:**

The MAC Address of this switch.
- **IPv4 DHCP State:**

The current DHCP status showing whether the DHCP client status is enabled.
- **Current IPv4 Address:**

The current address (IPv4). Surveillance uses switch interface VLAN1 as default.
- **Surveillance Working Status:**

The current switch working condition.
- **System Date:** The current system date and time zone.
- **System Uptime:** How long has the system been operating.
- **Surveillance State:** Displays whether the Surveillance mode has been activated, see previous pages for details.
- **Device Scan Range:** See previous pages for details.
- **Device Scan Starting IP Address:** In the Manual mode, enter a starting address for the address scan, e.g., 192.168.1.1.
- **Device Scan Ending IP Address:** In the Manual mode, enter an end address for the address scan, e.g., 192.168.4.254.
- **QoS Enable:** Select to enable or disable the QoS setting for mission-critical video.
- **QoS Class:** Select the priority for the QoS setting. #7 has the highest priority.
- **IP Setting:**
- **IPv4 DHCP Enable:**

Enables the DHCP client mode setting for listening to a DHCP server in the local network.
- **IPv4 Address:**

The IPv4 address of the interface VLAN1.
- **Subnet mask:**

The IPv4 network mask of the interface VLAN1.
- **DNS Server:**

Select the source of DNS service.

 1. From any DHCP interfaces: as provided by a router offering the DHCP service.
 2. No DNS server.
 3. Configured: User defined.
 4. From this DHCP interface: If a router exists in a specific VLAN configuration, listen to the particular router for the DNS service.
- **DNS Proxy:**

Select this checkbox if access to the DNS server is made via a Proxy.

DHCP Server Setting	
DHCP Server	Disabled ▼
IP Pool Starting address	0.0.0.0
Size of Pool	0

Apply

- **DHCP Server Setting:**

If you want to enable the embedded DHCP server, deselect the “IPv4 DHCP Enable” (Client) checkbox.

The DHCP (Dynamic Host Configuration Protocol) default is disabled. If you join the switch into an established network, make sure the DHCP server is disabled. For an unmanaged network, you can enable the DHCP server function and let it manage the IP addresses of devices attached to the switch.



IMPORTANT:

1. If you attach the PoE switch to a network that is already managed by a DHCP server, IP conflicts will occur. You should then disable the onboard DHCP server first.
2. If you have a 264A switch up and running and enabled its DHCP function, you should disable the DHCP server on another 264A PoE switch if you need to join it to your network. Multiple 264A switches can be managed in the same network using a Master-slave configuration. Therefore, except the Master/Root switch, disable the Surveillance state function on other PoE switches.

- **IP Pool Starting address:**

The starting address of IPv4 address for the interface VLAN1, e.g., 192.168.x.x.

- **Size of Pool:**

The IPv4 network size: can be a number starting from 1 to 254.

7-2 Time

The switch provides manual and automatic ways to set the system time via NTP. Manual setting is simple and you just input “Year”, “Month”, “Day”, “Hour” and “Minute” within the valid value range indicated in each item.

Web Interface

To configure Time in the web interface:

1. Click Surveillance > Management > Time.
2. Specify the Time parameter.
3. Click Apply.

Figure 7-2.1: The time configuration

Time Configuration	
Time Configuration	
Clock Source	Use Local Settings <input type="button" value="v"/>
System Date	2011-01-01 01:04:59 (yyyy-mm-dd hh:mm:ss)

Time Zone Configuration	
Time Zone	None <input type="button" value="v"/>
Acronym	<input type="text"/> (0 - 16 characters)

Daylight Saving Time Configuration	
Daylight Saving Time	Disabled <input type="button" value="v"/>
Start Time settings	
Month	Jan <input type="button" value="v"/>
Date	1 <input type="button" value="v"/>
Year	2000 <input type="button" value="v"/>
Hours	0 <input type="button" value="v"/>
Minutes	0 <input type="button" value="v"/>
End Time settings	
Month	Jan <input type="button" value="v"/>
Date	1 <input type="button" value="v"/>
Year	2000 <input type="button" value="v"/>
Hours	0 <input type="button" value="v"/>
Minutes	0 <input type="button" value="v"/>
Offset settings	
Offset	1 (1 - 1440) Minutes

Parameter description:

Time Configuration

- **Clock Source:**

There are two modes for configuring how the Clock Source from. Select "Use Local Settings;" Clock Source from Local Time. Select "Use NTP Server;" Clock Source from NTP Server.

- **System Date:**

Displays the current time of the system. The year of system date limits between 2011 and 2037.

Time Zone Configuration

- **Time Zone:**

Lists various Time Zones worldwide. Select an appropriate Time Zone from the drop down and click Apply to set.

- **Acronym:**

User can set the acronym of the time zone. This is a User configurable acronym to identify the time zone. (Range : Up to 16 characters)

Daylight Saving Time Configuration

- **Daylight Saving Time:**

This is used to set the clock forward or backward according to the configurations set below for a defined Daylight Saving Time duration. Select 'Disable' to disable the Daylight Saving Time configuration. Select 'Recurring' and configure the Daylight Saving Time duration to repeat the configuration every year. Select 'Non-Recurring' and configure the Daylight Saving Time duration for single time configuration. (Default: Disabled).

Recurring Configuration

- **Start time settings:**

Week - Select the starting week number.

Day - Select the starting day.

Month - Select the starting month.

Hours - Select the starting hour.

Minutes - Select the starting minute.

- **End time settings:**

Week - Select the ending week number.

Day - Select the ending day.

Month - Select the ending month.

Hours - Select the ending hour.

Minutes - Select the ending minute.

- **Offset settings:**

Offset - Enter the number of minutes to add during Daylight Saving Time. (Range: 1 to 1440)



NOTE: The under "Start Time Settings" and "End Time Settings" was displayed what you set on the "Start Time Settings" and "End Time Settings" field information.

- **Buttons**

These buttons are displayed on the NTP page:

Apply – Click to save changes.

Reset - Click to undo any changes made locally and revert to previously saved values.

NTP:

- **Mode:** Enable or disable the NTP time server function.
- **Server #:** Enter the addresses of one or multiple time servers. The entry field supports both domain name and IP address.

Note that the time zone setting in the Management Information\Time\Manual page should be properly configured when you enable the NTP server setting.

7-3 VVTK NVR & CMS

You can identify the system by configuring switch contact information, name, and location.



Web interface

To configure Surveillance VVTK NVR & CMS on the web interface:

1. Click Surveillance > Management > VVTK NVR & CMS.
2. Make configuration changes and click the Apply button.

Figure 7-3.1: Surveillance NVR & CMS

VVTK NVR & CMS Device

Auto-refresh  

34 ON-LINE 14 OFF-LINE 6 MANAGED 42 UN-MANAGED

Show entries

<input type="checkbox"/> Remove	Status	Model Name	Device Name	MAC	IP Address
<input type="checkbox"/>	Off Line	ND8422P		00-02-D1-C4-2A-17	169.254.11.235
<input type="checkbox"/>	Off Line	VAST		34-E6-D7-2E-91-70	192.168.6.104
<input type="checkbox"/>	Off Line	VAST		EC-F4-BB-50-31-DA	192.168.6.128
<input type="checkbox"/>	On Line	VAST		20-CF-30-54-51-A7	192.168.6.205
<input type="checkbox"/>	On Line	VAST		20-CF-30-42-A1-05	192.168.6.213
<input type="checkbox"/>	On Line	ST7501		00-21-70-CA-9E-7F	192.168.6.225

Showing 1 to 6 of 6 entries



IMPORTANT: The surveillance switch automatically discovers all devices in the local area network, and there are differences for these devices in terms of VLAN configurations:

1. NVR and CMS stations can join multiple VLAN Groups.
2. Each of the IP cameras and video encoders can join a single VLAN Group.

Unmanaged devices refer to those protected by unknown root passwords, which you do not have the access credentials.

Parameter description:

- **Remove:**
Select the checkbox and click Apply to remove an off-Line device from the list. An online device cannot be removed.
- **Status:**
Device link state (On/Off Line).
- **Model Name:**
NVR & CMS model name.
- **Device Name:**
NVR & CMS device name.
- **Edit Device Name:**
NVR & CMS device name edit function.
- **MAC:**
NVR & CMS device MAC address.
- **IP Address:**
NVR & CMS device IP address. It is also a hyper-link that directly opens a web session with the device.
- **Version:**
NVR & CMS device software version.

Note that if the Auto-refresh checkbox is selected, the device status is refreshed by every 3 seconds. If you want to Remove a detected device, deselect the Auto-refresh checkbox first.

7-4 VVTK Camera & Encoder

This page displays the status of all IP Cameras and video servers currently connected to your switch as well as all the devices in the network that the switch can access.

Web interface

To configure Surveillance Camera & Encoder in the web interface:





1. Click Surveillance > Management > Camera & Encoder > Device List.
2. Click  to configure the **Batch Account Setting** web page for a common user name and password for multiple managed devices.
3. Click on a device's MAC address to configure the General Network setting.
4. Click the **Apply** button for the configuration to take effect.
5. A click on the IP address opens a web console with the IP camera (or video server).

Figure 7-4.1: Surveillance Camera & Encoder

WTK Camera & Encoder Device List Home > Management > Camera & Encoder

Auto-refresh    8 ON-LINE 0 OFF-LINE 7 MANAGED 1 UN-MANAGED

[Removed](#) [Reboot](#) [Restore Default](#) [Translate dynamic IP to static IP](#)

Device List

10 records per page Search:

Select	Status	Model Name	Device Name	MAC	IP Address	IP State	Version
<input type="checkbox"/>	On Line	PD8136	PD8136	00-02-D1-29-64-CF	169.254.100.207	Static	0101b
<input type="checkbox"/>	On Line	IP8364	IP8364	00-02-D1-28-72-E7	169.254.114.231	Dynamic	0101a
<input type="checkbox"/>	On Line	IP8337H		00-02-D1-27-B2-98	169.254.178.152	Static	0101a
<input type="checkbox"/>	On Line	FD8134	aabbcc	00-02-D1-28-C9-AB	169.254.201.171	Static	0301c
<input type="checkbox"/>	On Line	IP8335H	Mega-Pixel Network Camera	00-02-D1-2D-F0-F6	169.254.240.246	Static	0204c
<input type="checkbox"/>	On Line	IP8362		00-02-D1-2D-07-FD	169.254.7.253	Static	0200d
<input type="checkbox"/>	On Line	IP8362		00-02-D1-2D-08-D4	169.254.8.212	Static	0200d

Showing 1 to 7 of 7 entries Previous **1** Next

Batch Account Setting Home > Management > Camera & Encoder

User name:

Password:

Confirm password:

10 records per page Search:

Select	Model Name	Device Name	MAC	IP Address
<input type="checkbox"/>	PD8136	PD8136_1	00-02-D1-29-64-CF	169.254.100.207
<input type="checkbox"/>	IP8362	IP8362_1	00-02-D1-2D-08-D4	192.168.0.3

Showing 1 to 2 of 2 entries Previous **1** Next

[Apply](#) [Cancel](#)

IP8152

Device Name	<input type="text" value="Mega-Pixel Network Camera"/>
Auto Configuration	<input type="text" value="DHCP"/>
IP Address	<input type="text" value="192.168.1.2"/>
Subnet Mask	<input type="text" value="255.255.255.0"/>
Default Gateway	<input type="text" value="192.168.1.253"/>
Primary DNS Server	<input type="text"/>
Secondary DNS Server	<input type="text"/>
Root password	<input type="text"/>
Confirm Root password	<input type="text"/>

Parameter description:

- **Select:**
Use the checkbox in the Select column to Remove, Reboot, or restore the Default of a device.
- **Status:**
Device link state (On/Off Line)
- **Model Name:**
Camera & Encoder model name
- **Device Name:**
Camera & Encoder device name
- **Edit Device Name:**
Camera & Encoder device name edit
- **MAC:**
Camera & Encoder device MAC address. It is also a hyper-link that opens the device's General Network Setting page.
- **IP Address:**
Camera & Encoder device IP address. It is also a hyper-link that opens a web session with the device where you can configure the device firmware options.
- **IP State:**
Dynamic IP or Static IP.
- **Version:**
Camera & Encoder device's firmware version
- **Root Password:**
Change the camera & Encoder Root Password (1~12 characters)
- **Confirm Password:**
Confirm the camera and Encoder Root Password (1~12 characters)

Functional buttons



Figure 7-4.2: Surveillance Information



The connection status is shown by an interactive front view. PoE ports shown in orange indicate the ports connected to powered devices, i.e., IP cameras. Other color codes indicate the connection to other devices.

Figure 7-4.3: Device Status and Functional Buttons



- **Refresh** : Refresh and poll the connection statuses from the connected devices. You may also select the Auto-refresh checkbox. The switch will update the connection status by every one second.
- **Edit device name** : Click the button. The device Name of IP cameras will become editable. You can then enter a new name in the text box.
- **Batch Account Setting** : Click the button to open a Batch Account window. In there, you can enter a common User name and Password, and apply them to multiple cameras for ease of management.
- **Remove:** Select the checkbox in front of a device, and then click the Remove button to remove a device from the list.
- **Reboot:** Select the checkbox in front of a device, and then click the Reboot button to re-start a device. Rebooting a device can sometimes restore an IP camera from a faulty state.
- **Restore Default:** Select the checkbox in front of a device, and then click the Restore default button to restore its firmware default.
- **Translate dynamic IP to static IP:** By default, VIVOTEK's IP cameras listen to a DHCP server for a dynamic IP. This button sets their dynamic IPs (that are currently in use) into static IPs. Using a static IP can avoid the change of IPs when devices need to be re-started.



NOTE: The Search function on the Device list page supports search entry by Model Name, MAC address, or IP addresses.

7-5 Camera Upgrade

This section describes how to upgrade Camera firmware. Revisions of camera firmware can be available through time to enhance functionality. If you have multiple cameras of the same model, you can upgrade their firmware in one process.

Web interface

To configure Surveillance Camera Upgrade in the web interface:

1. Click Surveillance > Management > Camera & Encoder > Camera Upgrade.
2. Click “Select Device” to enter the selected page.
3. Click “Choose File” to select firmware from the client computer.
4. Single or multiple clicks on their checkboxes to select cameras.
5. Click Apply to upload the firmware to the switch buffer.
6. You can select “Start Upgrade” by Schedule time or select Right Now to immediately start the upgrade process.

Figure 7-5.1: Camera upgrade

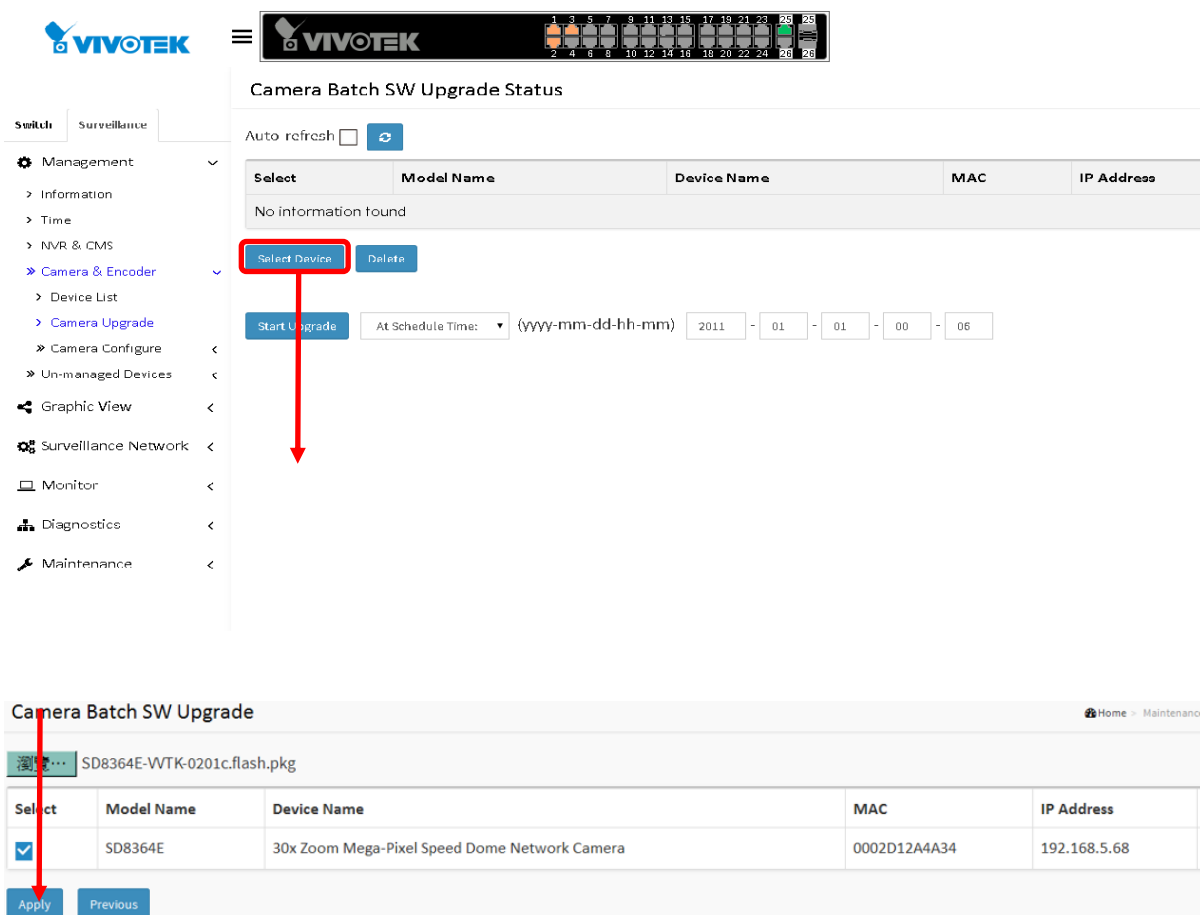

The screenshot shows the VIVOTEK web interface for the 'Camera Batch SW Upgrade Status' page. The interface includes a navigation menu on the left with options like 'Management', 'Information', 'Time', 'NVR & CMS', 'Camera & Encoder', 'Device List', 'Camera Upgrade', 'Camera Configure', 'Un-managed Devices', 'Graphic View', 'Surveillance Network', 'Monitor', 'Diagnostics', and 'Maintenance'. The main content area features an 'Auto refresh' checkbox and a table with columns for 'Select', 'Model Name', 'Device Name', 'MAC', and 'IP Address'. Below the table are buttons for 'Select Device' and 'Delete', a 'Start Upgrade' button, and a schedule time selector. A red arrow points from the 'Select Device' button to the 'Apply' button in the second screenshot.

Camera Batch SW Upgrade Status

Auto refresh 

Select	Model Name	Device Name	MAC	IP Address
No information found				

At Schedule Time: 2011 - 01 - 01 - 00 - 06

Camera Batch SW Upgrade Home > Maintenance

Select	Model Name	Device Name	MAC	IP Address
<input checked="" type="checkbox"/>	SD8364E	30x Zoom Mega-Pixel Speed Dome Network Camera	0002D12A4A34	192.168.5.68

7-6 Camera Configure

7-6.1 Config Export

Web interface

To configure Surveillance Information in the web interface:

1. Click Surveillance > Management > Camera & Encoder > Config Export
2. Select the Device to export the configuration file from. You can export IP cameras' configuration profile (128KB in size) to the client computer or to the switch itself. Note that if you choose to export to the switch, you can store up to 39 copies of camera configuration profile.

The Search box supports filtering find of devices using Model Name, MAC address, or IP addresses.

IMPORTANT: If you need to export the configuration to a client computer, a TFTP server is required in your network. The configuration profile is transported via a TFTP server.

Camera Config Export

Export to: Please Input TFTP Server IP:

3. Click Start.

Figure 7-6.1: Config Export

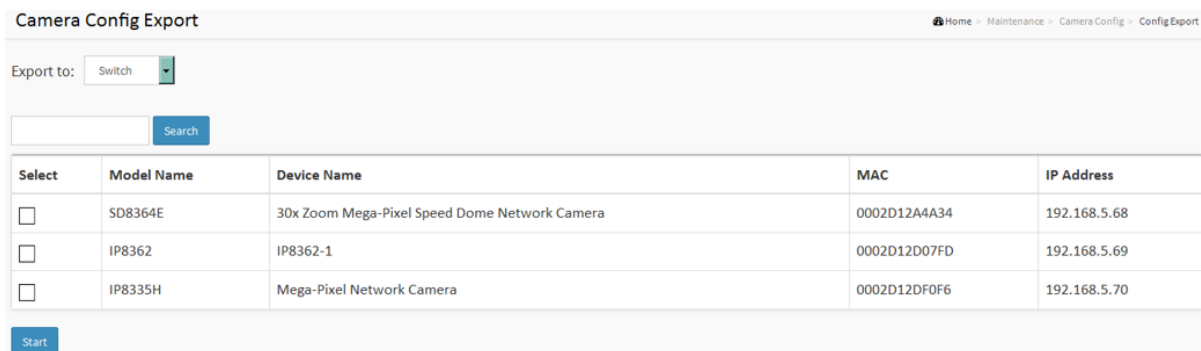

Camera Config Export Home > Maintenance > Camera Config > Config Export

Export to:

Select	Model Name	Device Name	MAC	IP Address
<input type="checkbox"/>	SD8364E	30x Zoom Mega-Pixel Speed Dome Network Camera	0002D12A4A34	192.168.5.68
<input type="checkbox"/>	IP8362	IP8362-1	0002D12D07FD	192.168.5.69
<input type="checkbox"/>	IP8335H	Mega-Pixel Network Camera	0002D12DF0F6	192.168.5.70

7-6.2 Config Import

Web interface

To configure Camera config. in the web interface:

1. Click Surveillance > Management > Camera & Encoder > Camera Configure > Config Import.
2. Select the Device to import the configuration file from (i.e., client PC or the switch itself).
3. Select the IP camera to load the configuration file to, using a single-click on its checkbox.
4. Click the Apply button.

Figure 7-6.2: Config import

Camera Config Import Home > Maintenance > Camera Config > Config Import

Import from: Client PC 未選擇檔案

Select	Model Name	Device Name	MAC	IP Address
<input type="checkbox"/>	IP8337H	IP8337H	0002D127B298	192.168.0.6
<input type="checkbox"/>	IP8364	IP8364	0002D12872E7	192.168.0.5
<input type="checkbox"/>	FD8134	aabbcc	0002D128C9AB	192.168.0.4
<input type="checkbox"/>	PD8136	PD8136	0002D12964CF	169.254.100.207
<input type="checkbox"/>	IP8362	IP8362-1	0002D12D07FD	169.254.7.253
<input type="checkbox"/>	IP8362	Mega-Pixel Network Camera	0002D12D08D4	192.168.0.69
<input type="checkbox"/>	IP8335H	Mega-Pixel Network Camera	0002D12DF0F6	192.168.0.80

7-6.3 Config Files

Web interface

To display configuration files currently stored on the switch:

1. Click Surveillance > Management > Camera & Encoder > Camera Configure > Config File.
2. You can select configuration files and delete these files by selecting their checkboxes, and click the Delete button. Or you may download the configuration file to the client PC using the Download button.
3. You can also export the files to a TFTP server by entering the TFTP address, checking the files to be uploaded, and click the Export To button.

IMPORTANT: If you need to export the configuration to a client computer, a TFTP server is required in your network. The configuration file is transported via a TFTP server.

Figure 7-6.3: Config File

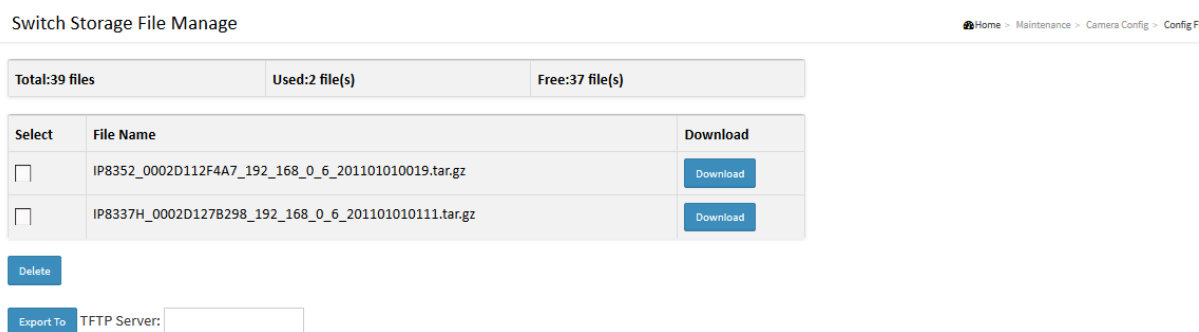

Switch Storage File Manage

Total:39 files Used:2 file(s) Free:37 file(s)

Select	File Name	Download
<input type="checkbox"/>	IP8352_0002D112F4A7_192_168_0_6_201101010019.tar.gz	Download
<input type="checkbox"/>	IP8337H_0002D127B298_192_168_0_6_201101010111.tar.gz	Download

[Delete](#)

[Export To](#) TFTP Server:

7-7 VVTK Switch

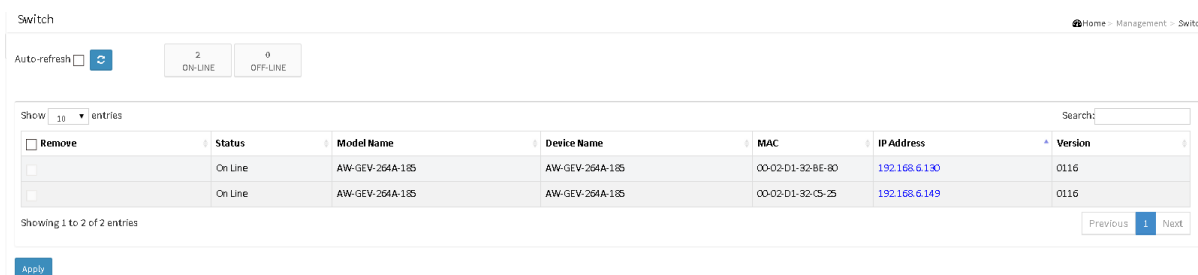

Switch

Auto-refresh

2 ON-LINE 0 OFF-LINE

Show 10 entries

Remove	Status	Model Name	Device Name	MAC	IP Address	Version
<input type="checkbox"/>	On Line	AW-GEV-264A-185	AW-GEV-264A-185	00-02-D1-32-BE-80	192.168.6.130	0116
<input type="checkbox"/>	On Line	AW-GEV-264A-185	AW-GEV-264A-185	00-02-D1-32-C5-25	192.168.6.149	0116

Showing 1 to 2 of 2 entries

[Previous](#) [Next](#)

VIVOTEK's surveillance switches discovered from your network will be listed here. Note that you cannot remove a surveillance switch if it has been configured into a network configuration, e.g., a VLAN. The online switches' IP addresses are hyperlinks. You can open a web console with them using a single click.

In the Search box, Model Name, MAC address, and IP address can be used as the search condition.

7-8 IP Device

This IP device page come from user manual managed device list, it provide a easy way to modify device type (e.g., Un-Managed, NVR & CMS, Camera & Encoder or Other Device)

7-8.1 NVR & CMS

Web interface

To configure Surveillance IP Device > NVR & CMS on the web interface:

4. Click Surveillance > Management > IP Devices > NVR & CMS.
5. Make configuration changes and click the Apply button.

Figure 7-8.1: NVR & CMS Device List

NVR & CMS Device List Home > Management > IP Devices > NVR & CMS

Auto-refresh 

Show entries Search:

<input type="checkbox"/> Remove	Status	Device Name	NVR & CMS	MAC	IP Address
No information found					

Showing 0 to 0 of 0 entries Previous Next

[Apply](#)

Parameter description:

- **Remove:**
Select the checkbox and click Apply to remove an off-Line device from the list. An online device cannot be removed.
- **Status:**
Device link state (On/Off Line).
- **Device Name:**
NVR & CMS device name.
- **Edit Device Type:**
Manual modification to Un-Managed, NVR & CMS, Camera & Encoder or Other Device) into different IP Device or Un-managed Devices page.
- **MAC:**
NVR & CMS device MAC address.
- **IP Address:**
NVR & CMS device IP address. It is also a hyper-link that directly opens a web session with the device.

Note that if the Auto-refresh checkbox is selected, the device status is refreshed by every 3 seconds. If you want to Remove a detected device, deselect the Auto-refresh checkbox first.

7-8.2 Camera & Encoder

Web interface

To configure Surveillance IP Device > Camera & Encoder on the web interface:

1. Click Surveillance > Management > IP Devices > Camera & Encoder.
2. Make configuration changes and click the Apply button.

Figure 7-8.2: Camera & Encoder Device List

Camera & Encoder Device List Home > Management > IP Devices > Camera & Encoder

Auto-refresh 

Show entries Search:

<input type="checkbox"/> Remove	Status	Device Name	Camera & Encoder	MAC	IP Address
No information found					

Showing 0 to 0 of 0 entries Previous Next

[Apply](#)

Parameter description:

- **Remove:**
Select the checkbox and click Apply to remove an off-Line device from the list. An online device cannot be removed.
- **Status:**
Device link state (On/Off Line).
- **Device Name:**
Camera & Encoder device name.
- **Edit Device Type:**
Manual modification to Un-Managed, NVR & CMS, Camera & Encoder or Other Device) into different IP Device or Un-managed Devices page.
- **MAC:**
NVR & CMS device MAC address.
- **IP Address:**
NVR & CMS device IP address. It is also a hyper-link that directly opens a web session with the device.

Note that if the Auto-refresh checkbox is selected, the device status is refreshed by every 3 seconds. If you want to Remove a detected device, deselect the Auto-refresh checkbox first.

7-8.3 Other Device

Web interface

To configure Surveillance IP Device > Other Device on the web interface:

1. Click Surveillance > Management > IP Devices > Other Device.
2. Make configuration changes and click the Apply button.

Figure 7-8.3: Other Device List

Other Device List

Home > Management > IP Devices > Other Device

Auto-refresh 

Show entries Search:

<input type="checkbox"/> Remove	Status	Device Name	Other Device	MAC	IP Address
No information found					

Showing 0 to 0 of 0 entries Previous Next

Apply

Parameter description:

- **Remove:**
Select the checkbox and click Apply to remove an off-Line device from the list. An online device cannot be removed.
- **Status:**
Device link state (On/Off Line).
- **Device Name:**
Other device name.
- **Edit Device Type:**
Manual modification to Un-Managed, NVR & CMS, Camera & Encoder or Other Device) into different IP Device or Un-managed Devices page.
- **MAC:**
NVR & CMS device MAC address.
- **IP Address:**
NVR & CMS device IP address. It is also a hyper-link that directly opens a web session with the device.

Note that if the Auto-refresh checkbox is selected, the device status is refreshed by every 3 seconds. If you want to Remove a detected device, deselect the Auto-refresh checkbox first. 7-9 Un-managed Devices

7-9.1 IP Device

If a device doesn't have DRM Client function, (e.g., PC, NB, or any IP devices,...), the device will be listed as an Un-managed Devices.

Web interface

To configure Surveillance Un-managed Devices IP devices in the web interface:

1. Click Surveillance > Management > Unmanaged Devices > IP Device.

2. Since a network can contain numerous devices, you can remove devices that are not related to your surveillance deployment.

Figure 7-9.1: Un-managed IP Device

Un-managed IP Device

Home > Management > Un-managed Devices > IP Device

Auto-refresh 

Show entries Search:

<input type="checkbox"/> Remove	Status	Device Name	Un-Managed <input type="text"/>	MAC	IP Address
No information found					

Showing 0 to 0 of 0 entries Previous Next

Apply

Parameter description:

- **Remove:**
Select the checkbox and click Apply to remove an off-Line device from the list. An online device cannot be removed.
- **Status:**
Device link state (On/Off Line).
- **Device Name:**
Un-managed IP device name.
- **Edit Device Type:**
Manual modification to Un-Managed, NVR & CMS, Camera & Encoder or Other Device) into different IP Device or Un-managed Devices page.
- **MAC:**
NVR & CMS device MAC address.
- **IP Address:**
NVR & CMS device IP address. It is also a hyper-link that directly opens a web session with the device.

Note that if the Auto-refresh checkbox is selected, the device status is refreshed by every 3 seconds. If you want to Remove a detected device, deselect the Auto-refresh checkbox first.

7-9.2 VVTK Camera

An Un-managed VIVOTEK camera is one that comes with unknown Root password. From this page you can force the change of Root password. When a new Root password is applied, the VIVOTEK camera will become a managed camera.

Web interface

To configure Surveillance Un-managed Devices VVTK Camera in the web interface:

1. Click Surveillance > Management > Unmanaged Devices > VVTK Camera.
2. Enter a Password (blank also applies).
3. Click the Apply button.

Figure 7-9.2: Surveillance Un-managed Devices VVTK Camera

Un-managed Camera Home > Management > Un-managed Devices > Camera

10 records per page Search:

Select	Model Name	MAC	IP Address
<input type="checkbox"/>	PD8136	00-02-D1-28-66-92	192.168.0.20

Showing 1 to 1 of 1 entries Previous 1 Next

Administrator Username:

Password:

Parameter description:

- **Administrator Username:**
Root (system administrator default and cannot be changed).
- **Administrator Password:**
The Root password that will be applied to the selected device(s).

8-1 Topology View

On this page, you can take a glimpse of networked devices and network topology in a cluster of networks. You can also configure a VLAN on a single switch or across multiple switches using the configurable options in the Topology View.

The Auto Sync Feature

In a network deployment consisting of multiple surveillance switches, you can select one switch as the root switch. The rest of the PoE switches will become its subordinates, and the VLAN, QoS, MAC Lock configurations will be automatically synchronized among these switches. The configuration effort is thus minimized.

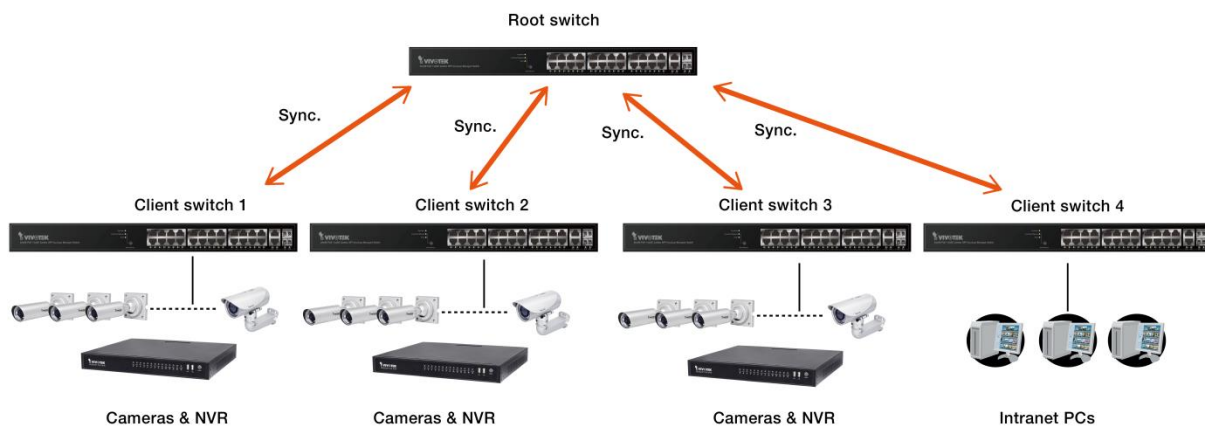

VLAN on the Topology View

A **Virtual LAN (VLAN)** is a broadcast domain that is partitioned and isolated in a network at the data link layer (OSI layer 2). LAN is an abbreviation of Local Area Network. Broadcast packets can be limited to within a VLAN/broadcast domain to avoid broadcast storm.

The surveillance switch supports the following for VLAN configuration:

1. IEE802.1Q Tagged VLAN, especially when a VLAN spans across multiple switches.
2. Port-based VLAN. For example, VLAN1=ports 2, 3, 4, 5; VLAN2=8, 9, 10, 11.
3. MAC-based VLAN. For example, VLAN1=MAC2, MAC3, MAC4, MAC5; VLAN2=MAC8, MAC9, MAC10, MAC11.
4. Protocol-based VLAN. For example, IP, IPX, AppleTalk, NetBIOS, ARP, RARP, PPPoE.
5. IP Subnet-based VLAN. For example, VLAN1=140.114.76.xx; VLAN2=140.114.77xx.

Grouping devices (IP cameras) with a common set of requirements regardless of their physical location by VLAN can greatly simplify network design. A VLAN has the same attributes as a physical local area network (LAN), but it allows end stations to be grouped together more easily even if they are not on the same network switch. To physically replicate the functions of a VLAN would require a separate, parallel collection of network cables and equipment separate from the primary network. However, unlike physically separate networks, VLANs share bandwidth, so VLAN trunks may require aggregated links and /or quality of service prioritization.

VLAN separates surveillance video traffic on existing data network, and reduces broadcast traffic on the network. In addition to this, only authorized users and those who are physically connected to the network can access devices within a VLAN. Below is a sample drawing of 3 VLANs.

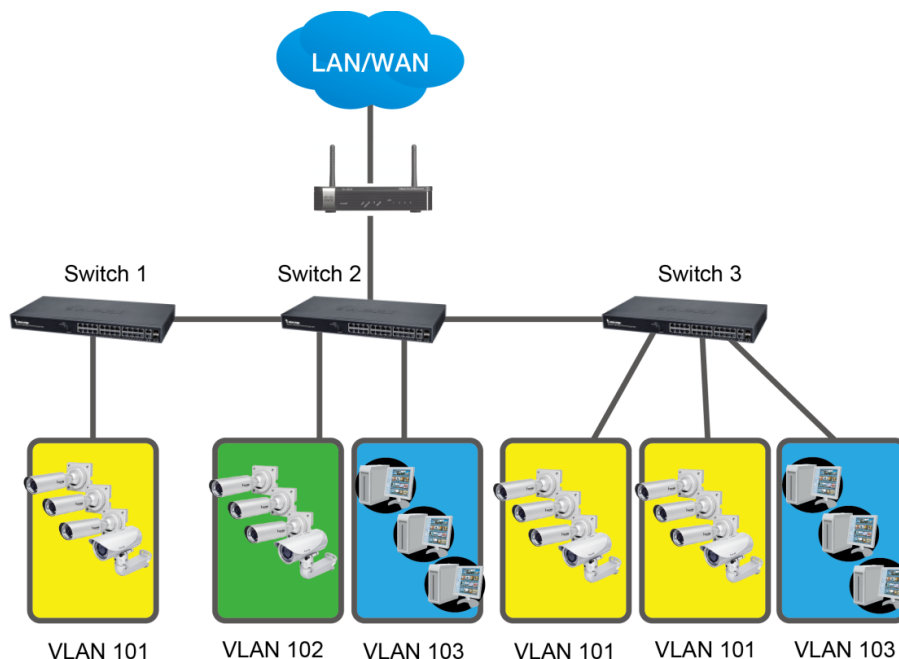

The applications running in a network environment can vary. Segregating network traffic can ensure that the bandwidth for critical video recording is not compromised by the traffic demands for other applications.

Application View

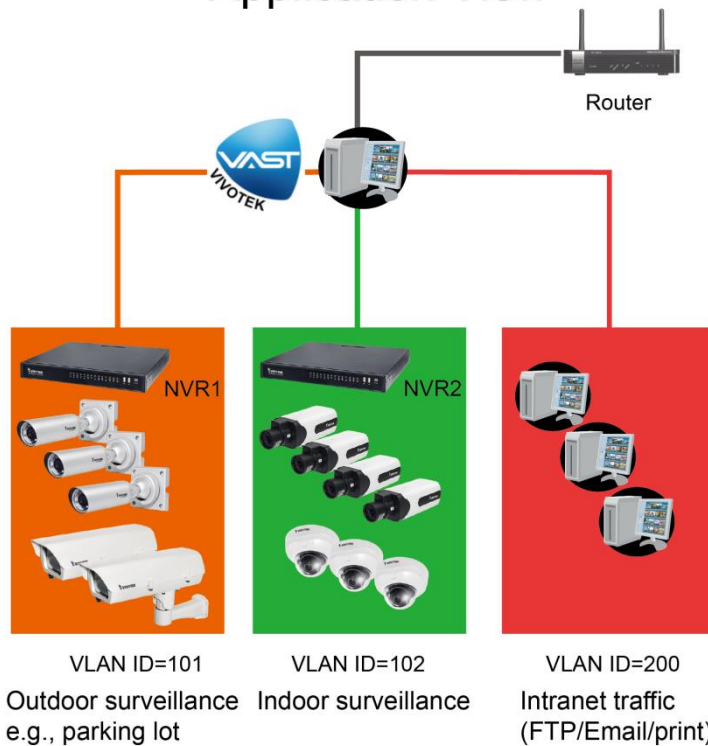

In terms of surveillance applications, the connections of an adequate number of IP cameras can be configured into a VLAN, and span across different switches. The server running the VAST central management software can join multiple VLANs, so that VAST will then be able to manage the video resources on multiple cameras and NVRs.

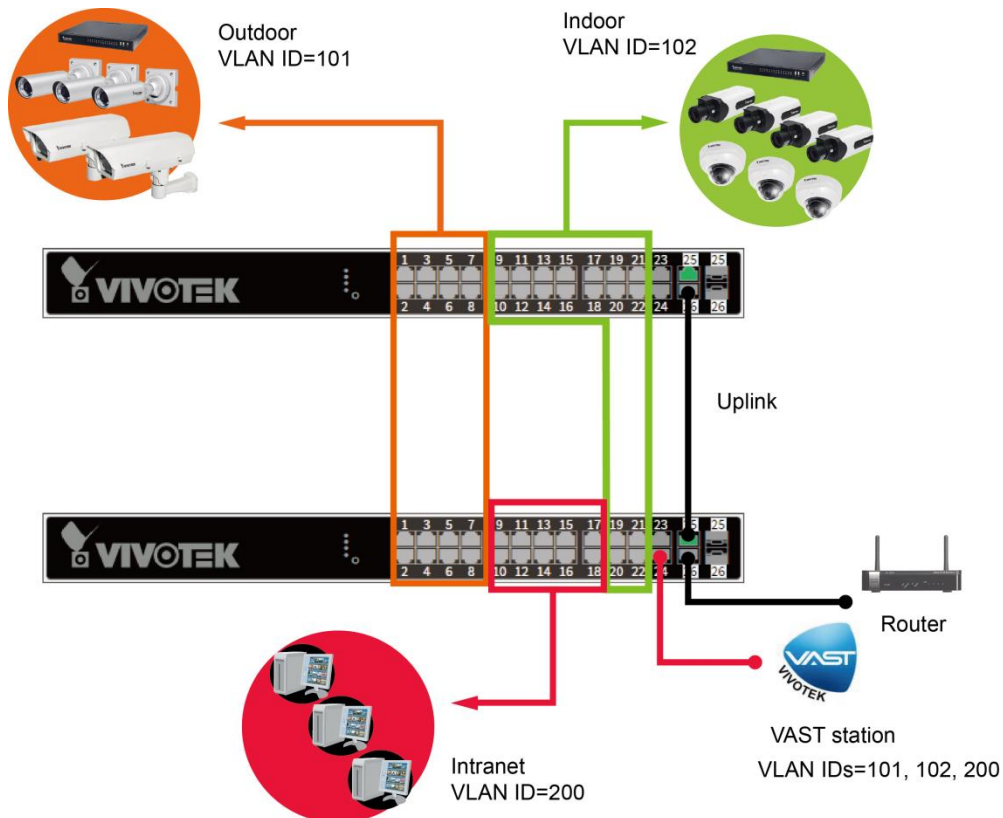

Web interface

To configure Surveillance Topology View in the web interface:

1. Click Surveillance > Graphic View > Topology View.
2. When selecting or moving to the location of a single device, click on the bubble icon  listed on the Device List panel.
3. To reveal details of a device, mouse over a device to display its device name, model name, MAC, IP, and status.
4. You can click on a device to display the quick access menu.

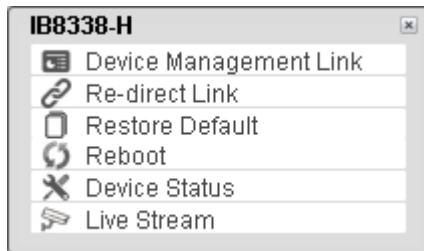

1	Opens the device Network Setting page.
2	Opens the web console with the camera.
3	Restores firmware default
4	Reboot the camera.
5	Opens the link troubleshooting page.
6	Opens a live view (stream 1). For multi-sensor models, only channel 1 video stream will be displayed.



The quick access menu is also available on the Floor View and Google Map.

The Live Stream feature applies in the following browser versions:

	Chrome V39 above	Chrome V38 under	Firefox v39	IE11	IE10	IE9	IE8
WinXP	No	Yes	Yes	--	--	--	No
Win7	No	Yes	Yes	Yes	Yes	No	No
Win8/8.1	No	Yes	Yes	Yes	YEs	No	No

You will also need to enable the QuickTime plug-ins for your browser. For example, try using the chrome://plugins command in your URL address field on Chrome.

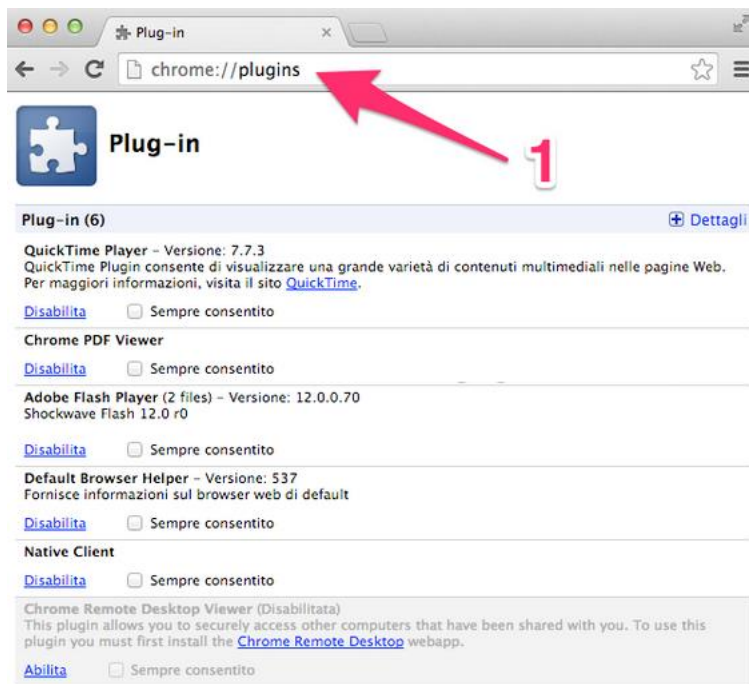

- For example, you can use the Troubleshooting function to figure out whether there is a link problem to a device. The switch sends test packets to verify the link connectivity between switch port and camera. This helps when diagnosing cabling problems in your deployments.

Another Try

Show entries

Select	Status	Model Name	Device Name
<input checked="" type="checkbox"/>	● Online	IP8152	Mega-Pixel Network Camera

Showing 1 to 4 of 4 entries

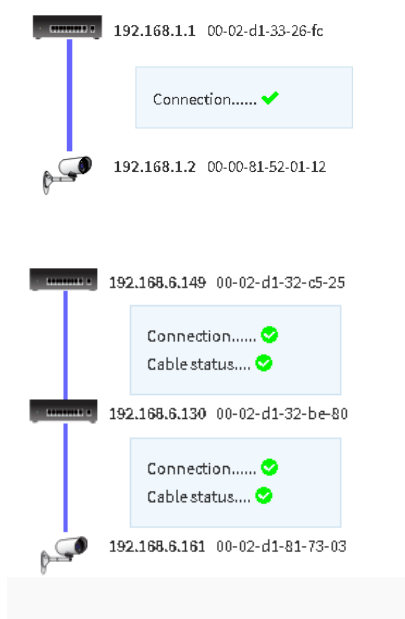
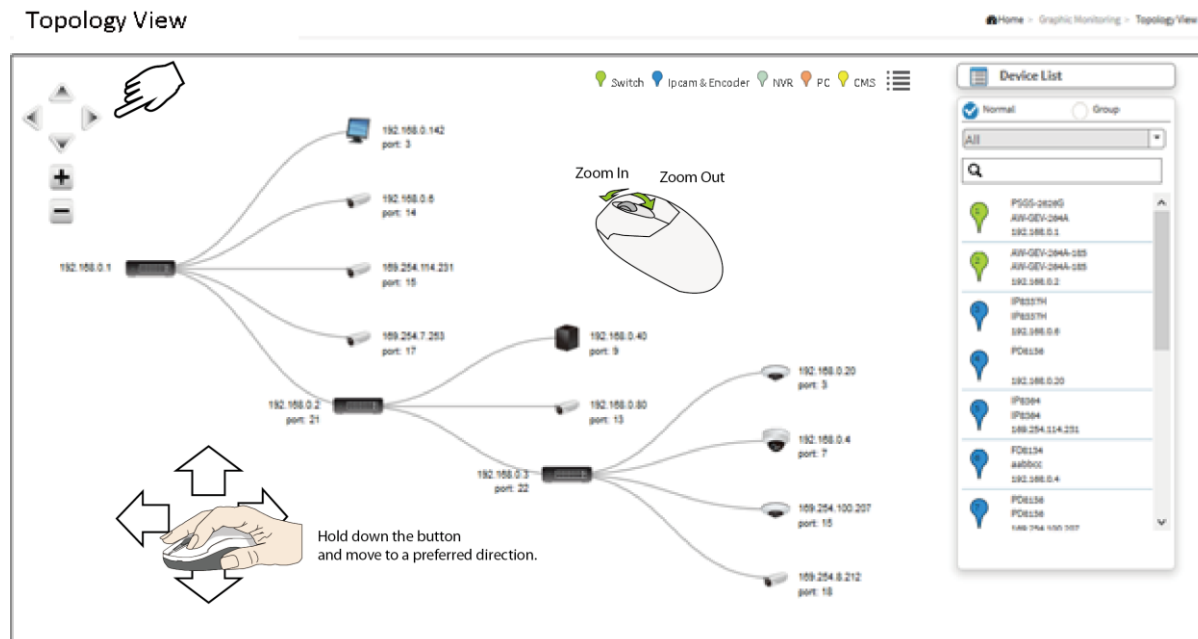

Figure 8-1.1: Topology View

See below for the sample screen and mouse control:



You can also configure VLAN grouping in the Topology View. To configure grouping, proceed with the following:

1. Enable the Grouping mode by selecting the "Group" check circle from Device List menu. Check circles will appear in front of every IP cameras. When configuring a new group, select New Group from the drop-down list. When configuring an existing group, select an existing group.
2. Select the members you prefer from the topology. Select by checking their circles.
3. Enter a Group name, Description, and a unique VLAN ID. See the previous chapter for details. VLAN ID is the VLAN identifier (VID) for the port as defined in IEEE 802.1Q-2003. A value of 1 through 4094 is used to define a valid VLAN ID. A value of 0 (Priority Tagged) is used if the device is using priority tagged frames as defined by IEEE 802.1Q-2003, meaning that only the IEEE 802.1D priority level is significant and the default PVID of the ingress port is used instead.
4. When done, click the Apply button for the configuration to take effect. Click the Save button  to save your configuration.

Figure 8-1.2: Configuring Grouping in the Topology View



A VLAN can also span across multiple switches. Select devices on multiple switches to join them into the same VLAN. They will be automatically tagged into a VLAN.

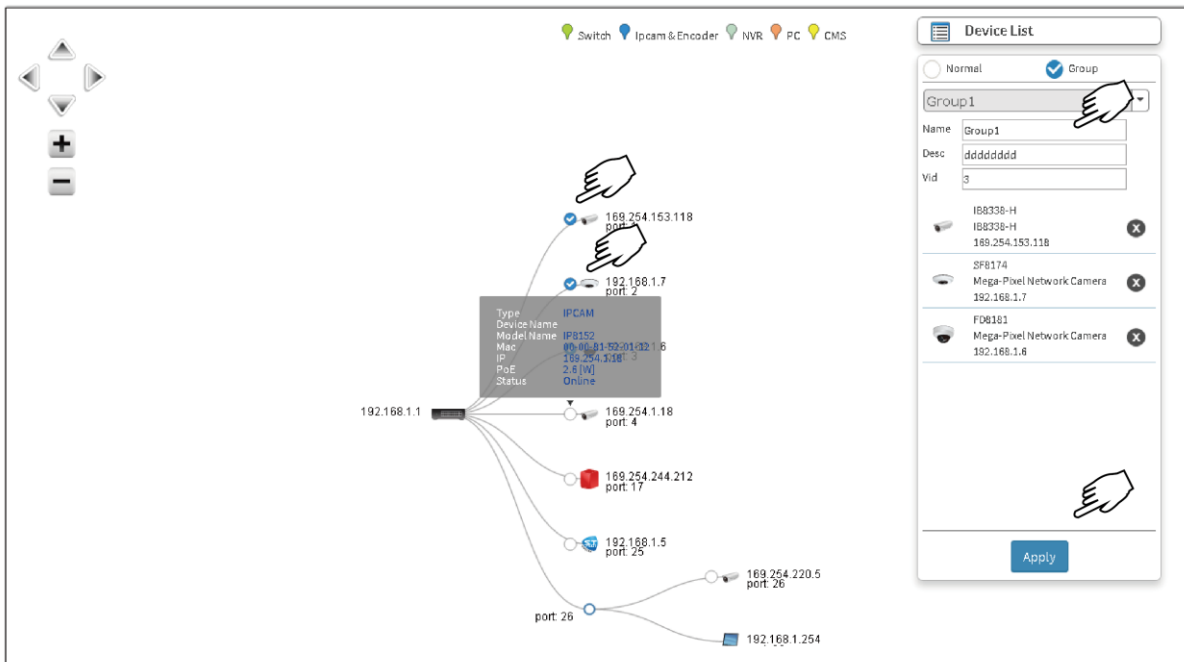
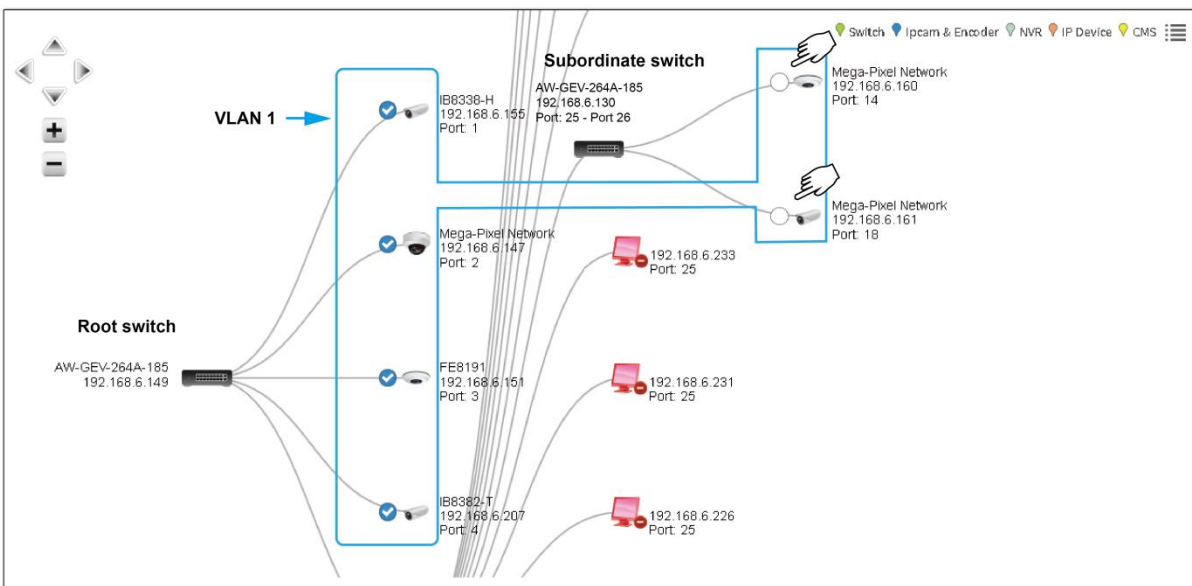

You can use the device menu to select or deselect the types of device information on screen, e.g., MAC address, or Device Name. Note that only 4 types of information can be displayed at one time.

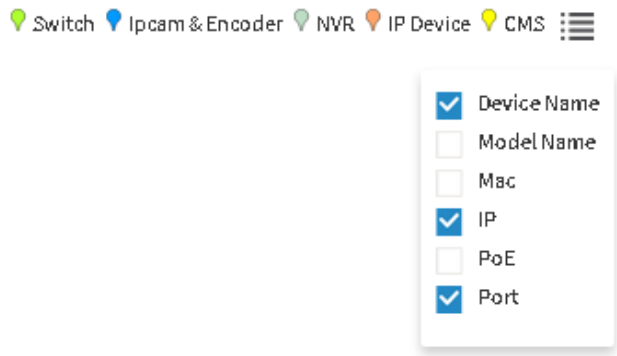

An unmanaged device is displayed with a no entry mark. The information for such device will be limited.



You can mouse over the PoE switch to quickly view the total PoE output. The same information is also shown on each network camera.

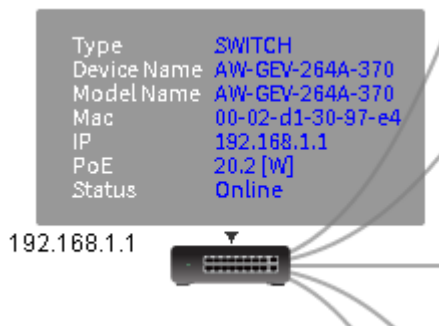

Below are statuses for the quick access menu for devices in different conditions:

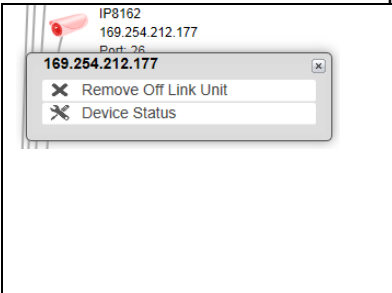
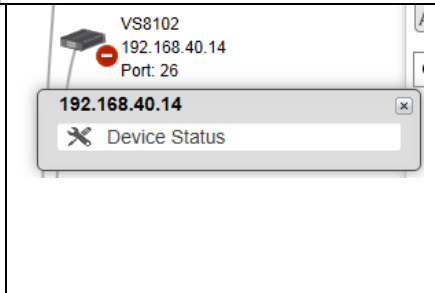
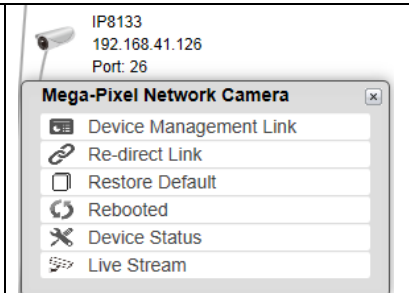
		
Offline device	Unmanaged device	Managed device

When the configuration is done, use the **Export Topology** function on the upper right of the screen to export your configuration. The file format can be SVG, PNG, or PDF.

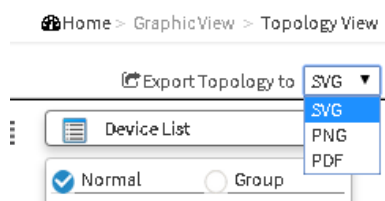

Note that if using IE browser, you can only export in the SVG format.

If you click on a surveillance switch, a PoE Config function is available that allows you to control the PoE output on all switch ports, and to enable or disable the Auto Checking function. The Auto Checking function intermittently examines the status of powered devices, and report disconnection issue when the powered device cannot be reached.

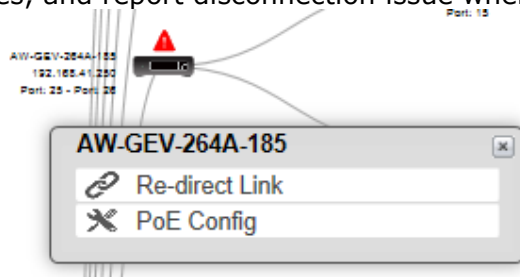

If you click on switch "+" or "-", it will retract the subtree infrastructure.

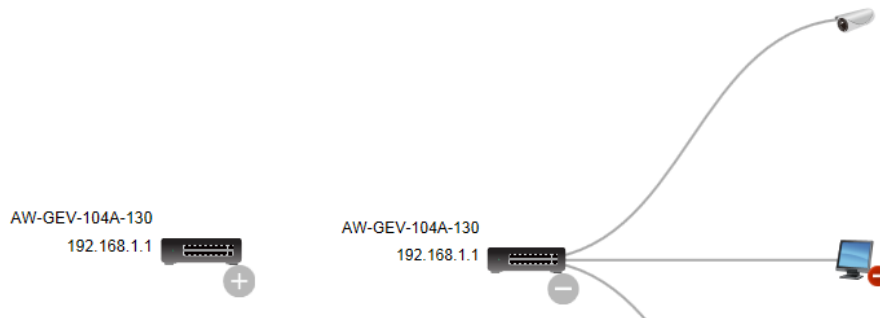

8-2 Floor View

In this page, the administrator can place a device per time onto the custom image, which you have already uploaded, by dragging-and-dropping markers in the device list.

You can upload up to 20 map files, with the limitation of 256KB in file size each.

Web interface

To configure the surveillance Floor View in the web interface:

1. Click Surveillance > Graphic View > Floor Plan > and Floor View.
2. Select a floor map you uploaded. You can prepare and upload one or multiple floor maps in the Surveillance > Floor Plan > Floor Image window.

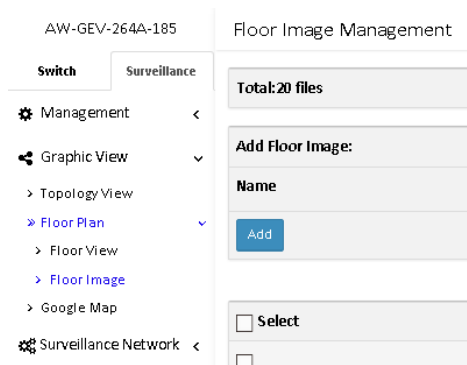

3. You then select a device on the Device List by a single click. A similar bubble icon will appear on screen. Click and drag the icon to a preferred location on the map.
4. Repeat the above process until you finish the map setup, and click the **Apply** button.
5. With multiple maps in your deployment, e.g., different floor or building, select a different floor view from the pull-down menu on top and continue with the configuration.

floor 1

floor 1

howling

howling

6. Click the Save button  to save your configuration.

Figure 8-2.1: Floor View

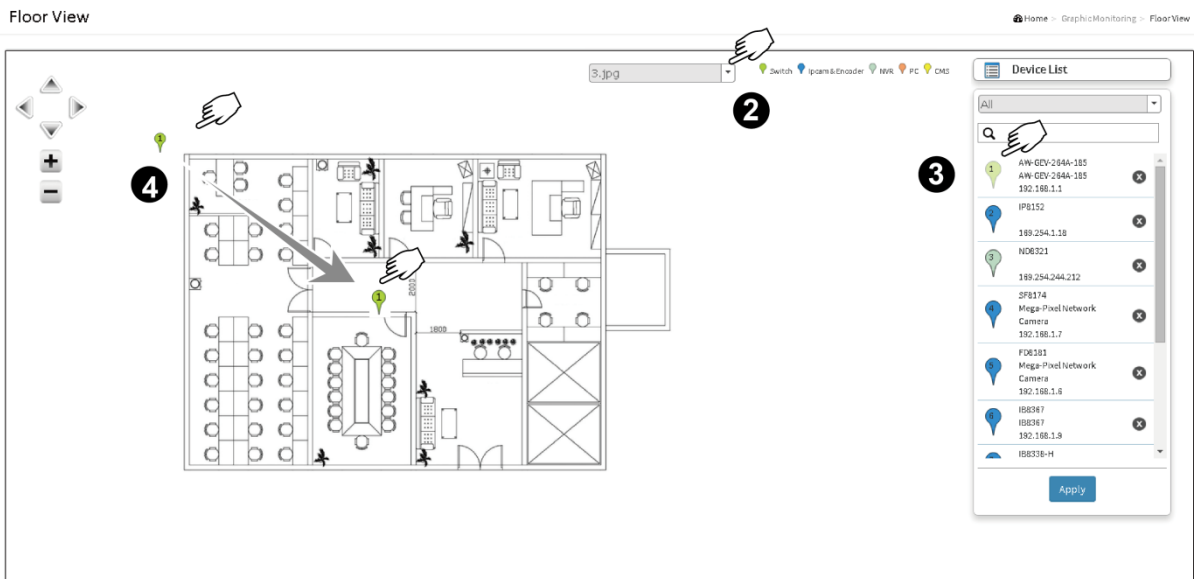

When the configuration is done, use the **Export Floor View** function on the upper right of the screen to export your configuration. The file format can be SVG, PNG, or PDF (Chrome and Firefox).

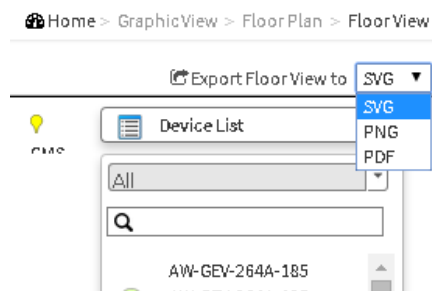

Note that if using IE browser, you can only export files in the SVG format.

8-3 Floor Image

In this page, you can upload or manage floor map images. Due to the limitation of the flash memory, up to 20 JPEG images, each of a max. of 256KB size, can be uploaded to the switch.

Web interface

To configure the Floor Image in the web interface:

1. Click Surveillance > Floor Plan > Floor Image.
2. Click “Browse...” to select Floor image from the client computer. Enter a name for the Name entry.
3. Click Add to upload. When done, a snapshot will be available on screen.
4. If you need to remove an existing floor map, select its checkbox and click Delete to remove.

Figure 8-3.1: Floor Image

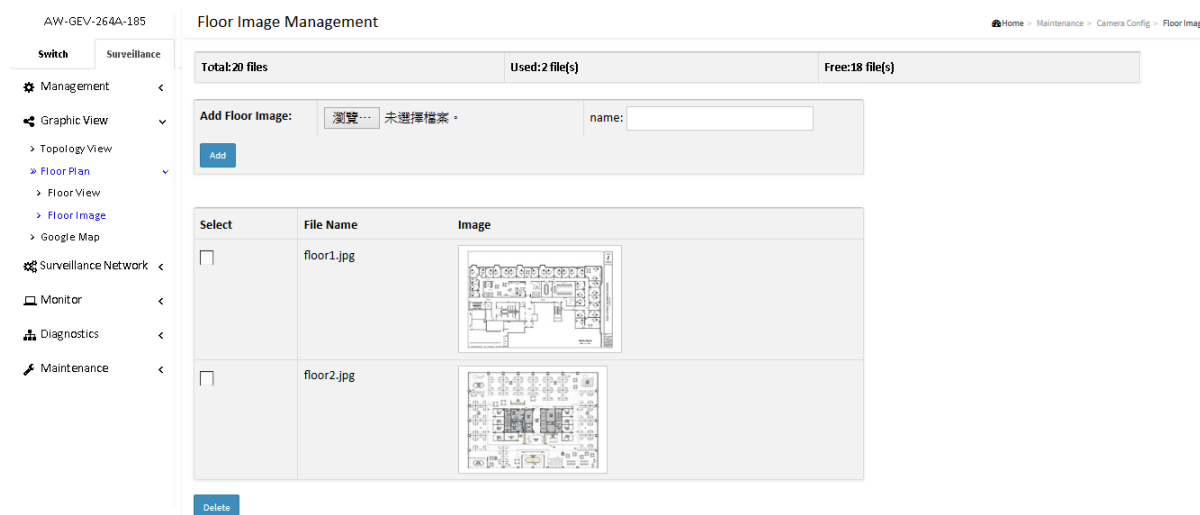

8-4 Google Map

On this page, you can view a realistic representation of devices through the Google map. This Map View applies in wide area, outdoor deployments. The preconditions for using this function are:

1. The client computer having a web session with the PoE switch must have an **Internet** connection.

Web interface

To configure Surveillance Map View in the web interface:

1. Click Surveillance > Graphic View > Google Map.
2. On the Google map, move to your location, and zoom in to a preferred view. To move on the screen, click and hold down your left mouse button to move to a preferred direction. You can also key in the address you have in mind in the Search box, e.g., Sunset Boulevard, Los Angeles, etc. The GPS location of your current position is also supported.
3. Click to select a device. The device will appear on the map.
4. Click and drag the device to a preferred location.
5. Repeat the above process to complete the map setup, and click Apply to finish the configuration.

Figure 8-4.1: Map View

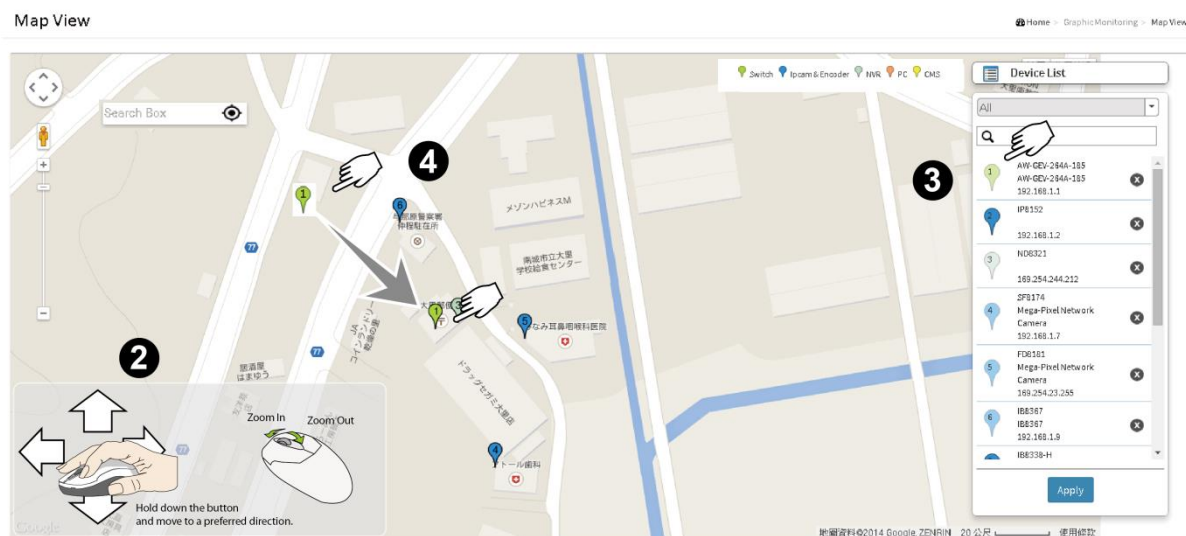

To return to a location you previously visited, simply click on a camera or device (on the Device List) you implanted on the map. The current map view will move back to the location you previously

configured. An implanted camera will be indicated by a bubble icon with a  dim out color.

To remove a camera from a Google map, click on the camera's cross mark from the Device List, and the camera will disappear from map.

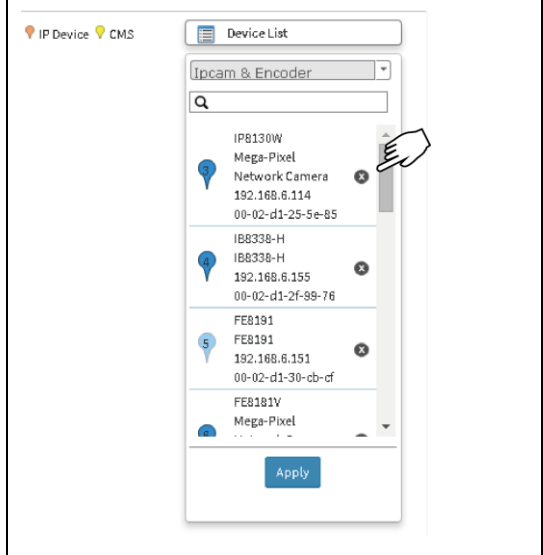

The quick access menu is also available on the Google Map.

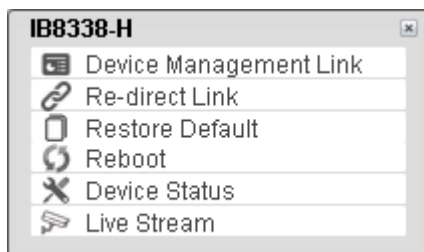

1	Opens the device Network Setting page.
2	Opens the web console with the camera.
3	Restores firmware default
4	Reboot the camera.
5	Opens the link troubleshooting page.
6	Opens a live view (stream 1). For multi-sensor models, only channel 1 video stream will be displayed.

9-1 Security

The MAC Lock function places an access control on client computers. Only the computers listed with its MAC addresses can access the PoE switch and make configuration changes. When the MAC Lock is enabled, all devices added to the switch will require that you manually add their MAC addresses to the list.

This feature is automatically synchronized to all subordinate PoE switches in the network. Configuration is necessary on the root switch only.

Web interface

To configure the Security function:

1. Click Surveillance > Surveillance Network > Security.
2. Select "Enable" in MAC Lock.
3. Specify the MAC address of the client computer or newly-added devices in the MAC add field.
4. Click Apply and Add.

Figure 9-1.1: Security

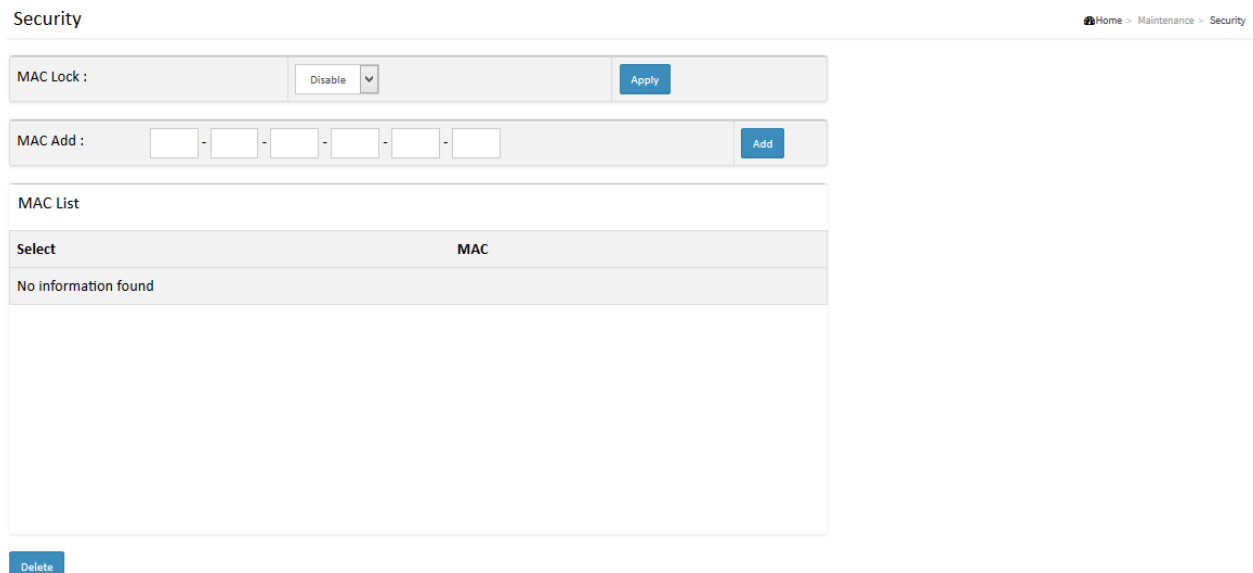

Security Home > Maintenance > Security

MAC Lock : Disable

MAC Add : - - - - -

MAC List

Select	MAC
No information found	

9-2 Grouping

Note the following with the Grouping (VLAN) configuration:

3. VLAN ID #1 is the default for all Ethernet ports on the PoE switch.
4. Enter a number ranging from 2 ~ 4095 as the VLAN ID.
5. The configuration aims to simplify the process of VLAN settings. The program will automatically configure spanning tree, loopback detection, and other associated settings in the background.

Web interface

To configure Surveillance Grouping in the web interface:



1. Click Surveillance, Management, and Grouping.
2. Click on the Add  button. Refer to the discussion below for configuration details.
3. Click the Apply button.

Figure 9-2.1: Surveillance Grouping

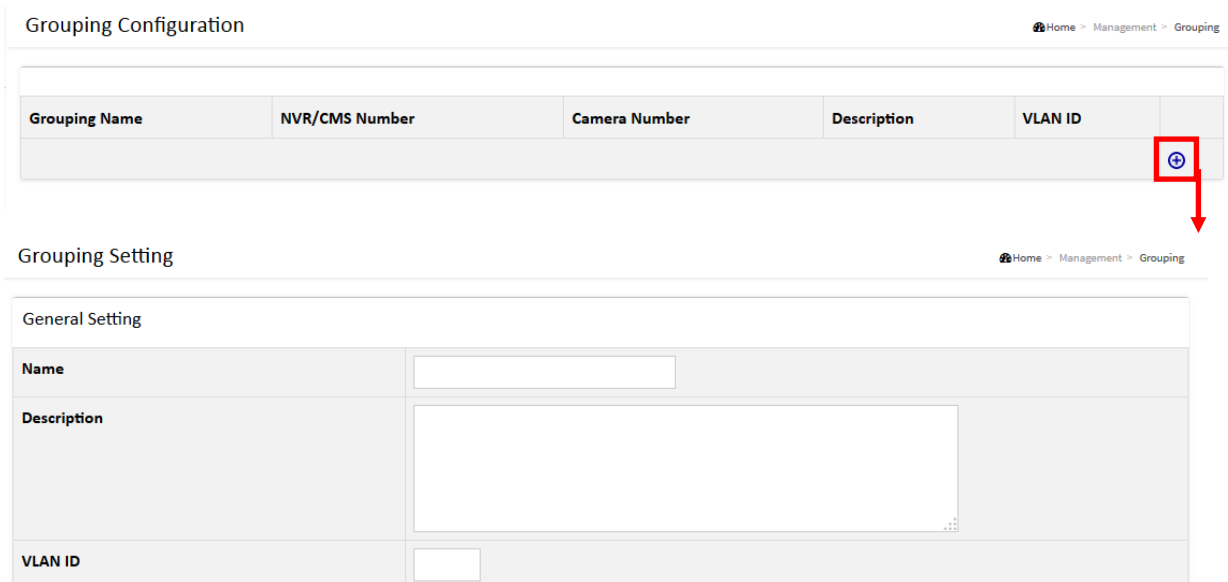

Grouping Configuration Home > Management > Grouping

Grouping Name	NVR/CMS Number	Camera Number	Description	VLAN ID	
					

Grouping Setting Home > Management > Grouping

General Setting

Name	<input type="text"/>
Description	<input type="text"/>
VLAN ID	<input type="text"/>



NVR / CMS

Member Setting	<div style="border: 1px solid #ccc; padding: 2px;">192.168.0.40</div>	<input type="button" value="Add >>"/> <input type="button" value="<< Remove"/>	<div style="border: 1px solid #ccc; height: 40px;"></div>
-----------------------	---	---	---

Camera Encoder

Member Setting	<div style="border: 1px solid #ccc; padding: 2px;"> 192.168.0.6(IP8337H) 192.168.0.20 192.168.0.5(IP8364) 192.168.0.4(aabbcc) 169.254.100.207(PD8136) 169.254.7.253(IP8362-1) 192.168.0.69(Mega-Pixel N) 192.168.0.80(Mega-Pixel N) </div>	<input type="button" value="Add >>"/> <input type="button" value="<< Remove"/>	<div style="border: 1px solid #ccc; height: 40px;"></div>
-----------------------	---	---	---

Parameter description:

- **Grouping Name:**
Enter a name for a VLAN group (1~32 numeric or alphabetic characters).
- **Description:**
Enter a short description for the VLAN group (0~255 numeric or alphabetic characters).
- **VLAN ID:**
Enter a number ranging from 2 to 4095 as the VLAN ID.
- **Member Setting:**
Single-click to select an NVR/CMS device or camera from the device list. You can also use the combination of Shift key and mouse clicks to select multiple devices. Click the Add button to move them to the column on the right. When done, click the Apply button at the bottom of the screen.
- **Modification Buttons :**
 -  : Add a new entry.
 -  : Edit an existing entry.
 -  : Delete an existing entry.

10-1 Traffic Chart

This page displays a visual chart of network traffic of all the devices managed by the PoE switch. Numbers are shown in Mbit/s. The switch can keep the traffic chart records for up to two weeks.

Web interface

To view the traffic through all the switch ports or a specific port:

1. Click Surveillance > Monitor > and Traffic Chart.
2. Click on specific port on the traffic chart to reveal its traffic during the day. You can select to display a summary of a week's traffic by selecting the check circle on top. The same applies to the selection of Rx Tx traffic. A single port's traffic is shown at the lower half of the screen.
3. To select to display the throughput of a single camera, mouse over to display its information, and then single-click to display.

Figure 10-1.1: Traffic Monitor



10-2 Instant Throughput

This page displays a visual chart of network traffic of all the devices managed by the PoE switch. Numbers are shown in Mbit/s.

Web interface

To view the throughput through a specific port:

1. Click Surveillance > Monitor > and Instant Throughput.
2. Click on a specific device on the device list to reveal its instant throughput. Wait for a few seconds until the throughput numbers are displayed as a line chart. A single port's traffic throughput is shown on the screen.

Figure 10-1.2: Instant Throughput

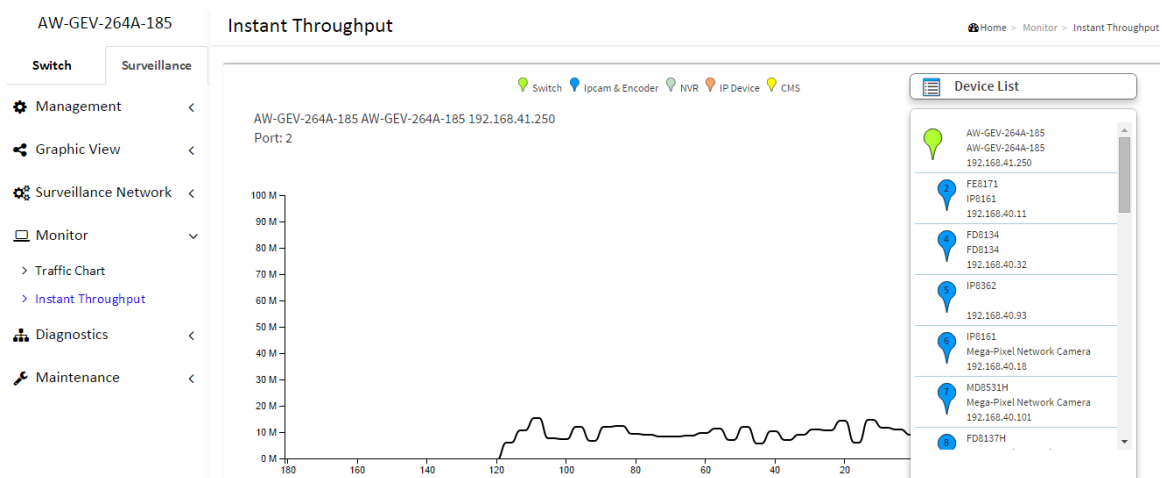

11-1 Device Status

In this page, you can troubleshoot the connection between PoE switch and IP Devices. This feature is designed primarily for administrators to verify and test the link routes between the switch and the IP device. Note that the topology of network needs to be saved for this function to work properly.

Web interface

To configure Surveillance Information in the web interface:

1. Click Surveillance > Diagnostics > and Device Status.
2. Select a device's checkbox and click the Start button to start the connectivity test.
3. Click Another Try to go back to the Device Status screen.

Figure 11-1.1: Device Status

Device Status Home > Diagnostics > Device Status

Start from MAC address with entries per page.

	Status	Model Name	Device Name	MAC	IP Address	Version
<input type="checkbox"/>	● Online	IP8337H	IP8337H	00-02-d1-27-b2-98	192.168.0.6	0101a
<input type="checkbox"/>	● Online	PD8136		00-02-d1-28-66-92	192.168.0.20	0200b
<input type="checkbox"/>	● Online	IP8364	IP8364	00-02-d1-28-72-e7	192.168.0.5	0101a
<input type="checkbox"/>	● Online	FD8134	aabbcc	00-02-d1-28-c9-ab	192.168.0.4	0301c
<input type="checkbox"/>	● Online	PD8136	PD8136	00-02-d1-29-64-cf	169.254.100.207	0101b
<input type="checkbox"/>	● Online	IP8362	IP8362-1	00-02-d1-2d-07-fd	169.254.7.253	0200d
<input type="checkbox"/>	● Online	IP8362	Mega-Pixel Network Camera	00-02-d1-2d-08-d4	192.168.0.69	0200d
<input type="checkbox"/>	● Online	IP8335H	Mega-Pixel Network Camera	00-02-d1-2d-f0-f6	192.168.0.80	0204c

12-1 Device info to CSV

You can export the PoE switch's device information as a CSV file to a client computer. The CSV file will be exported to the client computer currently having a web session with the switch.

Web interface

To export switch device information to a client computer:

1. Click Surveillance > Maintenance > and Device info to CSV.
2. Click Export

Figure 12-1.1: Device info to CSV

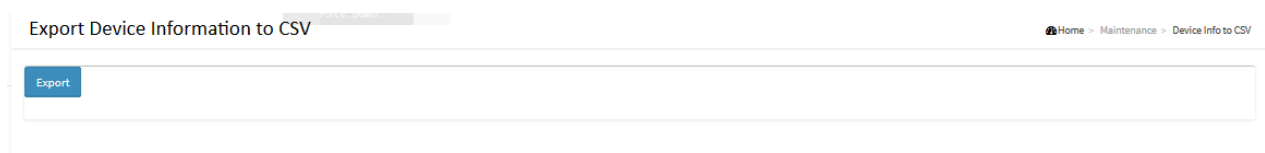

12-2 Surveillance Config

You can save or clear surveillance configuration on this page.

Web interface

To save or clear surveillance configuration:

1. Click Surveillance > Maintenance > and Surveillance Config.
2. Click Save Configuration to save your current settings. You may also use the Clear Configuration function to remove all existing configurations, such as floor map or VLAN grouping. The Factory Defaults button can be used to restore all switch configurations to factory defaults.

Figure 12-2.1: Surveillance Config

