

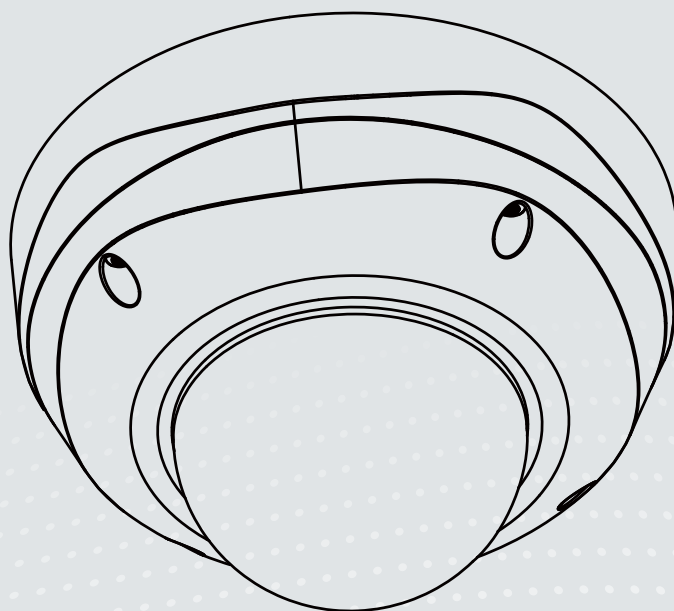

**FD8335H** Fixed Dome  
Network Camera

# User's Manual

720P HD • P-Iris • WDR Pro  
IP66 Vandal-proof



Rev. 1.1

## ***Table of Contents***

---

<b>Overview</b> .....	<b>4</b>
Revision History .....	4
Read Before Use .....	5
Package Contents .....	5
Symbols and Statements in this Document .....	5
Physical Description .....	6
Installation .....	9
Network Deployment .....	15
Software Installation .....	18
Ready to Use .....	19
Completion .....	20
<b>Accessing the Network Camera</b> .....	<b>21</b>
Using Web Browsers .....	21
Using RTSP Players .....	24
Using 3GPP-compatible Mobile Devices .....	25
Using VIVOTEK Recording Software .....	26
<b>Main Page</b> .....	<b>27</b>
<b>Client Settings</b> .....	<b>32</b>
<b>Configuration</b> .....	<b>34</b>
System > General settings .....	35
System > Homepage layout .....	37
System > Logs .....	40
System > Parameters .....	41
System > Maintenance .....	42
Security > User Account .....	46
Security > HTTPS (Hypertext Transfer Protocol over SSL) .....	47
Security > Access List .....	52
Network > General settings .....	57
Network > Streaming protocols .....	65
Network > SNMP (Simple Network Management Protocol) .....	74
Media > Image .....	75
Media > Video .....	82
Media > Video .....	83
Media > Audio .....	87
PTZ > PTZ settings .....	88
Event > Event settings .....	92
Applications > Motion detection .....	105
Applications > DI and DO .....	108
Applications > Tampering detection .....	108
Recording > Recording settings .....	109
Local storage > SD card management .....	114
Local storage > Content management .....	115
<b>Appendix</b> .....	<b>118</b>
URL Commands for the Network Camera .....	118

Technical Specifications ..... 195  
 Technology License Notice..... 196  
 Electromagnetic Compatibility (EMC)..... 197

 **NOTE:**

1. Remove the foam pads on top of camera lens and IR LEDs when you install the Fixed Dome camera. These foam pads protect delicate components during the shipping process.

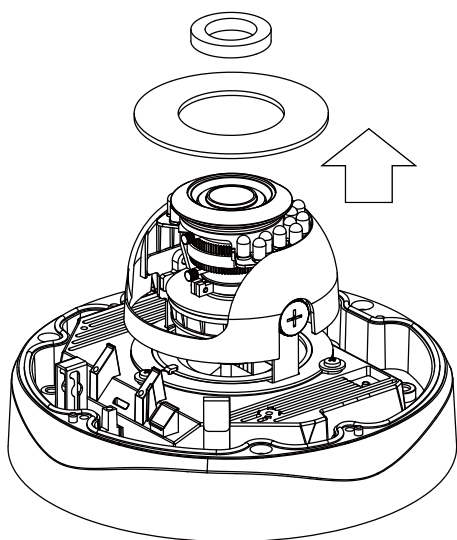

2. Under no circumstances should you remove the rubber lens hood on the lens module. The lens hood blocks out lights emitting from the IR LEDs. If it is gone, reflections bounced back from the dome cover will seriously affect image quality.

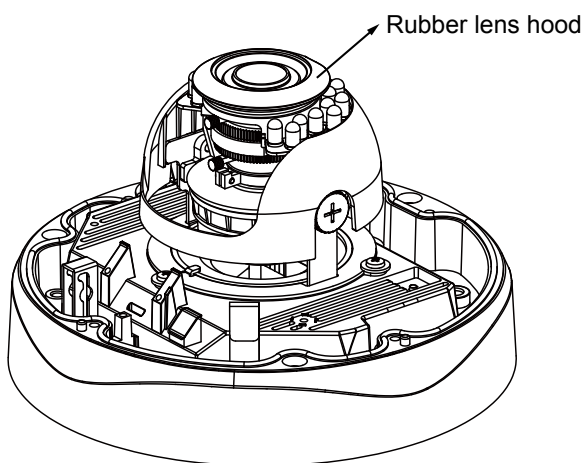

# Overview

VIVOTEK's FD8335H network camera features an HD WDR CMOS sensor to cope with challenging lighting conditions. The WDR feature allows the camera to capture both the dark and bright parts of an image and combines the differences to generate a highly realistic image representative of the original scene, enabling it to provide video quality close to the capabilities of the human eye. This function enables the FD8335H to be widely applicable in high contrast environments such as lobby entrances, parking lots, ATMs, loading areas, and much more. The P-iris lens controls the iris with extreme precision; with its built-in stepper motor, it maintains the iris opening at an optimal level at all times, resulting in superior image clarity and depth of field as well as image quality.

Incorporating an IR-cut filter that can be removed automatically at night and built-in IR illuminators with coverage of up to 20 meters, the FD8335H is an outstanding 24-hour surveillance solution. The vandal-proof and the IP66-rated housing of the FD8335H enables users to easily build a cost-effective IP surveillance system without additional accessories. Its metal vandal-proof housing effectively provides robust protection from vandalism. Meanwhile, the IP66 integrated housing shields the camera from dust and water, allowing it to be applied in the harsh weather conditions of outdoor environments.

## Revision History

- Rev. 1.0: Initial release
- Rev. 1.1: Corrected DO pin description.

## Read Before Use

The use of surveillance devices may be prohibited by law in your country. The Network Camera is not only a high-performance web-ready camera but can also be part of a flexible surveillance system. It is the user's responsibility to ensure that the operation of such devices is legal before installing this unit for its intended use.

It is important to first verify that all contents received are complete according to the Package Contents listed below. Take note of the warnings in the Quick Installation Guide before the Network Camera is installed; then carefully read and follow the instructions in the Installation chapter to avoid damage due to faulty assembly and installation. This also ensures the product is used properly as intended.

The Network Camera is a network device and its use should be straightforward for those who have basic networking knowledge. It is designed for various applications including video sharing, general security/surveillance, etc. The Configuration chapter suggests ways to best utilize the Network Camera and ensure proper operations. For creative and professional developers, the URL Commands of the Network Camera section serves as a helpful reference to customizing existing homepages or integrating with the current web server.

## Package Contents

- FD8335H
- Mounting Plate
- Alignment sticker/Ceiling Hole Template Sticker
- L-type Hex key wrench / Moisture absorber / Screws / Hex Nut / Double-side tape / AV cable
- Software CD
- Warranty Card
- Quick Installation Guide
- Waterproof Connector & bushing

## Symbols and Statements in this Document



**INFORMATION:** provides important messages or advices that might help prevent inconvenient or problem situations.



**NOTE:** Notices provide guidance or advices that are related to the functional integrity of the machine.



**Tips:** Tips are useful information that helps enhance or facilitate an installation, function, or process.



**WARNING! or IMPORTANT!:** These statements indicate situations that can be dangerous or hazardous to the machine or you.



**Electrical Hazard:** This statement appears when high voltage electrical hazards might occur to an operator.

# Physical Description

## Inner View

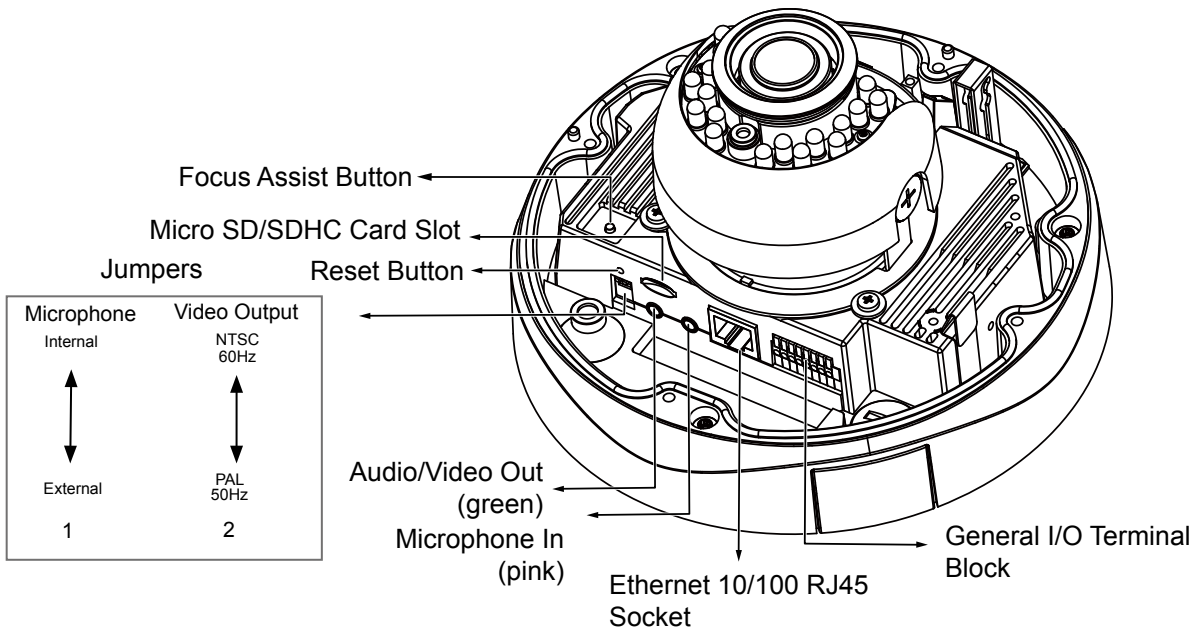
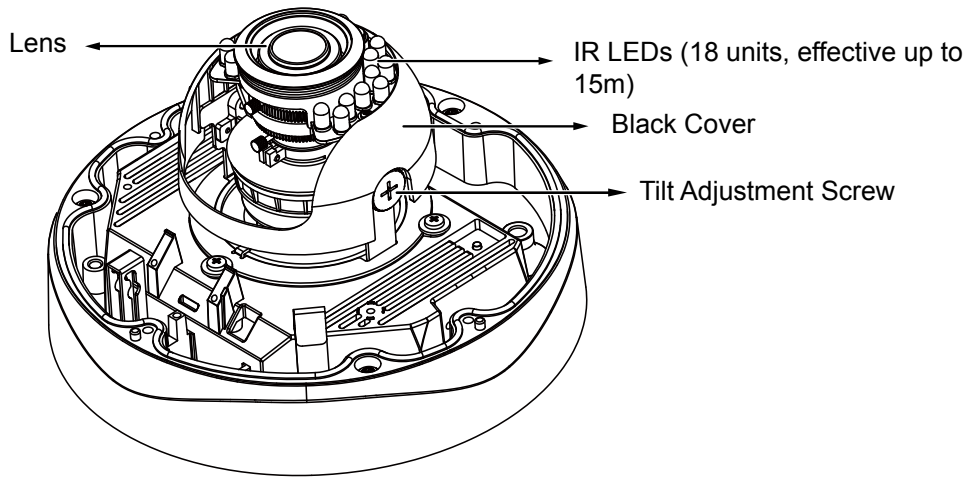

## General I/O Terminal Block

This Network Camera provides a general I/O terminal block which is used to connect external input / output devices. The pin definitions are described below. The 24V AC can be used as an alternate power source.

1	AC24V_2
2	AC24V_1
3	DI3+
4	DI2+
5	DI1+
6	DI-
7	DO-
8	DO+ (12V)

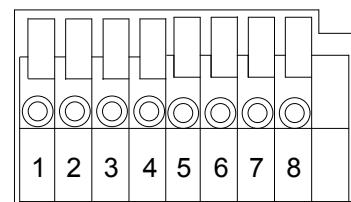

## DI/DO Diagram

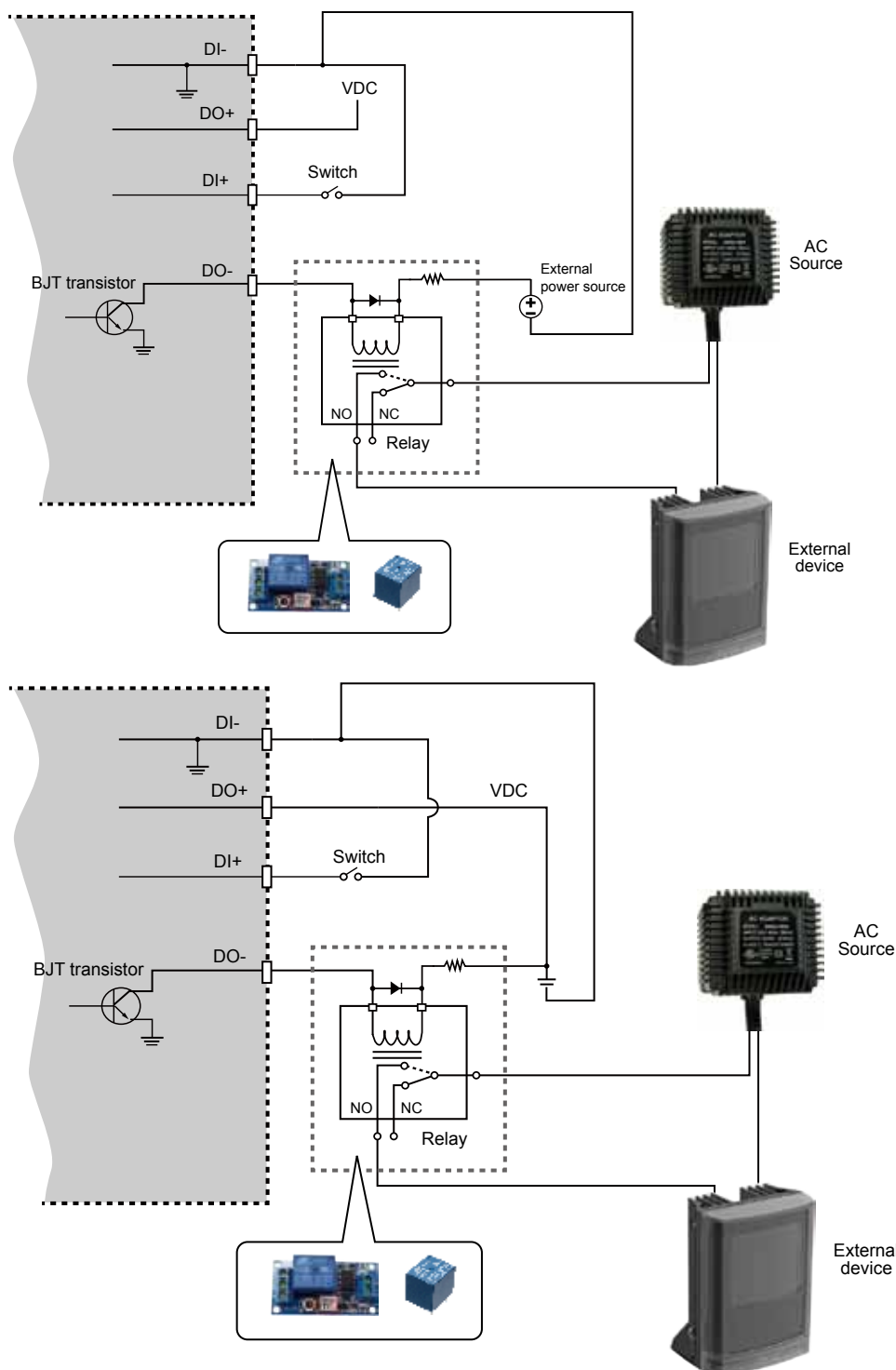

1. The DO+ pin provides different output voltages depending on the camera model (12V, 5V, 3.3V), and the max. load is 50mA.
2. The max. voltage for DO- pins is 80VDC (External power).  
In order to control AC devices, the above diagram can be taken in consideration. The diagram uses a relay to control the ON/OFF condition of the AC device.
3. An external relay can be triggered by using DO+ or by an external power source, depending on the type of relay you use.
4. In case of using an individual relay (instead of using a relay module), for protection against voltage or current spikes, a transient voltage suppression diode must be connected in parallel with the inductive load.

## Hardware Reset

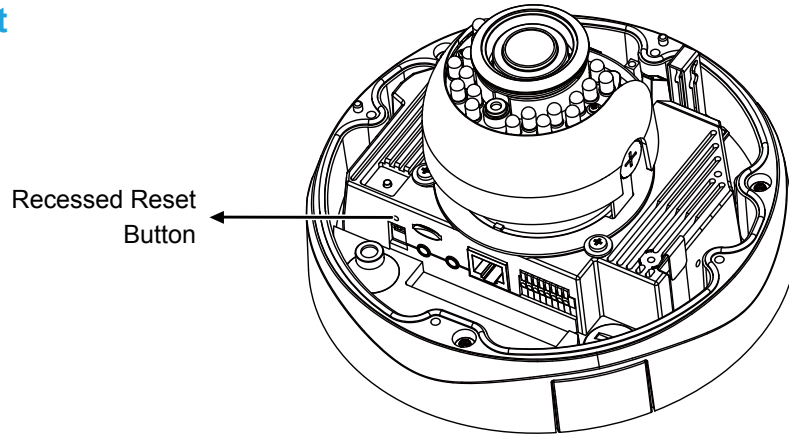

The reset button is used to reset the system or restore the factory default settings. Sometimes resetting the system can return the camera to normal operation. If the system problems remain after reset, restore the factory settings and install again.

**Reset:** Press and release the recessed reset button with a straightened paper clip. Wait for the Network Camera to reboot.

**Restore:** Press and hold the recessed reset button until the status LED rapidly blinks. Note that all settings will be restored to factory default. Upon successful restore, the status LED will blink green and red during normal operation.

## Micro SD/SDHC Card Capacity

This network camera is compliant with **Micro SD/SDHC 16GB / 8GB** and other preceding standard SD cards.



## Installation

### Removing Dome Cover

First, use the included T20 hex key wrench to loose the four screws and detach the dome cover from the camera base. Follow the steps below to install the camera either to a ceiling or a wall.



#### IMPORTANT!

The dome cover should be removed first because if it should fall during the installation process, physical injury could occur to your co-workers.

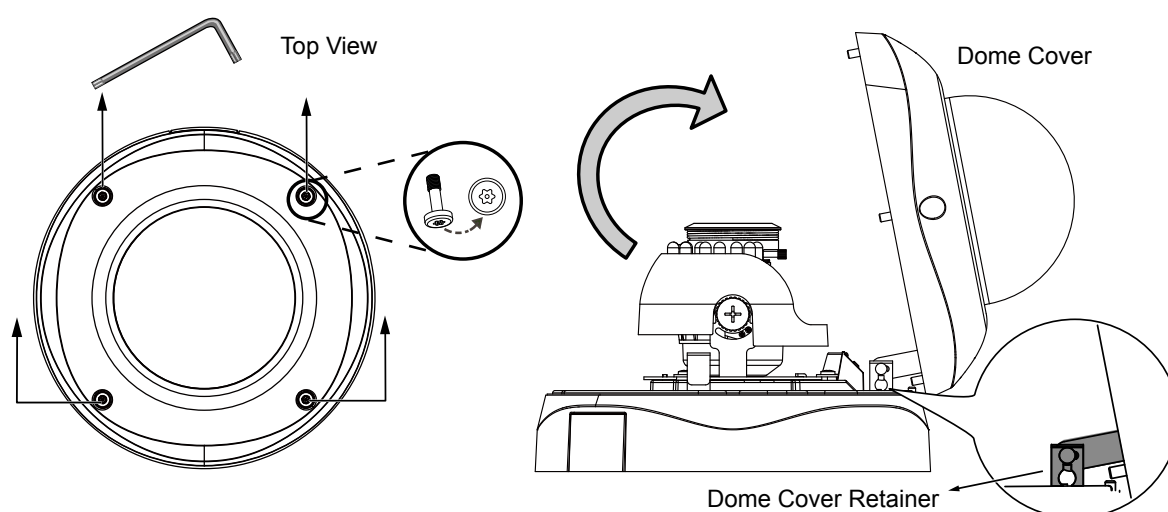

### Cabling Assembly

Connect power lines and if you have external devices such as sensors and alarms, make the connection from the general I/O terminal block.

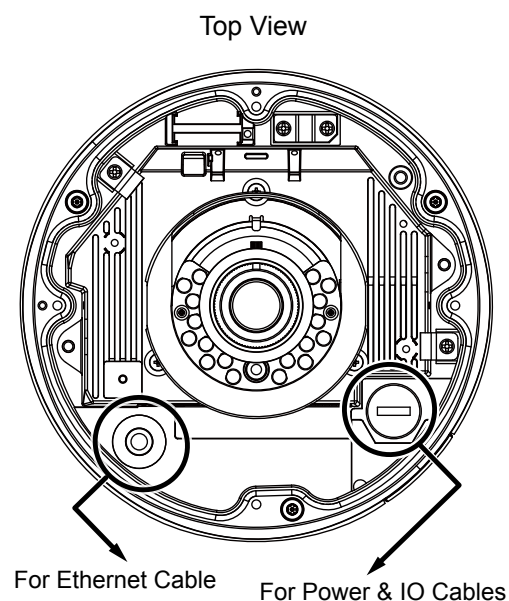

Power and IO cables pass through a waterproof connector. The Ethernet cable should be routed through a rubber seal plug. All cables are user-supplied.

## Waterproof Connector

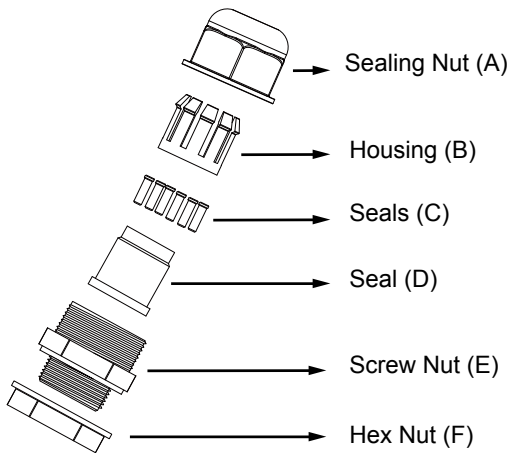

### ● Assembling Steps

1. Disassemble the components of the waterproof connector into parts (A) ~ (F) as shown above.
2. Place the screw nut (E) on the Power and GPIO opening.
3. Feed the power cables through the waterproof connector (F --> E --> D --> B --> A) as the illustration shows. Then connect the power cables to the power source. Note: There are 8 holes on the seal (D), and the widest holes with a crack on the side are specific for power cables.
4. If you have external devices such as sensors and alarms, feed the cables through the waterproof connector (F --> E --> D --> B --> A) as previously described.

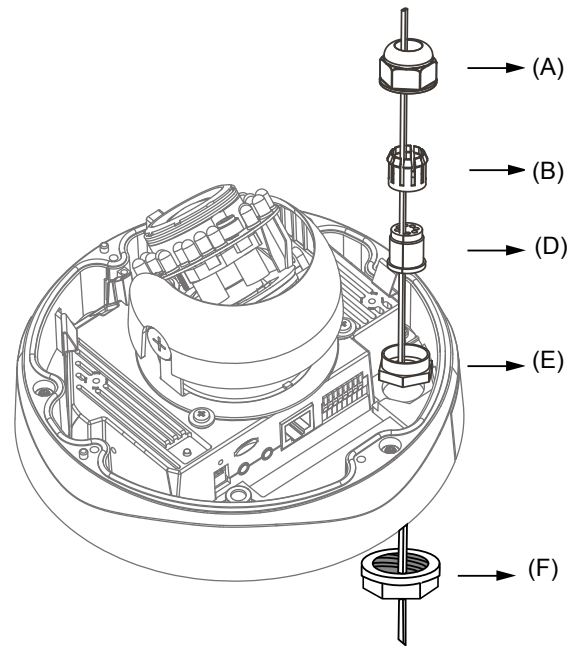

Refer to the pin definition to connect them to the general I/O terminal block. Note: The recommended cable gauge is 2.0 ~ 2.8 mm.

5. Push the seal (D) into the housing (B).
6. Insert the seals (C) into unused holes on the seal (D) to avoid moisture.
7. Secure the sealing nut (A) tightly and hex nut (F) from the bottom of the camera.

## Connecting RJ45 Ethernet Cable

### ● RJ45 Cable Dimension (unit: mm)

Recommended cable gauge: 24AWG (0.51 mm)

### ● Assembling Steps

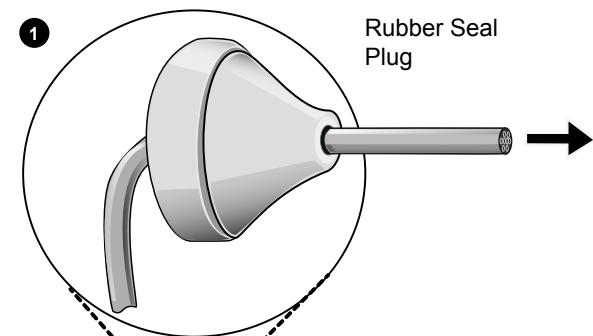

1. Drill a hole on the rubber seal plug and insert an Ethernet cable through the opening.

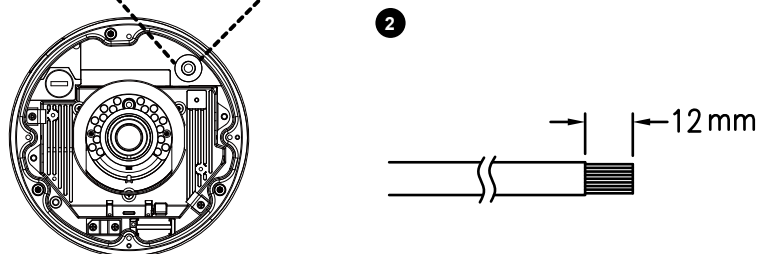

2. Strip part of the sheath from the Ethernet cable.

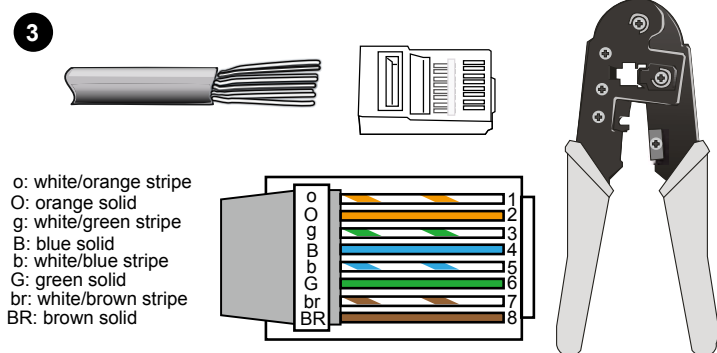

3. You will need an RJ45 crimping tool to attach the Ethernet wires to a connector. When done, connect the cable to the camera's Ethernet RJ45 socket.

4. Press the Ethernet cable into the routing path at the bottom of the camera so that the cable will not get in the way when the metal mounting plate is attached.

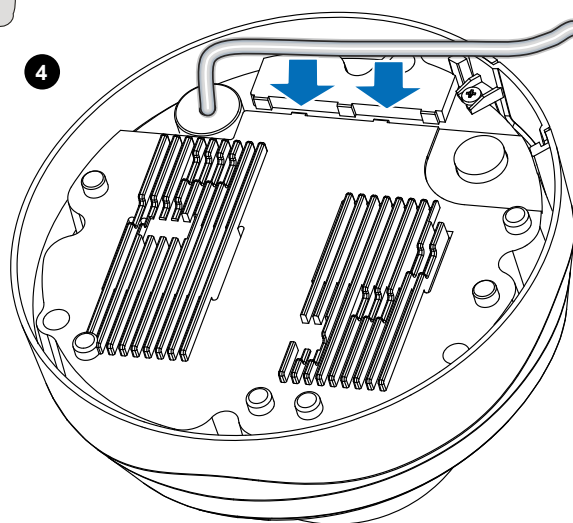

**⚠ IMPORTANT!**

Record the MAC address under the camera base before installing the camera.

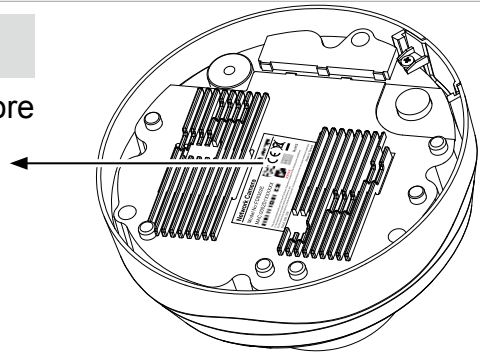
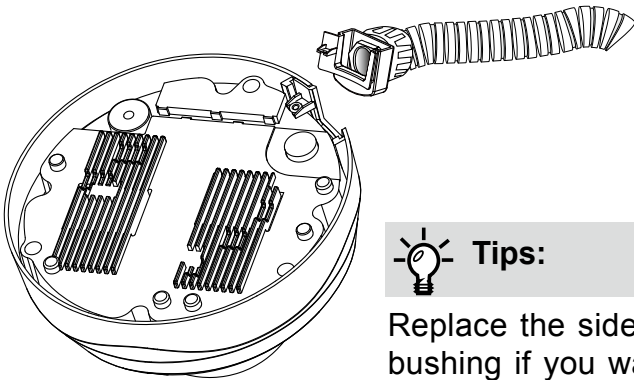

**💡 Tips:**

Replace the side opening cover with the included side outlet bushing if you want to route cables from the side of camera. The 1/2" protection conduits and tubing, if applied, are separately purchased.

**💡 Tips:**

The **Focus Assist** button takes effect when using a hand-held monitor or camera tester with a BNC connector. Press the button and use the Focus and Zoom adjustment pullers (see page 20) to tune the image until the "BEST FOCUS" message is shown. This function helps installers to quickly tune zoom and focus especially when the camera is in a position that is difficult to reach.



LCD Monitor/  
Camera tester

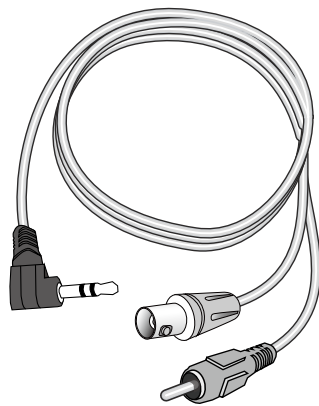

Focus Assist  
Button

AV Out

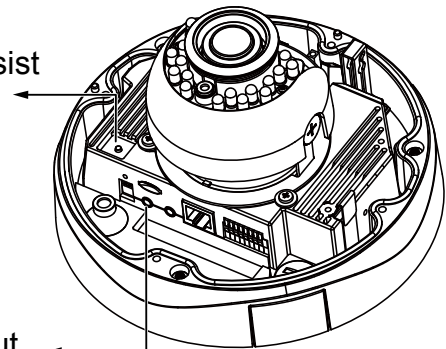

## Wall mount

1. Attach the supplied alignment sticker to the wall.
2. Using the circle marks on the sticker, drill at least 2 pilot holes symmetrically on each side into the wall. Then hammer the four supplied plastic anchors into the holes.
3. Through three or four holes on the mounting plate, insert the supplied screws into the corresponding holes and secure the mounting plate with a screwdriver.
4. Feed the cables through the triangular cutout A or side opening B. If you want to use hole B, remove the side cover using a screwdriver. Secure the camera base to the mounting plate with three supplied screws.
5. Remove the black cover.

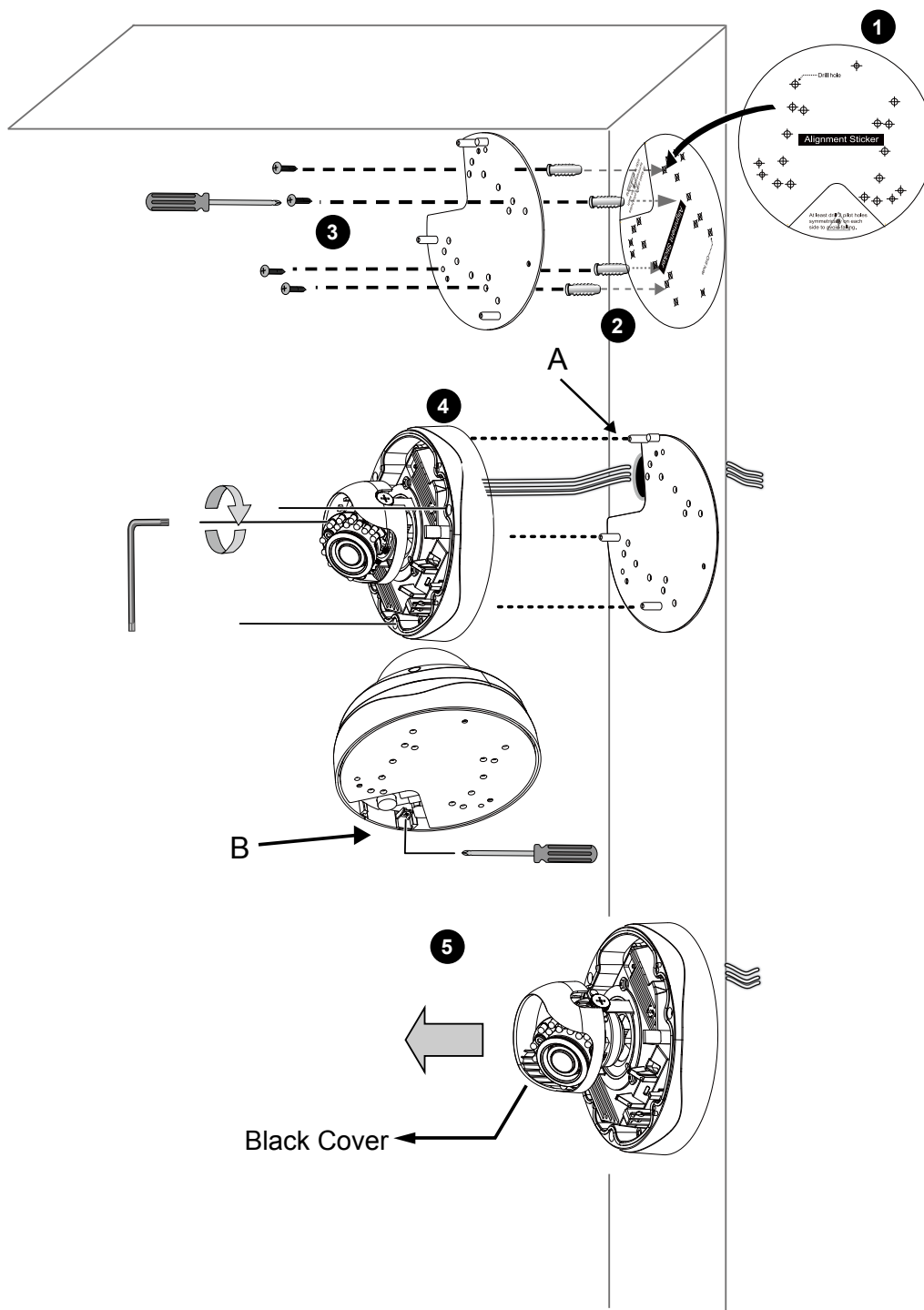

## Ceiling mount

1. Attach the supplied alignment sticker to the ceiling.
2. Using the circle marks on the sticker, drill at least 2 pilot holes symmetrically on each side into the ceiling. Then hammer the four supplied plastic anchors into the holes.
3. Through three or four holes on the mounting plate, insert the supplied screws into the corresponding holes and secure the mounting plate with a screwdriver.
4. Feed the cables through the triangular cutout A or side opening B. If you want to use hole B, remove the side cover using a screwdriver. Secure the camera base to the mounting plate with three supplied screws.
5. Remove the black cover.

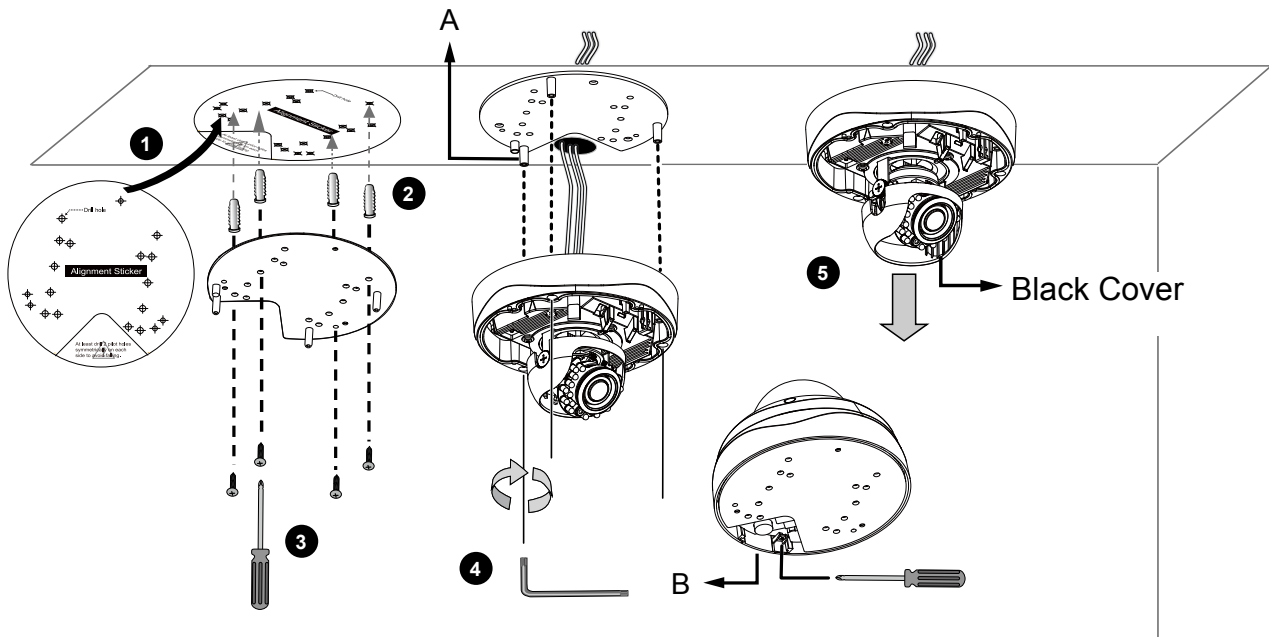

## Network Deployment

### General Connection (without PoE)

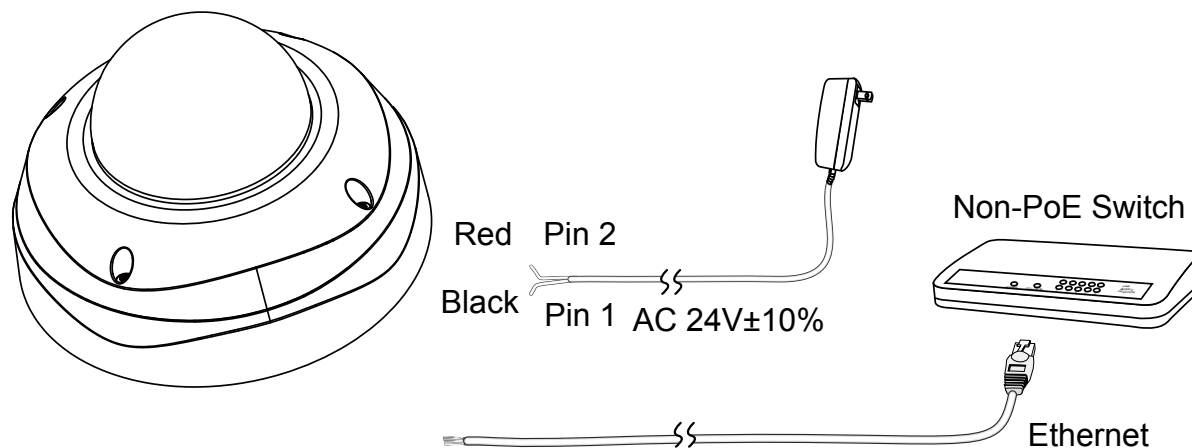

1. Connect RJ45 Ethernet cable to a switch. Use a Category 5 Cross Cable when your network camera is directly connected to PC.

2. Connect the AC cables from the terminal block as an alternate power source. The IO cables are user-supplied.

### Power over Ethernet (PoE)

#### ● When using a PoE-enabled switch

The Network Camera is PoE-compliant, allowing transmission of power and data via a single Ethernet cable. Follow the below illustration to connect the Network Camera to a PoE-enabled switch via Ethernet cable.

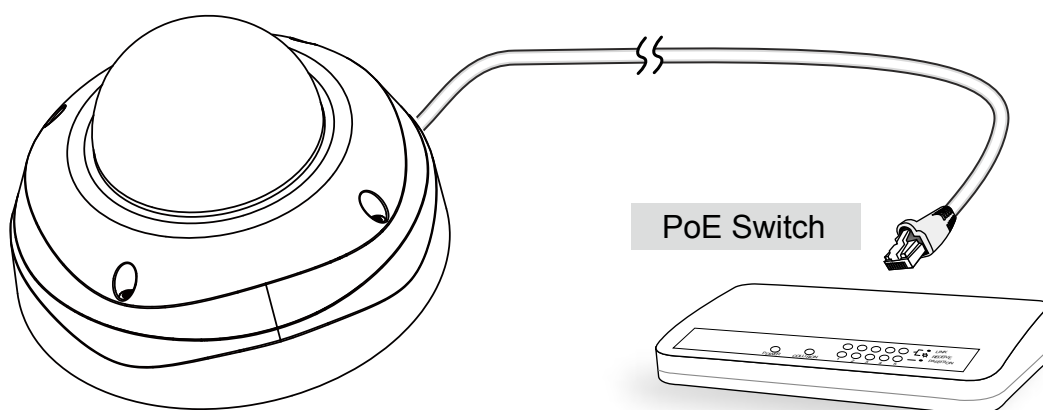

● **When using a non-PoE switch**

Use a PoE power injector (optional) to connect between the Network Camera and a non-PoE switch.

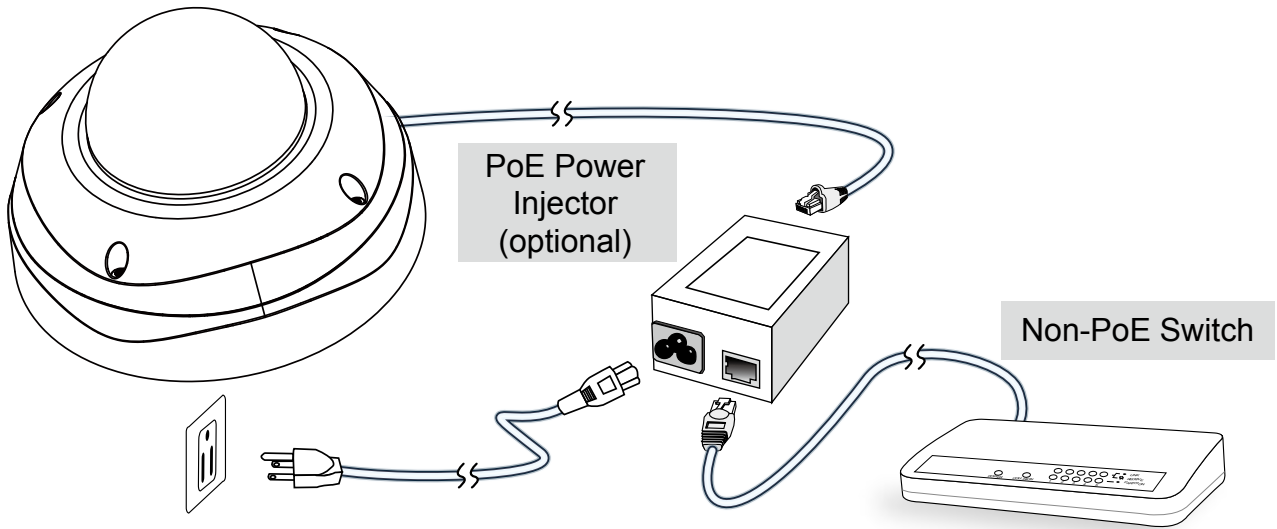



## Internet connection via a router

Before setting up the Network Camera over the Internet, make sure you have a router and follow the steps below.

1. Connect your Network Camera behind a router, the Internet environment is illustrated below. Regarding how to obtain your IP address, please refer to Software Installation on page 18 for details.

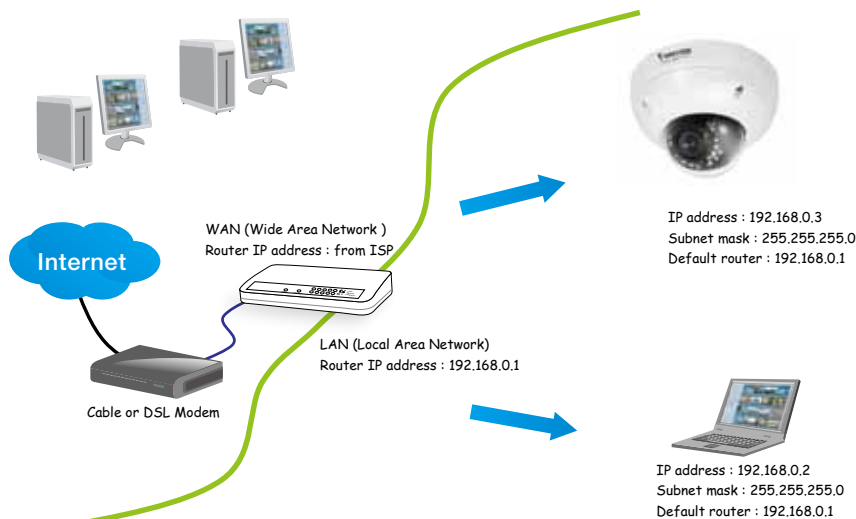

2. In this case, if the Local Area Network (LAN) IP address of your Network Camera is 192.168.0.3, please forward the following ports for the Network Camera on the router.

- HTTP port: default is 80
- RTSP port: default is 554
- RTP port for audio: default is 5558
- RTCP port for audio: default is 5559
- RTP port for video: default is 5556
- RTCP port for video: default is 5557

If you have changed the port numbers on the Network page, please open the ports accordingly on your router. For information on how to forward ports on the router, please refer to your router's user's manual.

3. Find out the public IP address of your router provided by your ISP (Internet Service Provider). Use the public IP and the secondary HTTP port to access the Network Camera from the Internet. Please refer to Network Type on page 57 for details.

## Internet connection with static IP

Choose this connection type if you are required to use a static IP for the Network Camera. Please refer to LAN setting on page 57 for details.

## Internet connection via PPPoE (Point-to-Point over Ethernet)

Choose this connection type if you are connected to the Internet via a DSL Line. Please refer to PPPoE on page 58 for details.

## Software Installation

Installation Wizard 2 (IW2), free-bundled software included on the product CD, helps you set up your Network Camera on the LAN.

1. Install IW2 under the Software Utility directory from the software CD.  
Double-click the IW2 shortcut on your desktop to launch the program.



2. The program will conduct an analysis of your network environment.  
After your network environment is analyzed, please click **Next** to continue the program.

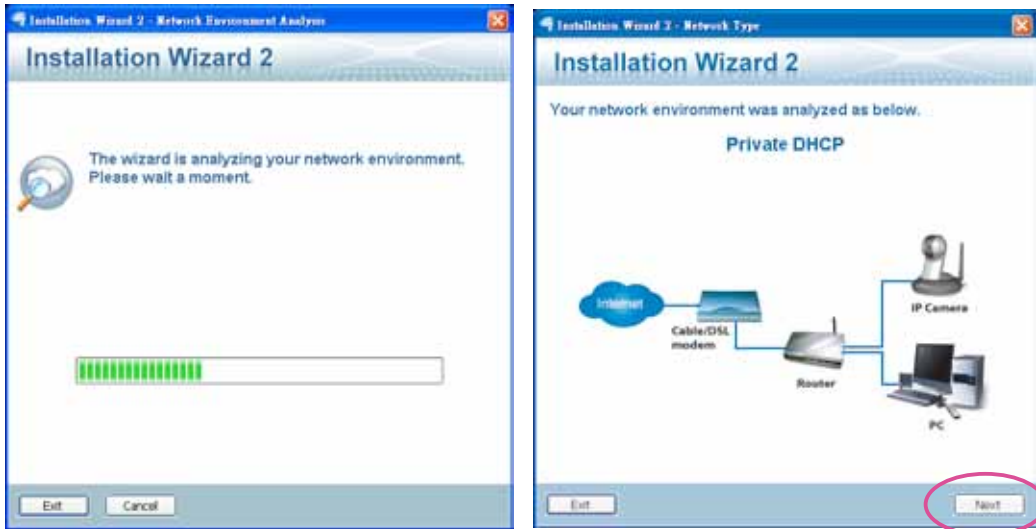

3. The program will search for all VIVOTEK network devices on the same LAN.

4. After a brief search, the installer window will prompt. Click on the MAC and model name that matches the one printed on the product label. You can then double-click on the address to open a management session with the Network Camera.



## Ready to Use

1. A browser session with the Network Camera should prompt as shown below.
2. You should be able to see live video from your camera. You may also install the 32-channel recording software from the software CD in a deployment consisting of multiple cameras. For its installation details, please refer to its related documents.



### To adjust the viewing angle -- 3-axis mechanism design

1. Loosen the tilt adjustment screws and then turn the lens module up or down. Upon completion, tighten the screw.
2. Turn the lens to adjust the image orientation.

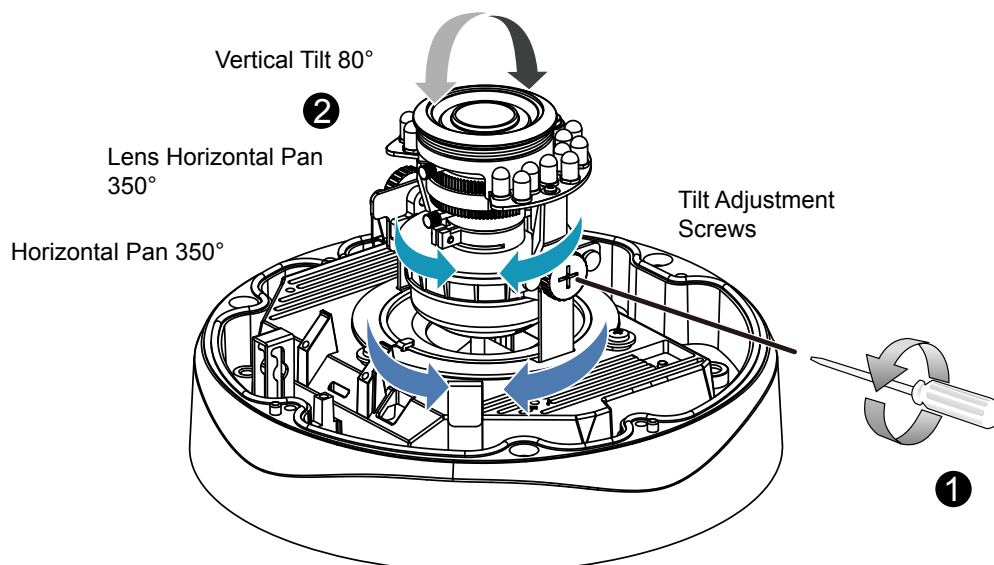

## **To adjust the zoom factor and focus range**

1. Loosen the zoom controller and then adjust zoom factor by moving the controller left and right. Upon completion, tighten the zoom controller screw.
2. Loosen the focus controller and then adjust focus range by moving the controller left and right. Upon completion, tighten the focus controller screw.

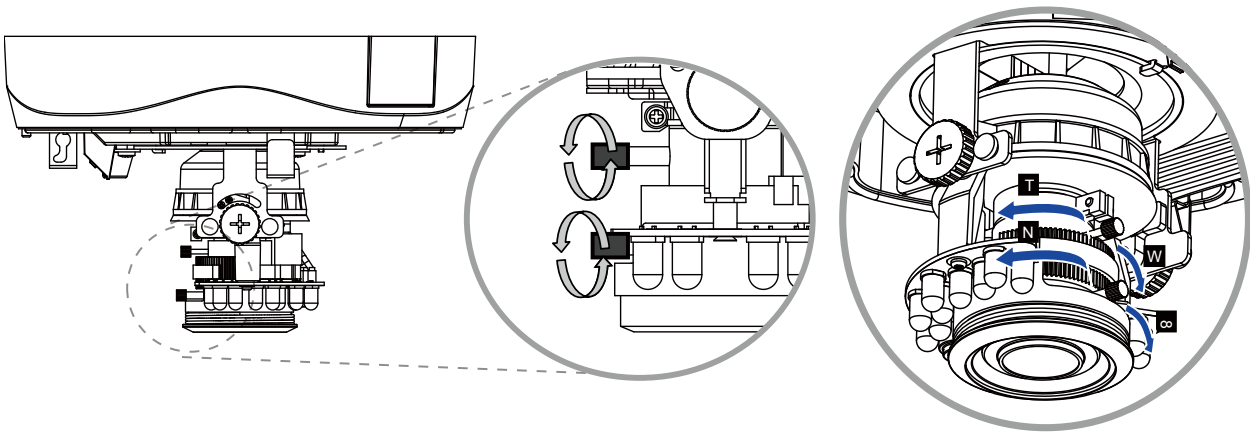

## **Completion**

1. Install the black cover.
2. Attach the dome cover to the camera by combining it to the retainer and aligning with the mounting holes.
3. Secure the four dome screws with the supplied hex key wrench. Make sure all parts of the camera are securely installed.

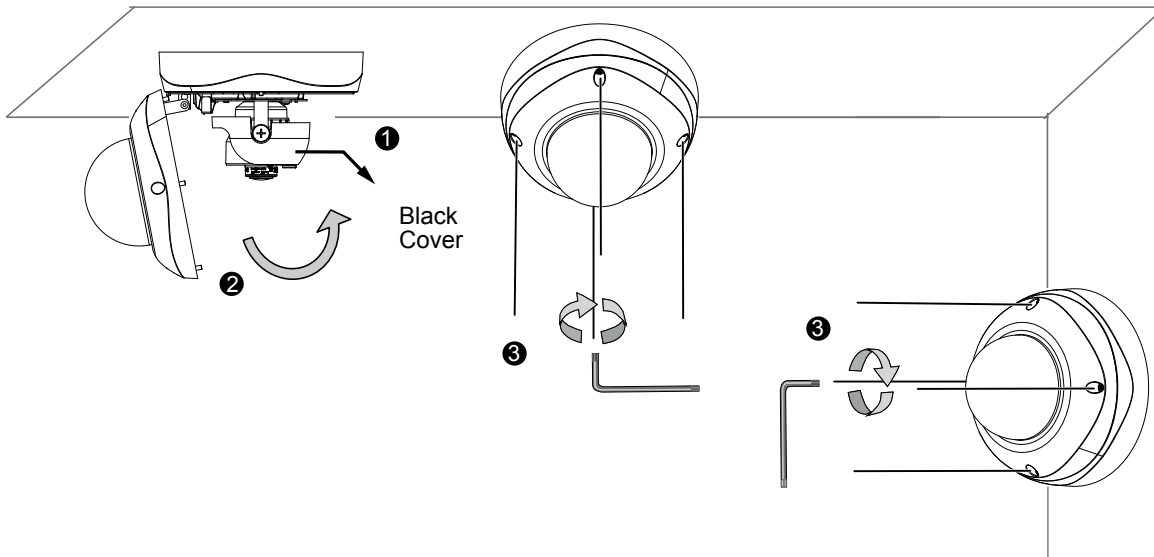

### **NOTE:**

You will find a moisture absorber bag attached to the dome cover. Replace the moisture absorber included in the camera with the one shipped within the accessory bag.

# Accessing the Network Camera

This chapter explains how to access the Network Camera through web browsers, RTSP players, 3GPP-compatible mobile devices, and VIVOTEK recording software.

## Using Web Browsers

Use Installation Wizard 2 (IW2) to access the Network Cameras on LAN.

If your network environment is not a LAN, follow these steps to access the Network Camera:

1. Launch your web browser (ex. Microsoft® Internet Explorer, Mozilla Firefox, or Netscape).
2. Enter the IP address of the Network Camera in the address field. Press **Enter**.
3. The live video will be displayed in your web browser.
4. If it is the first time installing the VIVOTEK network camera, an information bar will pop up as shown below. Follow the instructions to install the required plug-in on your computer.

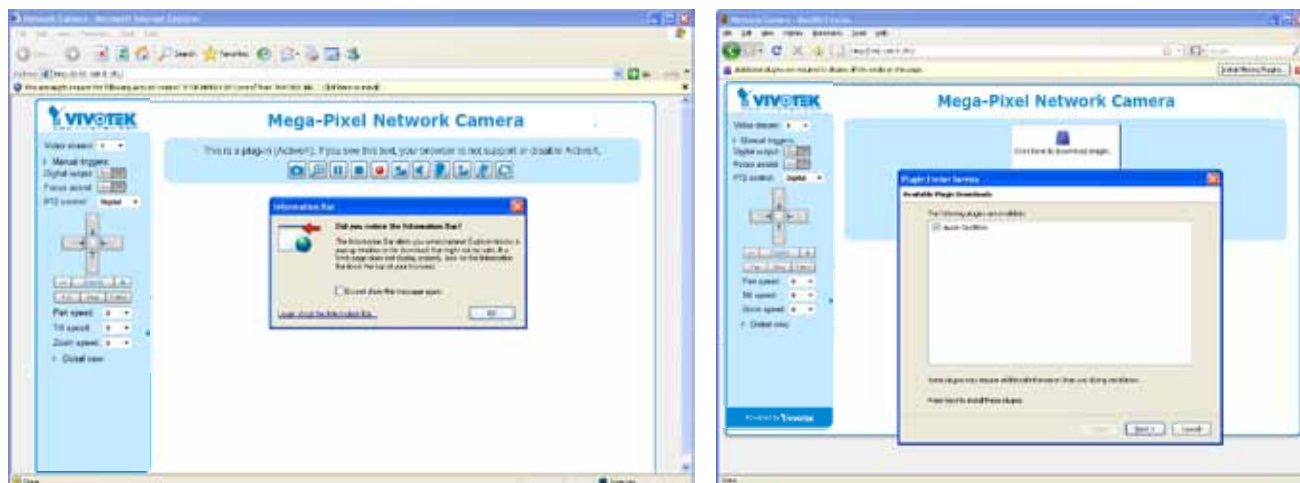

### NOTE:

- For Mozilla Firefox or Netscape users, your browser will use Quick Time to stream the live video. If you don't have Quick Time on your computer, please download it first, then launch the web browser.

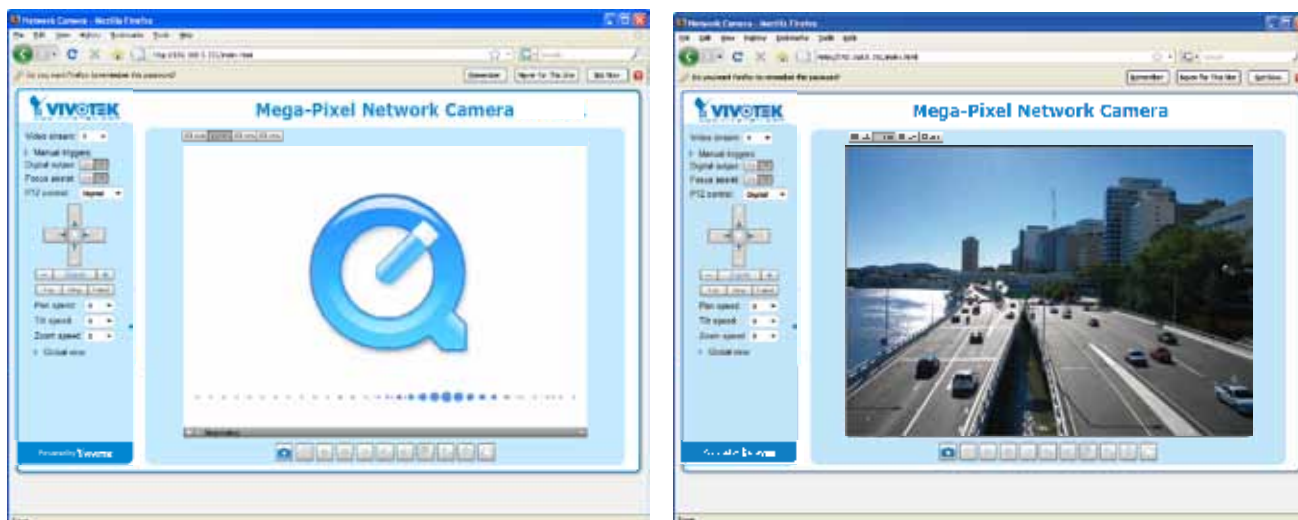

- *By default, the Network Camera is not password-protected. To prevent unauthorized access, it is highly recommended to set a password for the Network Camera. For more information about how to enable password protection, please refer to Security on page 75.*
- *If you see a dialog box indicating that your security settings prohibit running ActiveX® Controls, please enable the ActiveX® Controls for your browser.*

1. Choose **Tools > Internet Options > Security > Custom Level**.

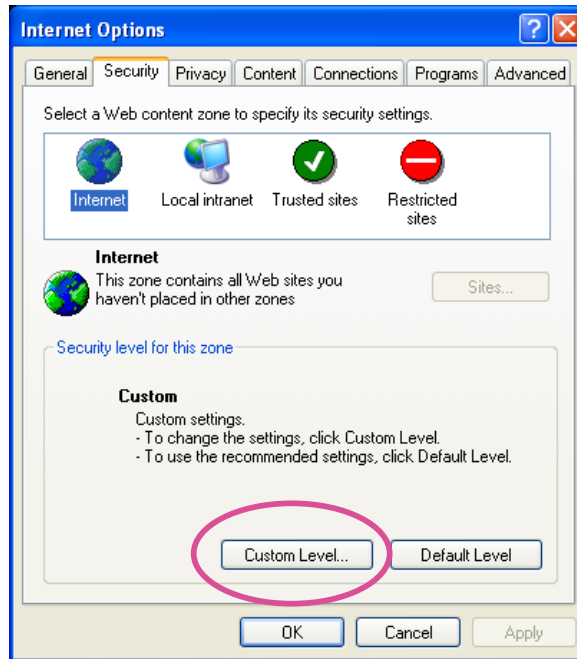

2. Look for **Download signed ActiveX® controls**; select **Enable or Prompt**. Click **OK**.

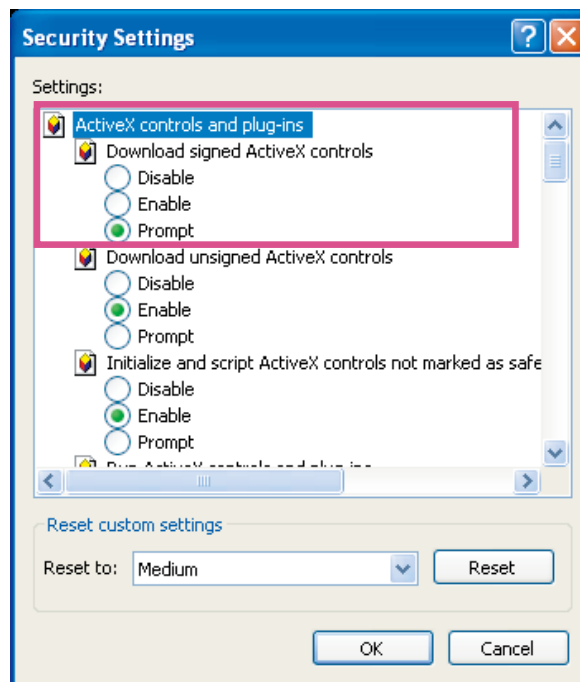

3. Refresh your web browser, then install the ActiveX® control. Follow the instructions to complete installation.

**IMPORTANT!**

- Currently the Network Camera utilizes 32-bit ActiveX plugin. You CAN NOT open a management/view session with the camera using a 64-bit IE browser.
  - If you encounter this problem, try execute the iexplore.exe program from C:\Windows\SysWOW64. A 32-bit version of IE browser will be installed.
  - On Windows 7, the 32-bit explorer browser can be accessed from here:  
[C:\Program Files \(x86\)\Internet Explorer\iexplore.exe](C:\Program Files (x86)\Internet Explorer\iexplore.exe)
-

## Using RTSP Players

To view the MPEG-4 streaming media using RTSP players, you can use one of the following players that support RTSP streaming.



Quick Time Player



Real Player

1. Launch the RTSP player.
2. Choose File > Open URL. A URL dialog box will pop up.
3. The address format is `rtsp://<ip address>:<rtsp port>/<RTSP streaming access name for stream1 or stream2>`

As most ISPs and players only allow RTSP streaming through port number 554, please set the RTSP port to 554. For more information, please refer to RTSP Streaming on page 66.

For example:

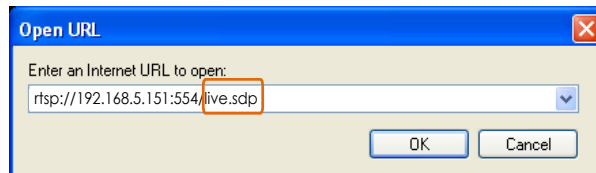

4. The live video will be displayed in your player.  
For more information on how to configure the RTSP access name, please refer to RTSP Streaming on page 66 for details.





## Using 3GPP-compatible Mobile Devices

To view the streaming media through 3GPP-compatible mobile devices, make sure the Network Camera can be accessed over the Internet. For more information on how to set up the Network Camera over the Internet, please refer to Setup the Network Camera over the Internet on page 15.

To utilize this feature, please check the following settings on your Network Camera:

1. Because most players on 3GPP mobile phones do not support RTSP authentication, make sure the authentication mode of RTSP streaming is set to disable.  
For more information, please refer to RTSP Streaming on page 66.
2. As the the bandwidth on 3G networks is limited, you will not be able to use a large video size. Please set the video and audio streaming parameters as listed below.  
For more information, please refer to Stream settings on page 84.

Video Mode	MPEG-4
Frame size	176 x 144
Maximum frame rate	5 fps
Intra frame period	1S
Video quality (Constant bit rate)	40kbps
Audio type (GSM-AMR)	12.2kbps

3. As most ISPs and players only allow RTSP streaming through port number 554, please set the RTSP port to 554. For more information, please refer to RTSP Streaming on page 66.
4. Launch the player on the 3GPP-compatible mobile devices (e.g., Real Player).
5. Type the following URL commands into the player.  
The address format is `rtsp://<public ip address of your camera>:<rtsp port>/<RTSP streaming access name for stream # with small frame size and frame rate>`.  
For example:

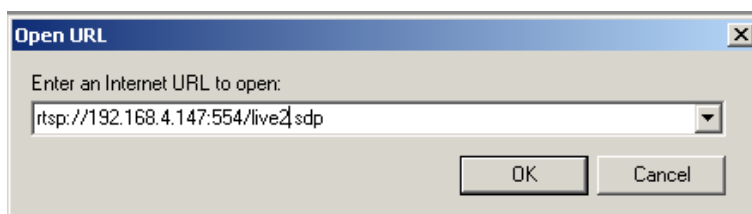

You can configure Stream #2 into the suggested stream settings as listed above for live viewing on a mobile device.

## Using VIVOTEK Recording Software

The product software CD also contains an ST-7501 recording software, allowing simultaneous monitoring and video recording for multiple Network Cameras. Please install the recording software; then launch the program to add the Network Camera to the Channel list. For detailed information about how to use the recording software, please refer to the user's manual of the software or download it from <http://www.vivotek.com>.



# Main Page

This chapter explains the layout of the main page. It is composed of the following sections: VIVOTEK INC. Logo, Host Name, Camera Control Area, Configuration Area, Menu, and Live Video Window.



## VIVOTEK INC. Logo

Click this logo to visit the VIVOTEK website.

## Host Name

The host name can be customized to fit your needs. For more information, please refer to System on page 35.

## Camera Control Area

**Video Stream:** This Network Camera supports multiple streams (stream 1 ~ 4) simultaneously. You can select either one for live viewing. For more information about multiple streams, please refer to page 84 for detailed information.

**Manual Trigger:** Click to enable/disable an event trigger manually. Please configure an event setting on Application page before enable this function. A total of 3 event settings can be configured. For more information about event setting, please refer to page 91. If you want to hide this item on the homepage, please go to **Configuration > System > Homepage Layout > General settings > Customized button** to deselect "show manual trigger button".

**Digital Output:** Click to turn the digital output device on or off.

**Focus Assist**

There are two options for you to fine-tune the camera focus. You can either connect the camera to an analog display device, camera tester, or adjust the focus through networking. Please follow the steps below:

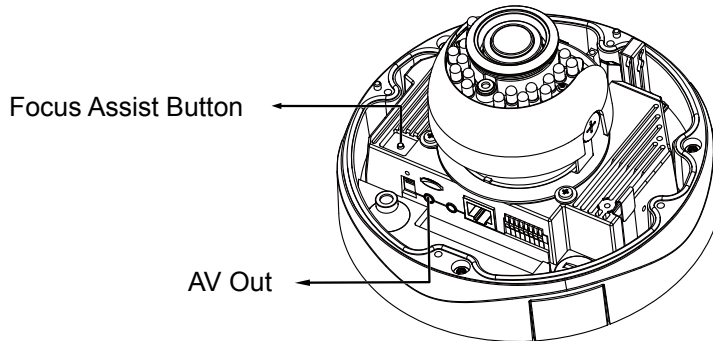

■ Phone-jack AV Out (to BNC)

1. Connect a camera tester to the **AV Out** connector (using the included AV cable).
2. Push the focus assist button on the camera, then a floating indicator will be displayed onscreen showing detailed focus information, which will change in accordance with the manual adjustment.



The pink bar variates according to current focus value.



The pink bar reaches the peak while reaching the best focus.

3. Use the Focus and Zoom adjustment pullers to find the best focus on the target area.
4. Click the “Esc” button to leave the full screen mode.
5. The Video Stream will become “FA” as shown on the right.

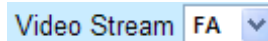

■ Focus Assist button on the management console screen:

1. Click “on” to enable the focus assist function, then the Live Video Window will become full screen for precise focus adjustment.
2. Use the Focus and Zoom adjustment pullers to find the best focus on the target area.
3. Press the “Esc” button to leave the full screen mode.
4. The Video Stream will become “FA” as shown on the right.

**PTZ Panel:** This Network Camera supports both “digital” (e-PTZ) and “mechanical” pan/tilt/zoom control. Please refer to PTZ settings on page 88 for detailed information.

**Global View:** Click on this item to display the Global View window. The Global View window contains a full view image (the largest frame size of the captured video) and a floating frame (the viewing region of the current video stream). The floating frame allows users to control the e-PTZ function (Electronic Pan/Tilt/Zoom). For more information about e-PTZ operation, please refer to E-PTZ Operation on page 88. For more information about how to set up the viewing region of the current video stream, please refer to page 84.

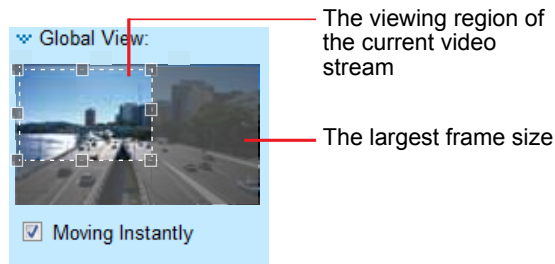

## Configuration Area

**Client Settings:** Click this button to access the client setting page. For more information, please refer to Client Settings on page 32.

**Configuration:** Click this button to access the configuration page of the Network Camera. It is suggested that a password be applied to the Network Camera so that only the administrator can configure the Network Camera. For more information, please refer to Configuration on page 34.

**Language:** Click this button to choose a language for the user interface. Language options are available in: English, Deutsch, Español, Français, Italiano, 日本語, Português, 簡體中文, and 繁體中文. Please note that you can also change a language on the Configuration page; please refer to page 34.

## Hide Button

You can click the hide button to hide the control panel or display the control panel.

## Resize Buttons



Click the Auto button, the video cell will resize automatically to fit the monitor.

Click 100% is to display the original homepage size.

Click 50% is to resize the homepage to 50% of its original size.

Click 25% is to resize the homepage to 25% of its original size.

## Live Video Window

- The following window is displayed when the video mode is set to H.264 / MPEG-4:



**Video Title:** The video title can be configured. For more information, please refer to Video Settings on page 84.

**H.264 / MPEG-4 Protocol and Media Options:** The transmission protocol and media options for H.264 / MPEG-4 video streaming. For further configuration, please refer to Client Settings on page 32.

**Time:** Display the current time. For further configuration, please refer to Media > Image > Genral settings on page 75.



**Title and Time:** The video title and time can be stamped on the streaming video. For further configuration, please refer to Media > Image > General settings on page 75.



**Video and Audio Control Buttons:** Depending on the Network Camera model and Network Camera configuration, some buttons may not be available.

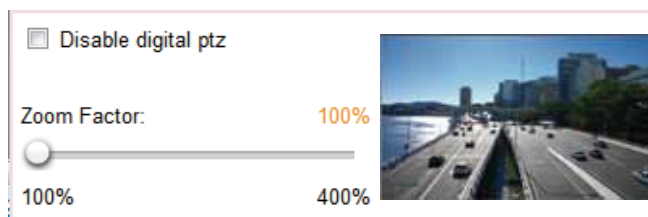

 **Snapshot:** Click this button to capture and save still images. The captured images will be displayed in a pop-up window. Right-click the image and choose **Save Picture As** to save it in JPEG (\*.jpg) or BMP (\*.bmp) format.



 **Digital Zoom:** Click and uncheck “Disable digital zoom” to enable the zoom operation. The navigation screen indicates the part of the image being magnified. To control the zoom level, drag the slider bar. To move to a different area you want to magnify, drag the navigation screen.







 **Pause:** Pause the transmission of the streaming media. The button becomes the  **Resume** button after clicking the Pause button.



 **Stop:** Stop the transmission of the streaming media. Click the  **Resume** button to continue transmission.



 **Start MP4 Recording:** Click this button to record video clips in MP4 file format to your computer. Press the  **Stop MP4 Recording** button to end recording. When you exit the web browser, video recording stops accordingly. To specify the storage destination and file name, please refer to MP4 Saving Options on page 33 for details.

 **Volume:** When the  **Mute** function is not activated, move the slider bar to adjust the volume on the local computer.

 **Mute:** Turn off the volume on the local computer. The button becomes the  **Audio On** button after clicking the Mute button.

 **Talk:** Click this button to talk to people around the Network Camera. Audio will project from the external speaker connected to the Network Camera. Click this button  again to end talking transmission.

 **Mic Volume:** When the  **Mute** function is not activated, move the slider bar to adjust the microphone volume on the local computer.

 **Mute:** Turn off the  **Mic volume** on the local computer. The button becomes the  **Mic On** button after clicking the Mute button.

 **Full Screen:** Click this button to switch to full screen mode. Press the “Esc” key to switch back to normal mode.

- The following window is displayed when the video mode is set to MJPEG:





**Video Title:** The video title can be configured. For more information, please refer to Media > Image on page 75.

**Time:** Display the current time. For more information, please refer to Media > Image on page 75.



**Title and Time:** Video title and time can be stamped on the streaming video. For more information, please refer to Media > Image on page 75.

**Video and Audio Control Buttons:** Depending on the Network Camera model and Network Camera configuration, some buttons may not be available.

 **Snapshot:** Click this button to capture and save still images. The captured images will be displayed in a pop-up window. Right-click the image and choose **Save Picture As** to save it in JPEG (\*.jpg) or BMP (\*.bmp) format.

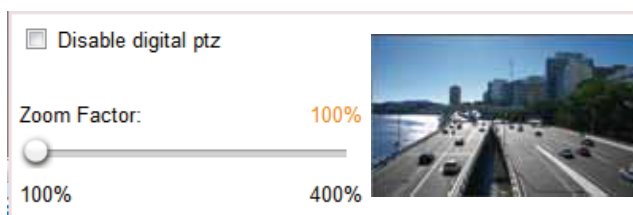
 **Digital Zoom:** Click and uncheck “Disable digital zoom” to enable the zoom operation. The navigation screen indicates the part of the image being magnified. To control the zoom level, drag the slider bar. To move to a different area you want to magnify, drag the navigation screen.



 **Start MP4 Recording:** Click this button to record video clips in MP4 file format to your computer. Press the  **Stop MP4 Recording** button to end recording. When you exit the web browser, video recording stops accordingly. To specify the storage destination and file name, please refer to MP4 Saving Options on page 33 for details.

 **Full Screen:** Click this button to switch to full screen mode. Press the “Esc” key to switch back to normal mode.

# Client Settings

This chapter explains how to select the stream transmission mode and saving options on the local computer. When completed with the settings on this page, click **Save** on the page bottom to enable the settings.

## H.264 / MPEG-4 Media Options

H.264/MPEG-4 Media Options

Video and Audio

Video Only

Audio Only

Select to stream video or audio data or both. This is enabled only when the video mode is set to H.264 or MPEG-4.

## H.264 / MPEG-4 Protocol Options

H.264/MPEG-4 Protocol Options

UDP Unicast

UDP Multicast

TCP

HTTP

Depending on your network environment, there are four transmission modes of H.264 or MPEG-4 streaming:

**UDP unicast:** This protocol allows for more real-time audio and video streams. However, network packets may be lost due to network burst traffic and images may be broken. Activate UDP connection when occasions require time-sensitive responses and the video quality is less important. Note that each unicast client connecting to the server takes up additional bandwidth and the Network Camera allows up to ten simultaneous accesses.

**UDP multicast:** This protocol allows multicast-enabled routers to forward network packets to all clients requesting streaming media. This helps to reduce the network transmission load of the Network Camera while serving multiple clients at the same time. Note that to utilize this feature, the Network Camera must be configured to enable multicast streaming at the same time. For more information, please refer to RTSP Streaming on page 66.

**TCP:** This protocol guarantees the complete delivery of streaming data and thus provides better video quality. The downside of this protocol is that its real-time effect is not as good as that of the UDP protocol.

**HTTP:** This protocol allows the same quality as TCP protocol without needing to open specific ports for streaming under some network environments. Users inside a firewall can utilize this protocol to allow streaming data through.



## MP4 Saving Options

**MP4 Saving Options**

Folder:

File name prefix:

Add date and time suffix to file name

Users can record live video as they are watching it by clicking  Start MP4 Recording on the main page. Here, you can specify the storage destination and file name.

**Folder:** Specify a storage destination for the recorded video files.

**File name prefix:** Enter the text that will be appended to the front of the video file name.

**Add date and time suffix to the file name:** Select this option to append the date and time to the end of the file name.

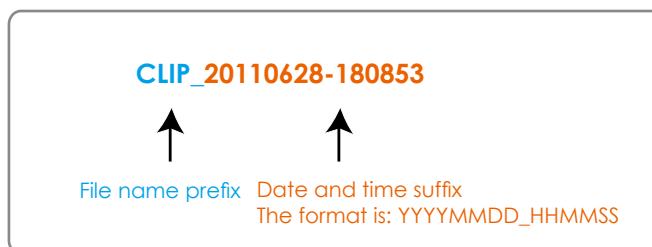

## Local Streaming Buffer Time

**Local streaming buffer time**

Millisecond

Due to the unsteady bandwidth flow, the live streaming may lag and not be very smoothly. If you enable this option, the live streaming will be stored on the camera's buffer area for a few seconds before playing on the live viewing window. This will help you see the streaming more smoothly. If you enter 3000 Millisecond, the streaming will delay for 3 seconds.

# Configuration

Click **Configuration** on the main page to enter the camera setting pages. Note that only Administrators can access the configuration page.

VIVOTEK offers an easy-to-use user interface that helps you set up your network camera with minimal effort. To simplify the setting procedure, two types of user interfaces are available: Advanced Mode for professional users and Basic Mode for entry-level users. Some advanced functions (PTZ/ Event/ Recording/ Local storage) are not displayed in Basic Mode.

If you want to set up advanced functions, please click **[Advanced Mode]** on the bottom of the configuration list to quickly switch to Advanced Mode.

In order to simplify the user interface, the detailed information will be hidden unless you click on the function item. When you click on the first sub-item, the detailed information for the first sub-item will be displayed; when you click on the second sub-item, the detailed information for the second sub-item will be displayed and that of the first sub-item will be hidden.

The following is the interface of the Basic Mode and the Advanced Mode:

## Basic Mode

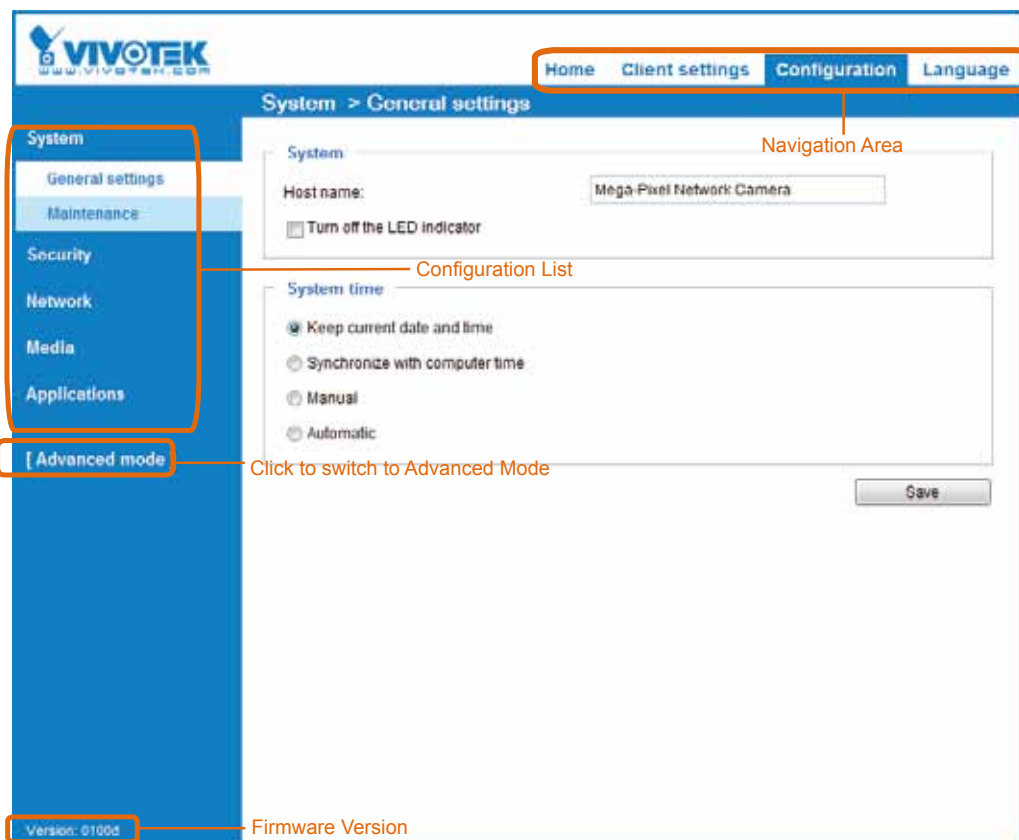

## Advanced Mode

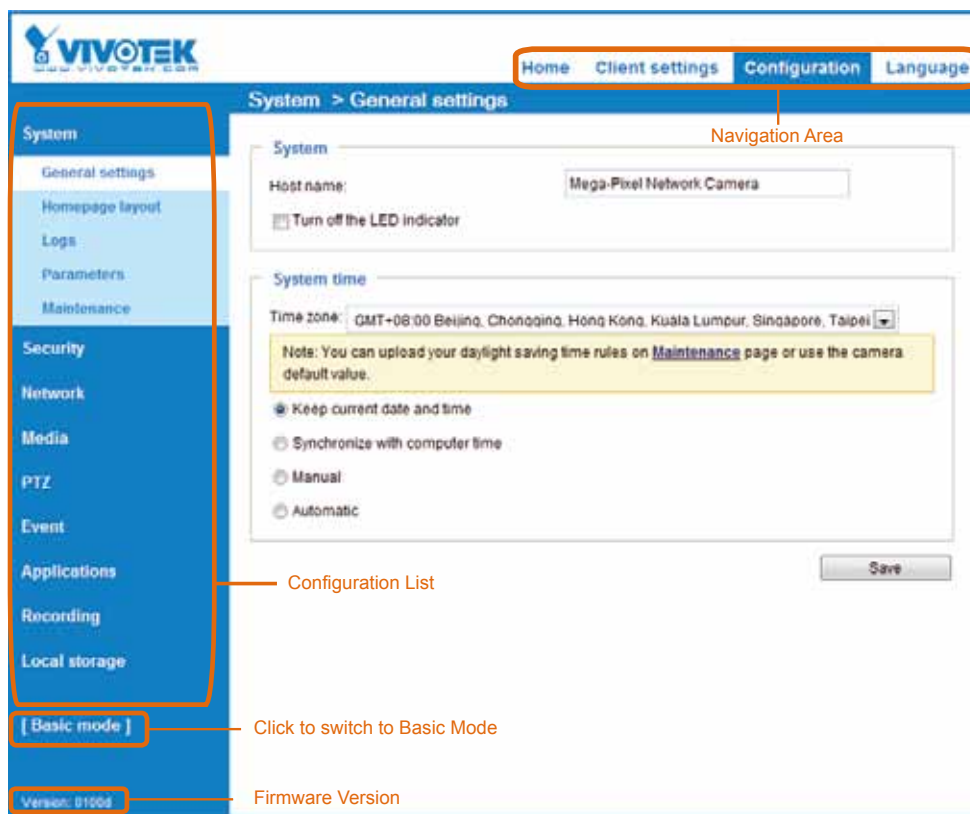

Each function on the configuration list will be explained in the following sections. Those functions that are displayed only in Advanced Mode are marked with **Advanced Mode**. If you want to set up advanced functions, please click **[Advanced Mode]** on the bottom of the configuration list to quickly switch over.

Navigation Area provides an instant switch among **Home** page (the monitoring page for live viewing), **Client settings**, **Configuration** page, and multi-language selection.

## System > General settings

This section explains how to configure the basic settings for the Network Camera, such as the host name and system time. It is composed of the following two columns: System, and System Time. When finished with the settings on this page, click **Save** at the bottom of the page to enable the settings.

### System

**System**

Host name:

Turn off the LED indicator

**Host name:** Enter a desired name for the Network Camera. The text will be displayed at the top of the main page, and also on the view cell of ST-7501 and VAST management software.

**Turn off the LED indicators:** If you do not want others to notice the network camera is in operation, you can select this option to turn off the LED indicators.

## System time

**System time**

Time zone:

Note: You can upload your daylight saving time rules on [Maintenance](#) page or use the camera default value.

Keep current date and time

Synchronize with computer time

Manual

Automatic

**Keep current date and time:** Select this option to preserve the current date and time of the Network Camera. The Network Camera's internal real-time clock maintains the date and time even when the power of the system is turned off.

**Synchronize with computer time:** Select this option to synchronize the date and time of the Network Camera with the local computer. The read-only date and time of the PC is displayed as updated.

**Manual:** The administrator can enter the date and time manually. Note that the date and time format are [yyyy/mm/dd] and [hh:mm:ss].

**Automatic:** The Network Time Protocol is a protocol which synchronizes computer clocks by periodically querying an NTP Server.

**NTP server:** Assign the IP address or domain name of the time-server. Leaving the text box blank connects the Network Camera to the default time servers.

**Update interval:** Select to update the time using the NTP server on an hourly, daily, weekly, or monthly basis.

**Time zone Advanced Mode:** Select the appropriate time zone from the list. If you want to upload Daylight Savings Time rules, please refer to **System > Maintenance > Import/ Export files** on page 43 for details.

## System > Homepage layout Advanced Mode

This section explains how to set up your own customized homepage layout.

### General settings

This column shows the settings of your homepage layout. You can manually select the background and font colors in Theme Options (the second tab on this page). The settings will be displayed automatically in this Preview field. The following shows the homepage using the default settings:



- Hide Powered by VIVOTEK: If you check this item, it will be removed from the homepage.

### Logo graph

Here you can change the logo at the top of your homepage.

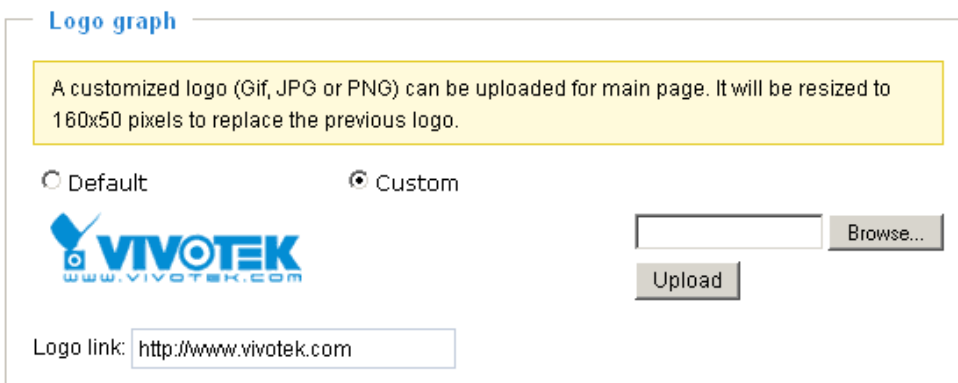

Follow the steps below to upload a new logo:

1. Click **Custom** and the Browse field will appear.
2. Select a logo from your files.
3. Click **Upload** to replace the existing logo with a new one.
4. Enter a website link if necessary.
5. Click **Save** to enable the settings.

### Customized button

If you want to hide manual trigger buttons on the homepage, please uncheck this item. This item is checked by default.

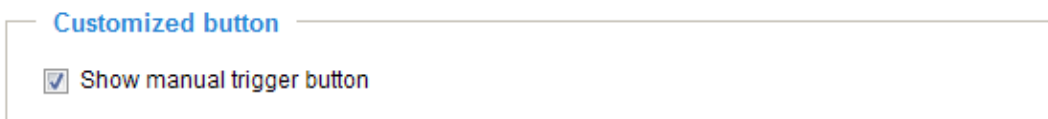

## Theme Options

Here you can change the color of your homepage layout. There are three types of preset patterns for you to choose from. The new layout will simultaneously appear in the **Preview** filed. Click **Save** to enable the settings.

The screenshot shows the 'Theme options' tab in the VIVOTEK web interface. It features a preview window and a configuration panel. Callouts point to the following elements:

- Font Color of the Video Title:** Points to the 'Mega-Pixel Network' title in the preview.
- Font Color:** Points to the 'Video stream' dropdown menu.
- Background Color of the Control Area:** Points to the background of the control panel in the preview.
- Font Color of the Configuration Area:** Points to the 'Manual triggers' text in the preview.
- Background Color of the Configuration Area:** Points to the background of the configuration panel in the preview.
- Background Color of the Video Area:** Points to the background of the video player in the preview.
- Frame Color:** Points to the border of the video player in the preview.
- Preset patterns:** Points to the 'Themes' section showing three different layout options.

The configuration panel includes a 'Color' section with the following settings:

- Font color: #000000
- Font color of video title: #098BD6
- Bk color of control area: #C4EAFF
- Bk color of configuration area: #0186D1
- Bk color of video area: #C4EAFF
- Frame color: #0186D1

A 'Save' button is located at the bottom right of the configuration panel.

This screenshot shows the VIVOTEK web interface with a light theme selected. The background of the control area and configuration area is light gray, and the video area has a light blue background. The 'Mega-Pixel Network' title is in a dark gray font.

This screenshot shows the VIVOTEK web interface with a dark theme selected. The background of the control area and configuration area is dark gray, and the video area has a dark blue background. The 'Mega-Pixel Network' title is in a light gray font.

■ Follow the steps below to set up the customized homepage:

1. Click **Custom** on the left column.
2. Click the field where you want to change the color on the right column.

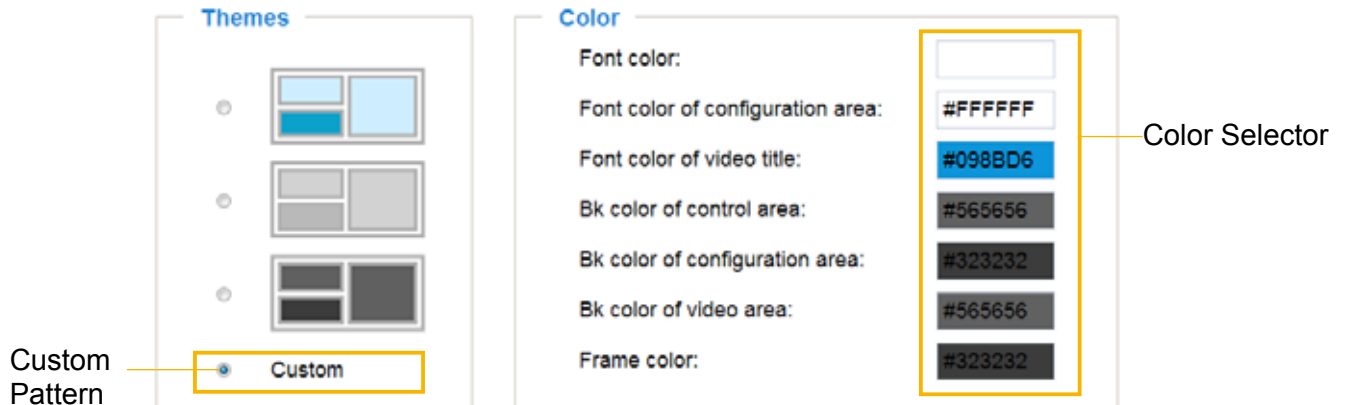

3. The palette window will pop up as shown below.

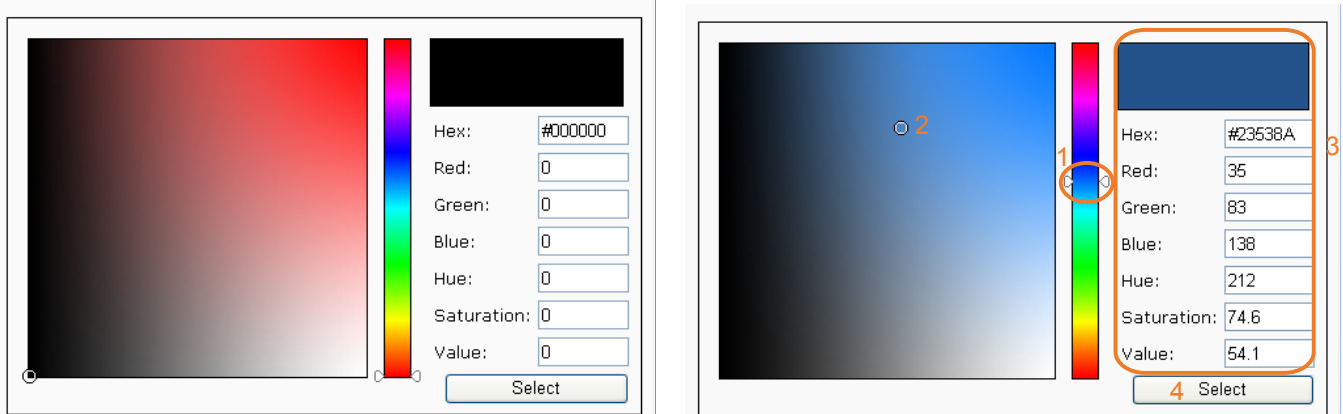

4. Drag the slider bar and click on the left square to select a desired color.
5. The selected color will be displayed in the corresponding fields and in the **Preview** column.
6. Click **Save** to enable the settings.

## System > Logs Advanced Mode

This section explains how to configure the Network Camera to send the system log to a remote server as backup.

### Log server settings

**Log server settings**

Enable remote log

IP address:

port:

Follow the steps below to set up the remote log:

1. Select **Enable remote log**.
2. In the IP address text box, enter the IP address of the remote server.
2. In the port text box, enter the port number of the remote server.
3. When completed, click **Save** to enable the setting.

You can configure the Network Camera to send the system log file to a remote server as a log backup. Before utilizing this feature, it is suggested that the user install a log-recording tool to receive system log messages from the Network Camera. An example is Kiwi Syslog Daemon. Visit <http://www.kiwisyslog.com/kiwi-syslog-daemon-overview/>.

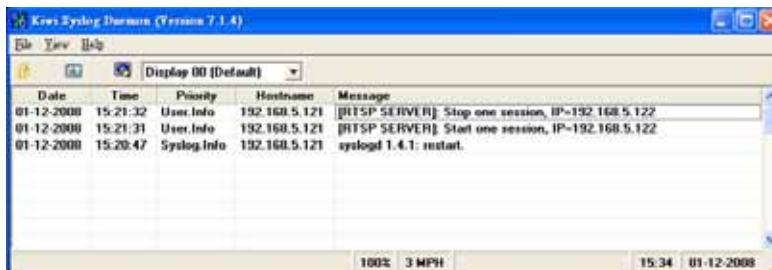

### System log

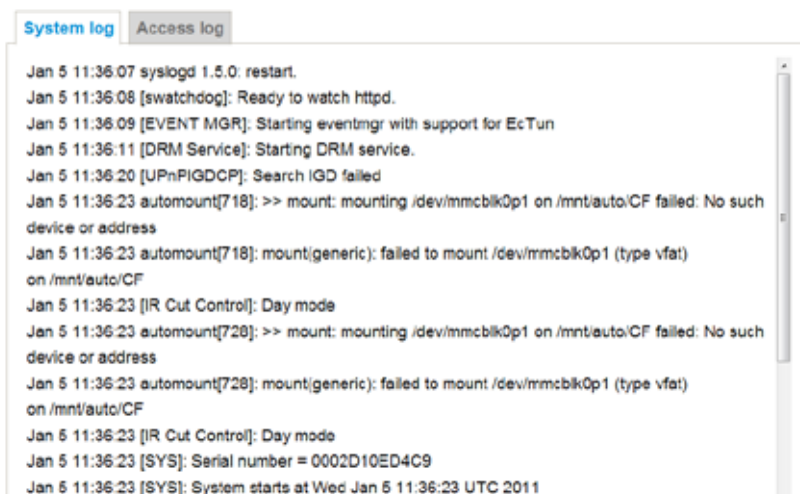

This column displays the system log in a chronological order. The system log is stored in the Network Camera's buffer area and will be overwritten when reaching a certain limit.



## Access log

System log

Access log

```
Jan 5 11:36:28 [RTSP SERVER]: Start one session, IP=172.16.2.52
Jan 5 11:49:15 [RTSP SERVER]: Start one session, IP=192.168.4.105
Jan 5 13:11:20 [RTSP SERVER]: Start one session, IP=192.168.4.105
```

Access log displays the access time and IP address of all viewers (including operators and administrators) in a chronological order. The access log is stored in the Network Camera's buffer area and will be overwritten when reaching a certain limit.

## System > Parameters Advanced Mode

The View Parameters page lists the entire system's parameters. If you need technical assistance, please provide the information listed on this page.

### Parameters

```
system_hostname='Mega-Pixel Network Camera'
system_ledoff='0'
system_lowlight='1'
system_date='2000/01/04'
system_time='03:02:28'
system_datetime=''
system_ntp=''
system_timezoneindex='320'
system_daylight_enable='0'
system_daylight_dstactualmode='1'
system_daylight_auto_begintime='NONE'
system_daylight_auto_endtime='NONE'
system_daylight_timezones=',-360,-320,-280,-240,-241,-200,-201,-1'
system_updateinterval='0'
system_info_modelname='FD8335H'
system_info_extendedmodelname='FD8335H'
system_info_serialnumber='00D2813500AA'
system_info_firmwareversion='FD8335-VVTK-0100d'
system_info_language_count='9'
system_info_language_i0='English'
system_info_language_i1='Deutsch'
system_info_language_i2='Español'
system_info_language_i3='Français'
system_info_language_i4='Italiano'
system_info_language_i5='日本語'
system_info_language_i6='Português'
system_info_language_i7='简体中文'
system_info_language_i8='繁體中文'
```

## System > Maintenance

This chapter explains how to restore the Network Camera to factory default, upgrade firmware version, etc.

### General settings > Upgrade firmware

This feature allows you to upgrade the firmware of your Network Camera. It takes a few minutes to complete the process.

**Note: Do not power off the Network Camera during the upgrade!**

Follow the steps below to upgrade the firmware:

1. Download the latest firmware file from the VIVOTEK website. The file is in .pkg file format.
2. Click **Browse...** and specify the firmware file.
3. Click **Upgrade**. The Network Camera starts to upgrade and will reboot automatically when the upgrade completes.

If the upgrade is successful, you will see “Reboot system now!! This connection will close”. After that, re-access the Network Camera.

The following message is displayed when the upgrade has succeeded.

The following message is displayed when you have selected an incorrect firmware file.

### General settings > Reboot

This feature allows you to reboot the Network Camera, which takes about one minute to complete. When completed, the live video page will be displayed in your browser. The following message will be displayed during the reboot process.

If the connection fails after rebooting, manually enter the IP address of the Network Camera in the address field to resume the connection.

## General settings > Restore

**Restore**

Restore all settings to factory default except settings in

Network
  Daylight saving time
  Custom language

This feature allows you to restore the Network Camera to factory default settings.

**Network:** Select this option to retain the Network Type settings (please refer to Network Type on page 57).

**Daylight Saving Time:** Select this option to retain the Daylight Saving Time settings (please refer to Import/Export files below on this page).

**Custom Language:** Select this option to retain the Custom Language settings.

If none of the options is selected, all settings will be restored to factory default. The following message is displayed during the restoring process.

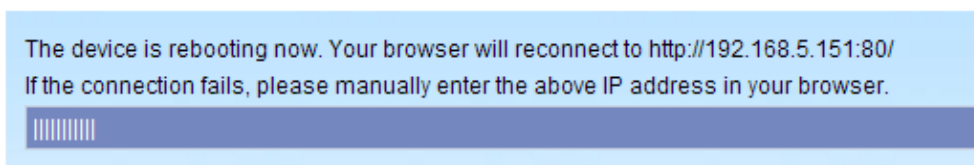

## Import/Export files Advanced Mode

This feature allows you to Export / Update daylight saving time rules, custom language file, configuration file, and server status report.

General settings Import/Export files

**Export files**

Export daylight saving time configuration file

Export language file

Export configuration file

Export server status report

**Upload files**

Update daylight saving time rules:

Update custom language file:

Upload configuration file:

**Export daylight saving time configuration file:** Click to set the start and end time of DST (Daylight Saving).

Follow the steps below to export:

1. In the Export files column, click **Export** to export the daylight saving time configuration file from the Network Camera.
2. A file download dialog will pop up as shown below. Click **Open** to review the XML file or click **Save** to store the file for editing.

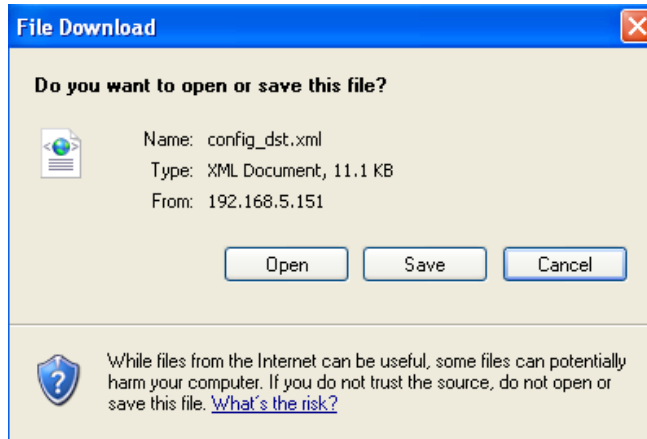

3. Open the file with Microsoft® Notepad and locate your time zone; set the start and end time of DST. When completed, save the file.

In the example below, DST begins each year at 2:00 a.m. on the second Sunday in March and ends at 2:00 a.m. on the first Sunday in November.

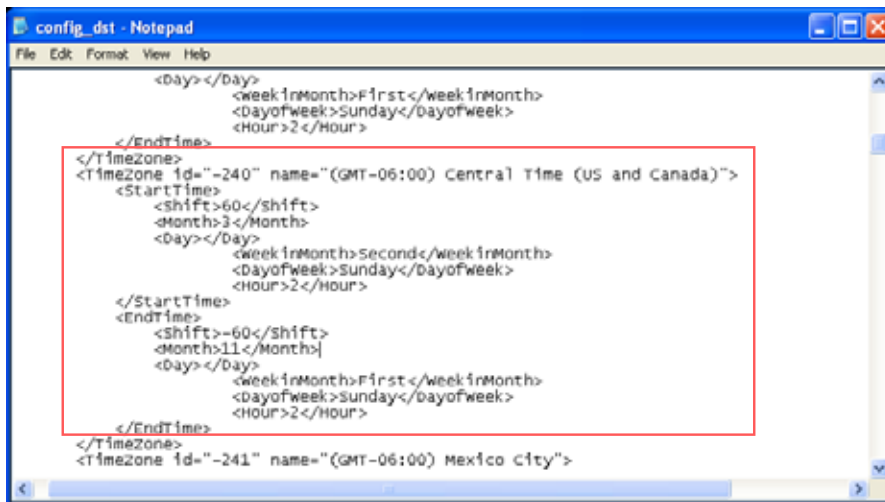

Update daylight saving time rules: Click **Browse...** and specify the XML file to update.

If the incorrect date and time are assigned, you will see the following warning message when uploading the file to the Network Camera.

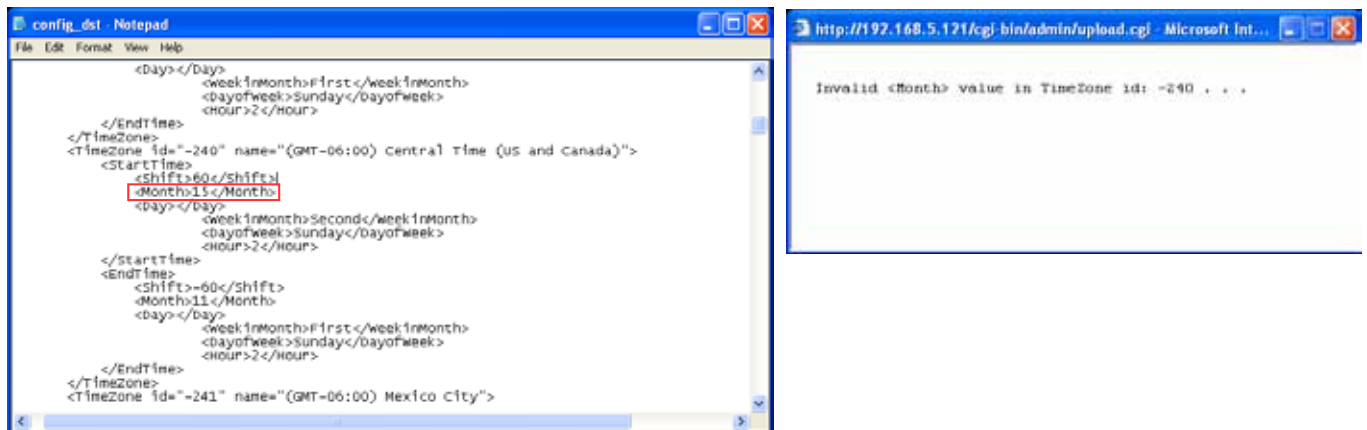

The following message is displayed when attempting to upload an incorrect file format.

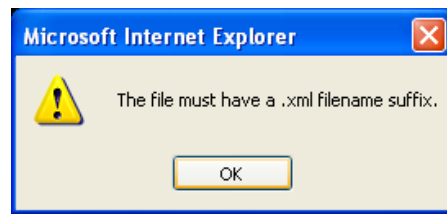

Export language file: Click to export language strings. VIVOTEK provides nine languages: English, Deutsch, Español, Français, Italiano, 日本語, Português, 簡體中文, and 繁體中文.

Update custom language file: Click **Browse...** and specify your own custom language file to upload.

Export configuration file: Click to export all parameters for the device and user-defined scripts.

Update configuration file: Click **Browse...** to update a configuration file. Please note that the model and firmware version of the device should be the same as the configuration file. If you have set up a fixed IP or other special settings for your device, it is not suggested to update a configuration file.

Export server status report: Click to export the current server status report, such as time, logs, parameters, process status, memory status, file system status, network status, kernel message ... and so on.

## Security > User Account

This section explains how to enable password protection and create multiple accounts.

### Root Password

The administrator account name is “root”, which is permanent and can not be deleted. If you want to add more accounts in the Manage User column, please apply the password for the “root” account first.

1. Type the password identically in both text boxes, then click **Save** to enable password protection.
2. A window will be prompted for authentication; type the correct user’s name and password in their respective fields to access the Network Camera.

### Privilege Management **Advanced Mode**

**Digital Output & PTZ control:** You can modify the manage privilege of operators or viewers. Check or uncheck the item, then click **Save** to enable the settings. If you give Viewers the privilege, Operators will also have the ability to control the Network Camera through the main page. (Please refer to Configuration on page 34).

**Allow anonymous viewing:** If you check this item, any client can access the live stream without entering a User ID and Password.

### Account Management

Administrators can add up to 20 user accounts.

1. Input the new user’s name and password.
2. Select the privilege level for the new user account. Click **Add** to enable the setting.

Access rights are sorted by user privilege (Administrator, Operator, and Viewer). Only administrators can access the Configuration page. Though operators cannot access the Configuration page, they can use the URL Commands to get and set the value of parameters. For more information, please refer to URL Commands of the Network Camera on page 118. Viewers access only the main page for live viewing.

Here you also can change a user’s access rights or delete user accounts.

1. Select an existing account to modify.
2. Make necessary changes and click **Update** or **Delete** to enable the setting.

## Security > HTTPS (Hypertext Transfer Protocol over SSL) Advanced Mode

This section explains how to enable authentication and encrypted communication over SSL (Secure Socket Layer). It helps protect streaming data transmission over the Internet on higher security level.

### Create and Install Certificate Method

Before using HTTPS for communication with the Network Camera, a **Certificate** must be created first. There are three ways to create and install a certificate:

#### Create self-signed certificate

1. Select this option from a pull-down menu.
2. In the first column, select **Enable HTTPS secure connection**, then select a connection option: "HTTP & HTTPS" or "HTTPS only".
3. Click **Create certificate** to generate a certificate.

The screenshot shows the 'HTTPS' configuration page. The 'Enable HTTPS secure connection' checkbox is checked. Under 'Mode', 'HTTP & HTTPS' is selected. Under 'Certificate', the 'method' dropdown is set to 'Create self-signed certificate'. The 'Certificate information' section is expanded, showing fields for Country (TW), State or province (Asia), Locality (Asia), Organization (VIVOTEK.Inc), Organization unit (VIVOTEK.Inc), Common name (www.vivotek.com), and Validity (3650 days). A 'Create certificate' button is highlighted with a yellow box. A blue dialog box with a progress bar and the text 'Please wait while the certificate is being generated...' is overlaid on the form.

4. The Certificate Information will automatically be displayed as shown below. You can click **Certificate properties** to view detailed information about the certificate.

The screenshot shows the 'Certificate information' panel. The 'Status' is 'Active'. The 'method' is 'Create self-signed certificate'. The 'Certificate information' section is expanded, showing fields for Country (TW), State or province (Asia), Locality (Asia), Organization (VIVOTEK.Inc), Organization unit (VIVOTEK.Inc), Common name (www.vivotek.com), and Validity (3650 days). A 'Certificate properties' link is highlighted in blue, and a 'Remove certificate' button is visible at the bottom right.

- Click **Home** to return to the main page. Change the address from “<http://>” to “<https://>” in the address bar and press **Enter** on your keyboard. Some Security Alert dialogs will pop up. Click **OK** or **Yes** to enable HTTPS.

**https://**

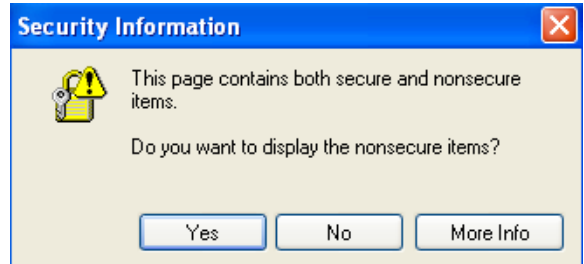
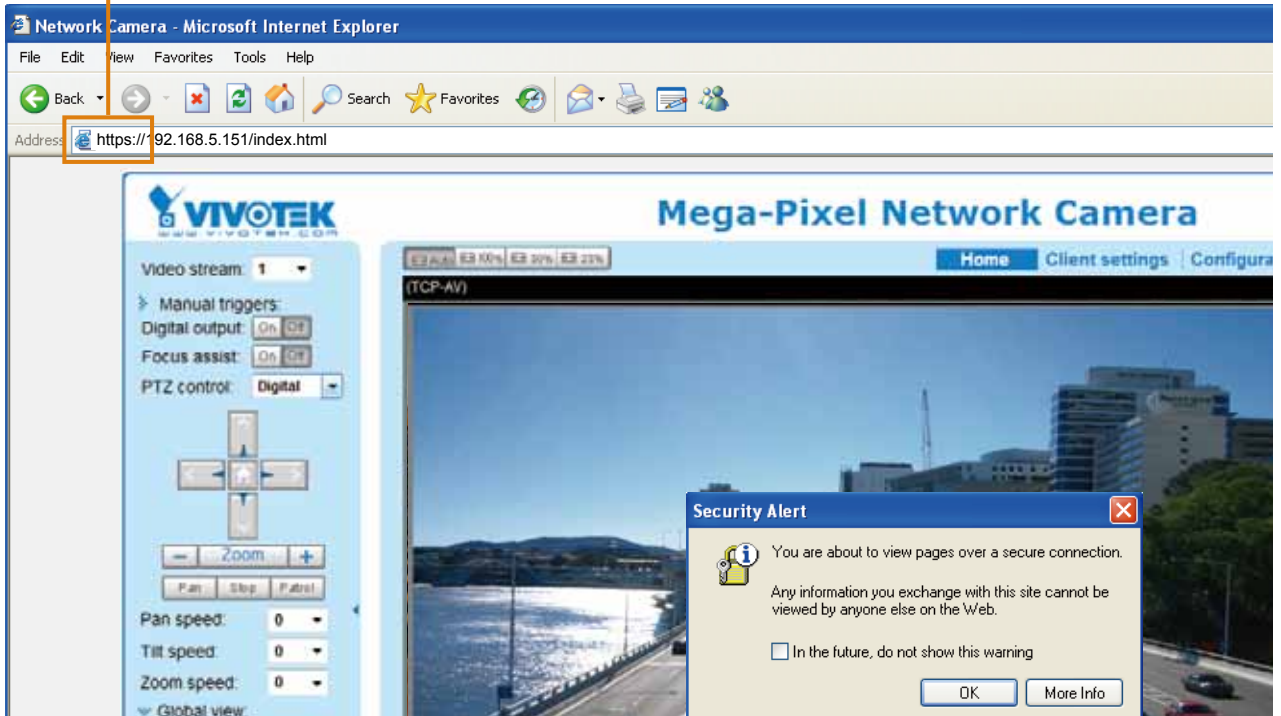



**Create certificate and install** : Select this option if you want to create a certificate from a certification authority.

1. Select this option from a method pull-down menu.
2. Click **Create certificate** to generate the certificate.

▼ Certificate:

**Certificate information**

Status: Not installed

method: Create certificate request and install ▼  
Create self-signed certificate  
Create certificate request and install

Country:

State or province:

Locality:

Organization:

Organization unit:

Common name:

Create certificate

Please wait while the certificate is being generated...



3. The following information will appear in a pop-up window after clicking **Create**. If you see the following Information bar, click **OK** and click on the Information bar at the top of the page to allow pop-ups.

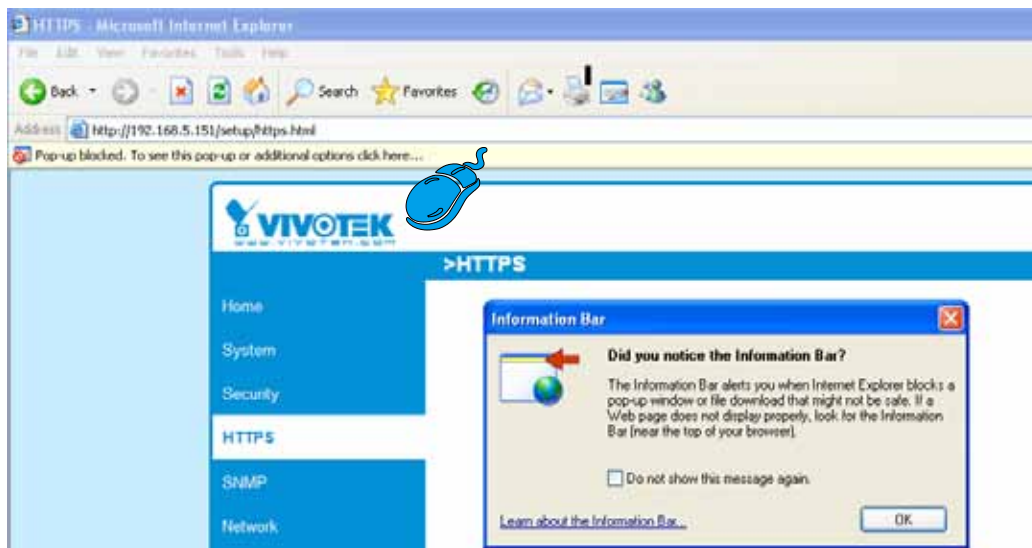

- The Certificate Information will automatically be displayed in the third column as shown below. You can click **Property** to see detailed information about the certificate.

**Create Certificate Request Completed**

Copy the PEM format request below and send it to a CA for identify validation. After that, you have to install it by clicking the "Upload" button on HTTPS page.

**Certificate Request (PEM format)**

```
-----BEGIN CERTIFICATE REQUEST-----
MIIBuDCCASECADB5MQswCQYDVQQGEwJVUVzERMA8GA1UECBMIUHJvdmluY2UxLjAQ
BgNVBAsTCUNpdHkgTmFtZTEaMBGGA1UEChMRMT3JnYW5pemFoaW9uIE5hbWUxLjAQ
BgNVBAsTCVVueXQgTmFtZTEaMBGGA1UEAxMKSVAgQWRkcmlVzcCBnzANBgkqhkiG
9w0BAQEFAA0BjQAwYkCgYEAuOT75EY52gsSyPFMxZ7wHdQ1obPescsXLUx9DFw6
OMRheukFaXFDkM+5xk+K5oEPBPqj77yhH+zdUHS27fFSLG57bW9S0xrWuLhSvRZw
mCD+//AiJX864dJ/mjHn7Wc55GFaxgMvbALcxT+hCIeDCWYnRqh/fpKNj+BxvVoN
UrcCAwEAAaAAAMAOGCSqGSIb3DQEBBQUAA4GBAAVazWOAtftfU9dyFgTxOY01D/zO
FOTkbnDQOG18e4ftJ3rROD1TvIIMjg3K8zsAS8Gd3pME1ejQLYoBrtasqdcUqG1X
50bLG1subWsXr88PngaBwjYoTpG3q1zvUPJZLAVmdL3ne5urTbABX08cCHOQGtH+
PX9dw40JWkIC8QhV
-----END CERTIFICATE REQUEST-----
```

- Copy the contents of the Certificate request (in PEM format). Use the contents to apply for a 3rd-party certification authority such as Symantec VeriSign. Wait for the certificate authority to issue an SSL certificate; click Browse to search for the issued certificate, and then click Upload to finish the process.

The screenshot shows the Symantec VeriSign Trust Center interface. At the top, it says "Now from Symantec" and "VeriSign Trust Center". Below this, there is a navigation bar with "Free Trial" and steps: "1) Options", "2) Technical Contact", "3) CSR", and "4) Summary".

The main section is titled "Enter Certificate Signing Request (CSR)". It contains a "Server platform:" dropdown menu with a "Select one" button. To the right, there is a "Sample CSR" text area containing a PEM format certificate request. Below this, there is a "Paste Certificate Signing Request (CSR):" text area with a large empty box for pasting the request.

At the bottom of the interface, there is a "Total: US \$0 (Free Trial)" label and three buttons: "< Back", "Cancel", and "Continue".

**NOTE:**

- How do I cancel the HTTPS settings?  
1. Click on the **Remove certificate** button.

Certificate:

Certificate information	
Status:	Invalid public key
method:	Create certificate request and install
Country:	TW
State or province:	Asia
Locality:	Asia
Organization:	VIVOTEK.Inc
Organization unit:	VIVOTEK.Inc
Common name:	www.vivotek.com

2. If you are currently running a secure connection The webpage will redirect to a non-HTTPS page automatically.

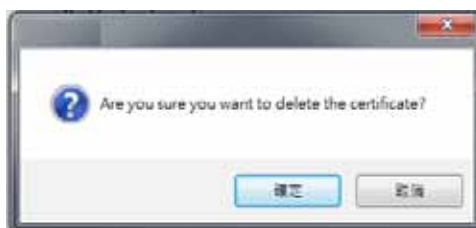
**Enable HTTPS**

Check this item to enable HTTPS communication, then select a connection option: "HTTP & HTTPS" or "HTTPS only". Note that you have to create and install a certificate first before clicking the **Save** button.

**Enable HTTPS**

Enable HTTPS secure connection:

HTTP & HTTPS  HTTPS only

## Security > Access List Advanced Mode

This section explains how to control access permission by verifying the client PC's IP address.

### General Settings

**General settings**

Maximum number of concurrent streaming:  [View Information](#)

Enable access list filtering

**Maximum number of concurrent streaming connection(s) limited to:** Simultaneous live viewing for 1~10 clients (including stream 1 and stream 2). The default value is 10. If you modify the value and click **Save**, all current connections will be disconnected and automatically attempt to re-link (IE Explore or Quick Time Player).

**View Information:** Click this button to display the connection status window showing a list of the current connections. For example:

	IP address	Elapsed time	User ID
<input type="checkbox"/>	172.16.2.53	00:00:05	
<input type="checkbox"/>	192.168.4.104	01:49:35	

Note that only consoles that are currently displaying live streaming will be listed in the View Information list.

- IP address: Current connections to the Network Camera.
- Elapsed time: How much time the client has been at the webpage.
- User ID: If the administrator has set a password for the webpage, the clients have to enter a user name and password to access the live video. The user name will be displayed in the User ID column. If the administrator allows clients to link to the webpage without a user name and password, the User ID column will be empty.

There are some situations that allow clients access to the live video without a user name and password:

1. The administrator does not set up a root password. For more information about how to set up a root password and manage user accounts, please refer to Security > User account on page 75.
2. The administrator has set up a root password, but set **RTSP Authentication** to "disable". For more information about **RTSP Authentication**, please refer to RTSP Streaming on page 66.
3. The administrator has set up a root password, but allows anonymous viewing. For more information about **Allow Anonymous Viewing**, please refer to page 75.

- **Refresh:** Click this button to refresh all current connections.
- **Add to deny list:** You can select entries from the Connection Status list and add them to the Deny List to deny access. Please note that those checked connections will only be disconnected temporarily and will automatically try to re-link again (IE Explore or Quick Time Player). If you want to enable the denied list, please check **Enable access list filtering** and click **Save** in the first column.
- **Disconnect:** If you want to break off the current connections, please select them and click this button. Please note that those checked connections will only be disconnected temporarily and will automatically try to re-link again (IE Explore or Quick Time Player).

**Enable access list filtering:** Check this item and click **Save** if you want to enable the access list filtering function.

## Filter

**Filter type:** Select **Allow** or **Deny** as the filter type. If you choose **Allow Type**, only those clients whose IP addresses are on the Access List below can access the Network Camera, and the others cannot access. On the contrary, if you choose **Deny Type**, those clients whose IP addresses are on the Access List below will not be allowed to access the Network Camera, and the others can access.

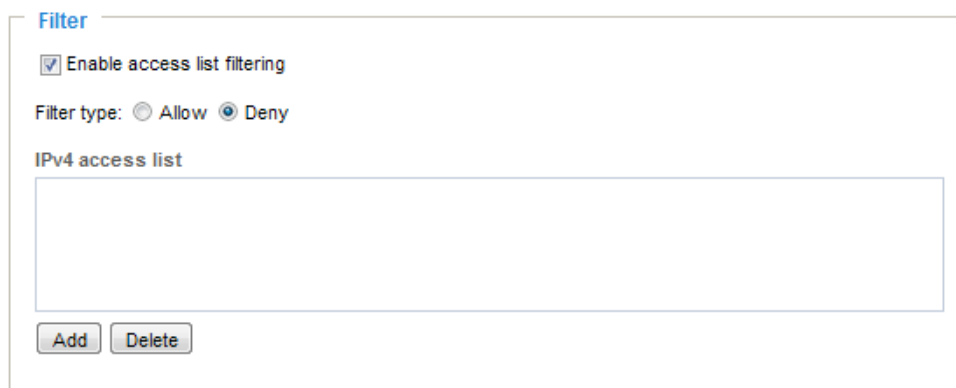

The screenshot shows a configuration window titled "Filter". It contains the following elements:

- A checked checkbox labeled "Enable access list filtering".
- A "Filter type:" label with two radio buttons: "Allow" (unselected) and "Deny" (selected).
- A label "IPv4 access list" above a large, empty rectangular text input field.
- At the bottom of the input field, there are two buttons: "Add" and "Delete".

Then you can **Add** a rule to the following Access List. Please note that the IPv6 access list column will not be displayed unless you enable IPv6 on the Network page. For more information about **IPv6 Settings**, please refer to Network > General settings on page 57 for detailed information.

There are three types of rules:

**Single:** This rule allows the user to add an IP address to the Allowed/Denied list.  
For example:

**Filter address**

Rule:

IP address:

**Network:** This rule allows the user to assign a network address and corresponding subnet mask to the Allow/Deny List. The address and network mask are written in CIDR format.  
For example:

**Filter address**

Rule:

Network address / Network mask:  /

IP address 192.168.2.x will be blocked.

**Range:** This rule allows the user to assign a range of IP addresses to the Allow/Deny List.  
Note: This rule is only applied to IPv4.  
For example:

**Filter address**

Rule:

IP address - IP address:  -

**Administrator IP address**

**Always allow the IP address to access this device:** You can check this item and add the Administrator’s IP address in this field to make sure the Administrator can always connect to the device.

**Administrator IP address**

Always allow the IP address to access this device

## Security > IEEE 802.1X Advanced Mode

Enable this function if your network environment uses IEEE 802.1x, which is a port-based network access control. The network devices, intermediary switch/access point/hub, and RADIUS server must support and enable 802.1x settings.

The 802.1x standard is designed to enhance the security of local area networks, which provides authentication to network devices (clients) attached to a network port (wired or wireless). If all certificates between client and server are verified, a point-to-point connection will be enabled; if authentication fails, access on that port will be prohibited. 802.1x utilizes an existing protocol, the Extensible Authentication Protocol (EAP), to facilitate communication.

- The components of a protected network with 802.1x authentication:



1. Supplicant: A client end user (camera), which requests authentication.
2. Authenticator (an access point or a switch): A “go between” which restricts unauthorized end users from communicating with the authentication server.
3. Authentication server (usually a RADIUS server): Checks the client certificate and decides whether to accept the end user’s access request.

- VIVOTEK Network Cameras support two types of EAP methods to perform authentication: **EAP-PEAP** and **EAP-TLS**.

Please follow the steps below to enable 802.1x settings:

1. Before connecting the Network Camera to the protected network with 802.1x, please apply a digital certificate from a Certificate Authority (i.e., your network administrator) which can be validated by a RADIUS server.
2. Connect the Network Camera to a PC or notebook outside of the protected LAN. Open the configuration page of the Network Camera as shown below. Select **EAP-PEAP** or **EAP-TLS** as the EAP method. In the following blanks, enter your ID and password issued by the CA, then upload related certificate(s).

**IEEE 802.1x**

Enable IEEE 802.1x

EAP method: EAP-PEAP ▼

Identity:

Password:

CA certificate:

Status: no file

**IEEE 802.1x**

Enable 802.1x

EAP method: EAP-TLS

Identity:

Private key password:

CA certificate:

Status: no file

client certificate:

Status: no file

Client private key:

Status: no file

3. When all settings are complete, move the Network Camera to the protected LAN by connecting it to an 802.1x enabled switch. The devices will then start the authentication automatically.

 **NOTE:**

► *The authentication process for 802.1x:*

1. *The Certificate Authority (CA) provides the required signed certificates to the Network Camera (the supplicant) and the RADIUS Server (the authentication server).*
2. *A Network Camera requests access to the protected LAN using 802.1X via a switch (the authenticator). The client offers its identity and client certificate, which is then forwarded by the switch to the RADIUS Server, which uses an algorithm to authenticate the Network Camera and returns an acceptance or rejection back to the switch.*
3. *The switch also forwards the RADIUS Server's certificate to the Network Camera.*
4. *Assuming all certificates are validated, the switch then changes the Network Camera's state to authorized and is allowed access to the protected network via a pre-configured port.*

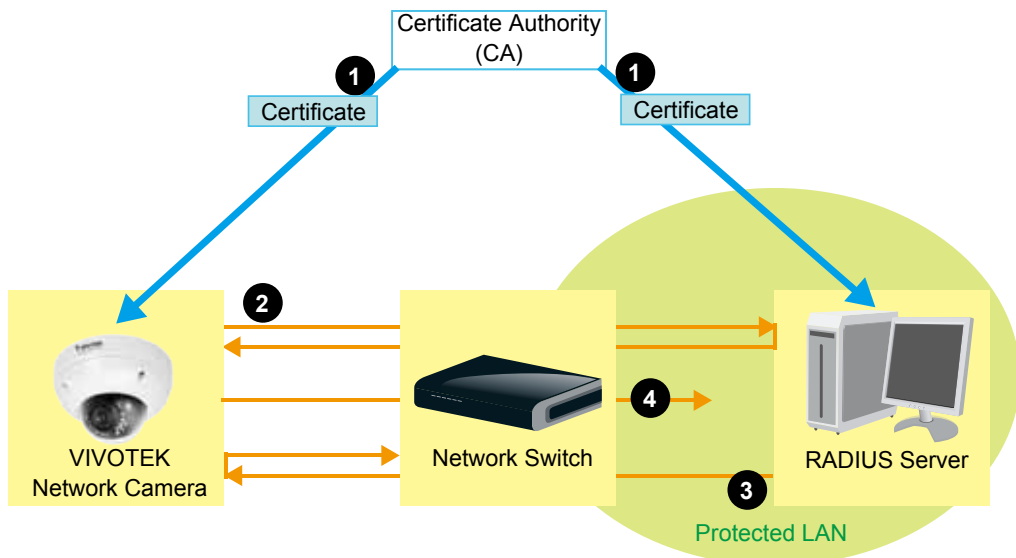



## Network > General settings

This section explains how to configure a wired network connection for the Network Camera.

### Network Type

### LAN

Select this option when the Network Camera is deployed on a local area network (LAN) and is intended to be accessed by local computers. The default setting for the Network Type is LAN. Remember to click **Save** when you complete the Network setting.

**Get IP address automatically:** Select this option to obtain an available dynamic IP address assigned by the DHCP server each time the camera is connected to the LAN.

**Use fixed IP address:** Select this option to manually assign a static IP address to the Network Camera.

1. You can make use of VIVOTEK Installation Wizard 2 on the software CD to easily set up the Network Camera on LAN. Please refer to Software Installation on page 18 for details.
2. Enter the Static IP, Subnet mask, Default router, and Primary DNS provided by your ISP.

**Subnet mask:** This is used to determine if the destination is in the same subnet. The default value is "255.255.255.0".

**Default router:** This is the gateway used to forward frames to destinations in a different subnet. Invalid router setting will fail the transmission to destinations in different subnet.

**Primary DNS:** The primary domain name server that translates hostnames into IP addresses.

**Secondary DNS:** Secondary domain name server that backups the Primary DNS.

**Primary WINS server:** The primary WINS server that maintains the database of computer names and IP addresses.

**Secondary WINS server:** The secondary WINS server that maintains the database of computer names and IP addresses.

**Enable UPnP presentation:** Select this option to enable UPnP™ presentation for your Network Camera so that whenever a Network Camera is presented to the LAN, shortcuts of connected Network Cameras will be listed in My Network Places. You can click the shortcut to link to the web browser. Currently, UPnP™ is supported by Windows XP or later. Note that to utilize this feature, please make sure the UPnP™ component is installed on your computer.

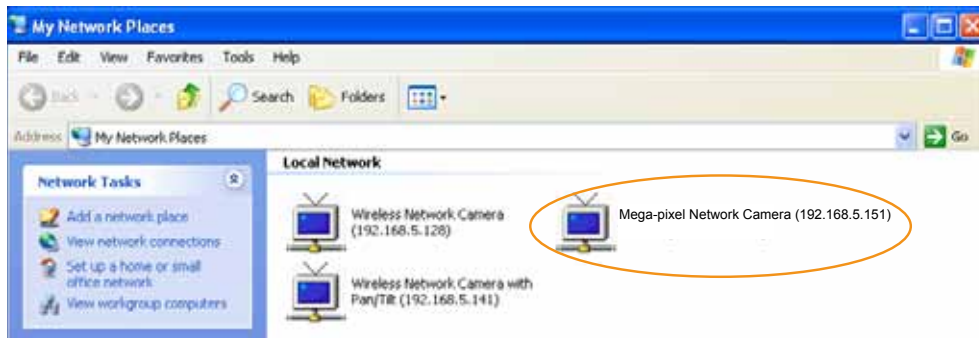

**Enable UPnP port forwarding:** To access the Network Camera from the Internet, select this option to allow the Network Camera to open ports on the router automatically so that video streams can be sent out from a LAN. To utilize of this feature, make sure that your router supports UPnP™ and it is activated.

### PPPoE (Point-to-point over Ethernet)

Select this option to configure your Network Camera to make it accessible from anywhere as long as there is an Internet connection. Note that to utilize this feature, it requires an account provided by your ISP.

Follow the steps below to acquire your Network Camera's public IP address.

1. Set up the Network Camera on the LAN.
2. Go to Configuration > Event > Event settings > Add server (please refer to Add server on page 95) to add a new email or FTP server.
3. Go to CConfiguration > Event > Event settings > Add media (please refer to Add media on page 100). Select System log so that you will receive the system log in TXT file format which contains the Network Camera's public IP address in your email or on the FTP server.
4. Go to Configuration > Network > General settings > Network type. Select PPPoE and enter the user name and password provided by your ISP. Click **Save** to enable the setting.

**Network type**

LAN

PPPoE

User name:

Password:

Confirm password:

Enable IPv6

5. The Network Camera will reboot.

6. Disconnect the power to the Network Camera; remove it from the LAN environment.

 **NOTE:**

- ▶ If the default ports are already used by other devices connected to the same router, the Network Camera will select other ports for the Network Camera.
- ▶ If UPnP™ is not supported by your router, you will see the following message:  
**Error: Router does not support UPnP port forwarding.**
- ▶ Steps to enable the UPnP™ user interface on your computer:  
Note that you must log on to the computer as a system administrator to install the UPnP™ components.

1. Go to Start, click **Control Panel**, then click **Add or Remove Programs**.

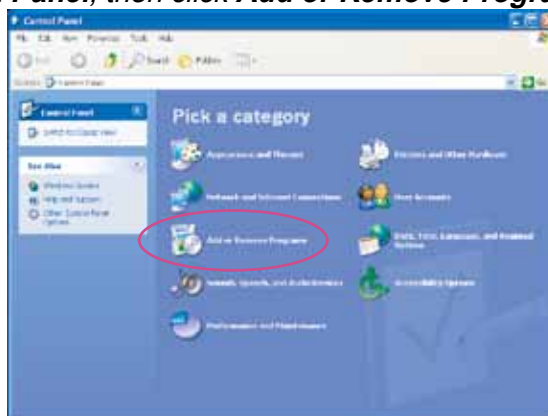

2. In the Add or Remove Programs dialog box, click **Add/Remove Windows Components**.

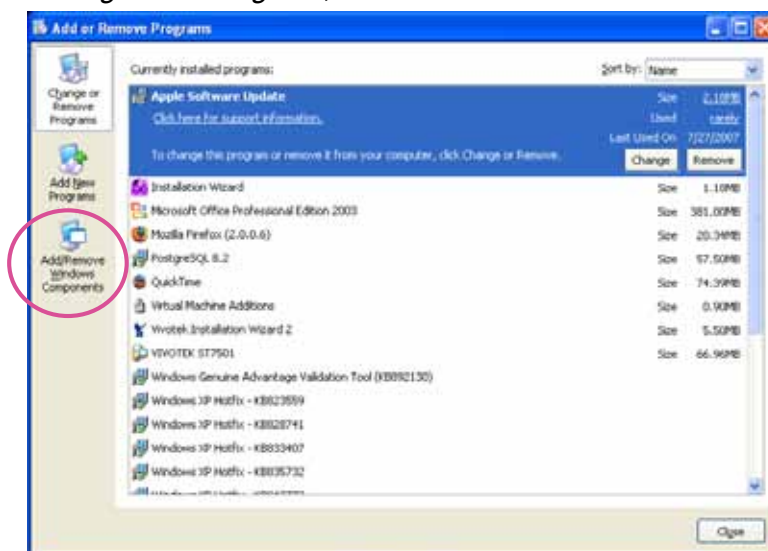

3. In the Windows Components Wizard dialog box, select **Networking Services** and click **Details**.

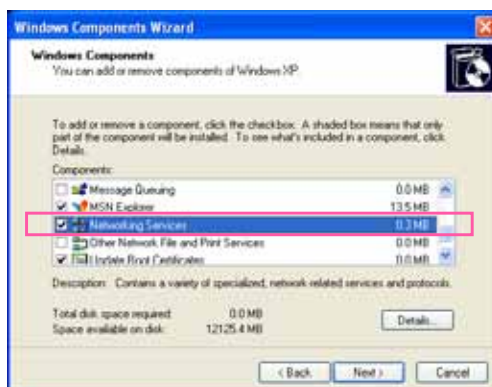

4. In the Networking Services dialog box, select **Universal Plug and Play** and click **OK**.

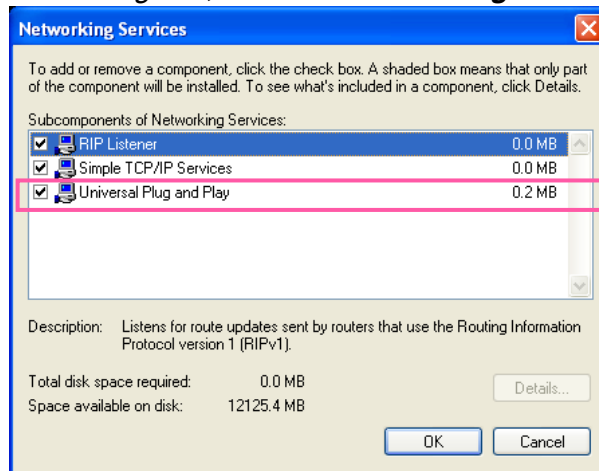

5. Click **Next** in the following window.

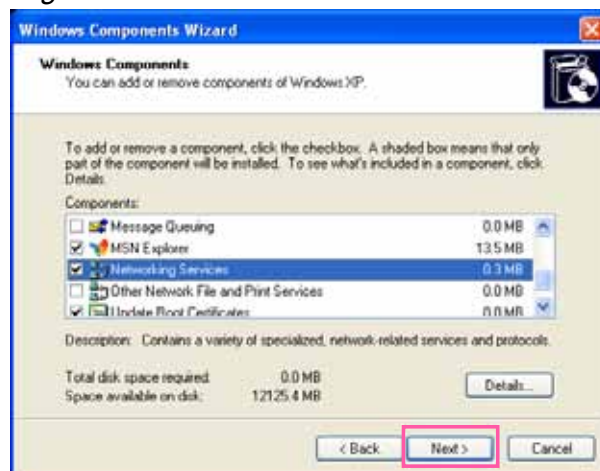

6. Click **Finish**. UPnP™ is enabled.

► How does UPnP™ work?

UPnP™ networking technology provides automatic IP configuration and dynamic discovery of devices added to a network. Services and capabilities offered by networked devices, such as printing and file sharing, are available among each other without the need for cumbersome network configuration. In the case of Network Cameras, you will see Network Camera shortcuts under My Network Places.

► Enabling UPnP port forwarding allows the Network Camera to open a secondary HTTP port on the router-not HTTP port-meaning that you have to add the secondary HTTP port number to the Network Camera's public address in order to access the Network Camera from the Internet. For example, when the HTTP port is set to 80 and the secondary HTTP port is set to 8080, refer to the list below for the Network Camera's IP address.

From the Internet	In LAN
http://203.67.124.123:8080	http://192.168.4.160 or http://192.168.4.160:8080

► If the PPPoE settings are incorrectly configured or the Internet access is not working, restore the Network Camera to factory default; please refer to Restore on page 43 for details. After the Network Camera is reset to factory default, it will be accessible on the LAN.

### Enable IPv6

Select this option and click **Save** to enable IPv6 settings.

Please note that this only works if your network environment and hardware equipment support IPv6. The browser should be Microsoft® Internet Explorer 6.5, Mozilla Firefox 3.0 or above.

**Network type**

LAN

PPPoE

User name:

Password:

Confirm password:

Enable IPv6

[IPv6 information](#)

Manually setup the IP address

When IPv6 is enabled, by default, the network camera will listen to router advertisements and be assigned with a link-local IPv6 address accordingly.

IPv6 Information: Click this button to obtain the IPv6 information as shown below.

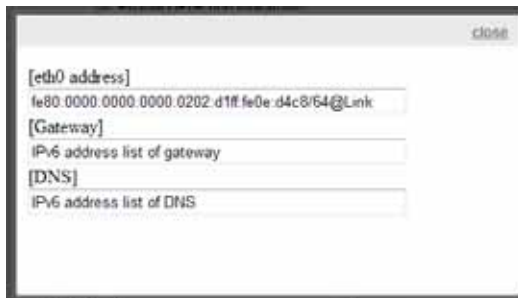

If your IPv6 settings are successful, the IPv6 address list will be listed in the pop-up window. The IPv6 address will be displayed as follows:

### Refers to Ethernet

[eth0 address]	
2001:0c08:2500:0002:0202:d1ff:fe04:65f4/64@Global	— Link-global IPv6 address/network mask
fe80:0000:0000:0000:0202:d1ff:fe04:65f4/64@Link	— Link-local IPv6 address/network mask
[Gateway]	
fe80::211:d8ff:fea2:1a2b	
[DNS]	
2010:05c0:978d::	



Enable IPv6

**IPv6 information**

Manually setup the IP address

Optional IP address / Prefix length  / 64

Optional default router

Optional primary DNS

**Port**

port	
HTTPS port:	<input type="text" value="443"/>
Two way audio port:	<input type="text" value="5060"/>
FTP port:	<input type="text" value="21"/>

**HTTPS port:** By default, the HTTPS port is set to 443. It can also be assigned to another port number between 1025 and 65535.

**Two way audio port:** By default, the two way audio port is set to 5060. Also, it can also be assigned to another port number between 1025 and 65535.





The Network Camera supports two way audio communication so that operators can transmit and receive audio simultaneously. By using the Network Camera’s built-in or external microphone and an external speaker, you can communicate with people around the Network Camera.

Note that as JPEG only transmits a series of JPEG images to the client, to enable the two-way audio function, make sure the video mode is set to “MPEG-4” on the Media > Video > Stream settings page and the media option is set to “Media > Video > Stream settings” on the Client Settings page. Please refer to Client Settings on page 32 and Stream settings on page 84.



Audio is being transmitted to the Network Camera



Click  to enable audio transmission to the Network Camera; click  to adjust the volume of microphone; click  to turn off the audio. To stop talking, click  again.

**FTP port:** The FTP server allows the user to save recorded video clips. You can utilize VIVOTEK's Installation Wizard 2 to upgrade the firmware via FTP server. By default, the FTP port is set to 21. It also can be assigned to another port number between 1025 and 65535.



## Network > Streaming protocols Advanced Mode

### HTTP streaming

To utilize HTTP authentication, make sure that you have set a password for the Network Camera first; please refer to Security > User account on page 75 for details.

HTTP streaming	RTSP streaming
Authentication:	basic ▾
HTTP port:	80
Secondary HTTP port:	8080
Access name for stream 1:	video.mjpg
Access name for stream 2:	video2.mjpg

**Authentication:** Depending on your network security requirements, the Network Camera provides two types of security settings for an HTTP transaction: basic and digest.

If **basic** authentication is selected, the password is sent in plain text format and there can be potential risks of being intercepted. If **digest** authentication is selected, user credentials are encrypted using MD5 algorithm and thus provide better protection against unauthorized accesses.

**HTTP port / Secondary HTTP port:** By default, the HTTP port is set to 80 and the secondary HTTP port is set to 8080. They can also be assigned to another port number between 1025 and 65535. If the ports are incorrectly assigned, the following warning messages will be displayed:

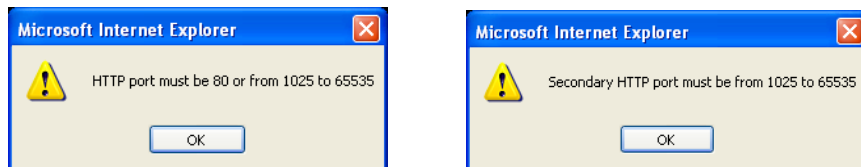

To access the Network Camera on the LAN, both the HTTP port and secondary HTTP port can be used to access the Network Camera. For example, when the HTTP port is set to 80 and the secondary HTTP port is set to 8080, refer to the list below for the Network Camera's IP address.

On the LAN
http://192.168.4.160 or http://192.168.4.160:8080

**Access name for stream 1 & 2:** This Network camera supports multiple streams simultaneously. The access name is used to differentiate the streaming source. Users can click **Media > Video > Stream settings** to set up the video quality of linked streams. For more information about how to set up the video quality, please refer to Stream settings on page 84.

When using **Mozilla Firefox** or **Netscape** to access the Network Camera and the video mode is set to JPEG, users will receive video comprised of continuous JPEG images. This technology, known as "server push", allows the Network Camera to feed live pictures to Mozilla Firefox and Netscape.

URL command -- [http://<ip address>:<http port>/<access name for stream 1 or 2>](#)

For example, when the Access name for [stream 2](#) is set to [video2.mjpg](#):

1. Launch Mozilla Firefox or Netscape.
2. Type the above URL command in the address bar. Press **Enter**.
3. The JPEG images will be displayed in your web browser.



**NOTE:**

- ▶ Microsoft® Internet Explorer **does not** support server push technology; therefore, using [http://<ip address>:<http port>/<access name for stream 1 or 2>](#) will fail to access the Network Camera.
- ▶ Users can only use URL commands to request the stream 5. For more information about URL commands, please refer to page 118.

**RTSP Streaming**

To utilize RTSP streaming authentication, make sure that you have set a password for the Network Camera first; please refer to Security > User account on page 75 for details.

HTTP streaming	RTSP streaming
Authentication:	disable ▾
Access name for stream 1:	live.sdp
Access name for stream 2:	live2.sdp
RTSP port:	554
RTP port for video:	5556
RTCP port for video:	5557
RTP port for audio:	5558
RTCP port for audio:	5559
<ul style="list-style-type: none"> <li>✦ Multicast settings for stream 1</li> <li>✦ Multicast settings for stream 2</li> </ul>	

**Authentication:** Depending on your network security requirements, the Network Camera provides three types of security settings for streaming via RTSP protocol: disable, basic, and digest.

If **basic** authentication is selected, the password is sent in plain text format, but there can be potential risks of it being intercepted. If **digest** authentication is selected, user credentials are encrypted using MD5 algorithm, thus providing better protection against unauthorized access.

The availability of the RTSP streaming for the three authentication modes is listed in the following table:

	Quick Time player	Real Player
Disable	O	O
Basic	O	O
Digest	O	X

**Access name for stream 1 & 2:** This Network camera supports multiple streams simultaneously. The access name is used to differentiate the streaming source.

If you want to use an **RTSP player** to access the Network Camera, you have to set the video mode to **H.264 / MPEG-4** and use the following RTSP URL command to request transmission of the streaming data.

`rtsp://<ip address>:<rtsp port>/<access name for stream1 or 2>`

For example, when the access name for **stream 1** is set to **live.sdp**:

1. Launch an RTSP player.
2. Choose File > Open URL. A URL dialog box will pop up.
3. Type the above URL command in the text box.
4. The live video will be displayed in your player as shown below.

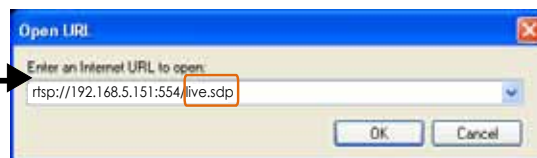

**RTSP port /RTP port for video, audio/ RTCP port for video, audio**

- RTSP (Real-Time Streaming Protocol) controls the delivery of streaming media. By default, the port number is set to 554.
- The RTP (Real-time Transport Protocol) is used to deliver video and audio data to the clients. By default, the RTP port for video is set to 5556 and the RTP port for audio is set to 5558.
- The RTCP (Real-time Transport Control Protocol) allows the Network Camera to transmit the data by monitoring the Internet traffic volume. By default, the RTCP port for video is set to 5557 and the RTCP port for audio is set to 5559.

The ports can be changed to values between 1025 and 65535. The RTP port must be an even number and the RTCP port is the RTP port number plus one, and thus is always an odd number. When the RTP port changes, the RTCP port will change accordingly.

If the RTP ports are incorrectly assigned, the following warning message will be displayed:

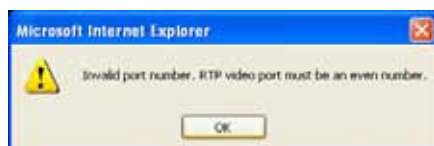

**Multicast settings for stream 1 & 2:** Click the items to display the detailed configuration information. Select the Always multicast option to enable multicast for stream 1 or 2.

Multicast settings for stream 1:
   
 Always multicast
   
 Multicast group address: 
  
 Multicast video port: 
  
 Multicast RTCP video port: 
  
 Multicast audio port: 
  
 Multicast RTCP audio port: 
  
 Multicast TTL [1~255]:

Multicast settings for stream 2:
   
 Always multicast
   
 Multicast group address: 
  
 Multicast video port: 
  
 Multicast RTCP video port: 
  
 Multicast audio port: 
  
 Multicast RTCP audio port: 
  
 Multicast TTL [1~255]:

Unicast video transmission delivers a stream through point-to-point transmission; multicast, on the other hand, sends a stream to the multicast group address and allows multiple clients to acquire the stream at the same time by requesting a copy from the multicast group address. Therefore, enabling multicast can effectively save Internet bandwidth.

The ports can be changed to values between 1025 and 65535. The multicast RTP port must be an even number and the multicast RTCP port number is the multicast RTP port number plus one, and thus is always odd. When the multicast RTP port changes, the multicast RTCP port will change accordingly.

If the multicast RTP video ports are incorrectly assigned, the following warning message will be displayed:

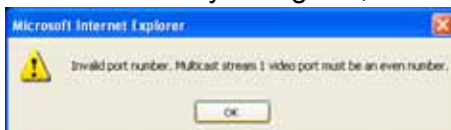

**Multicast TTL [1~255]:** The multicast TTL (Time To Live) is the value that tells the router the range a packet can be forwarded.

## Network > DDNS

This section explains how to configure the dynamic domain name service for the Network Camera. DDNS is a service that allows your Network Camera, especially when assigned with a dynamic IP address, to have a fixed host and domain name.

### Express link

Express Link is a free service provided by VIVOTEK server, which allows users to register a domain name for a network device. One URL can only be mapped to one MAC address. This service will check out if the host name is valid and automatically open a port on your router. Unlike DDNS, the user has to manually check out UPnP port forwarding, Express Link is more convenient and easy to set up.

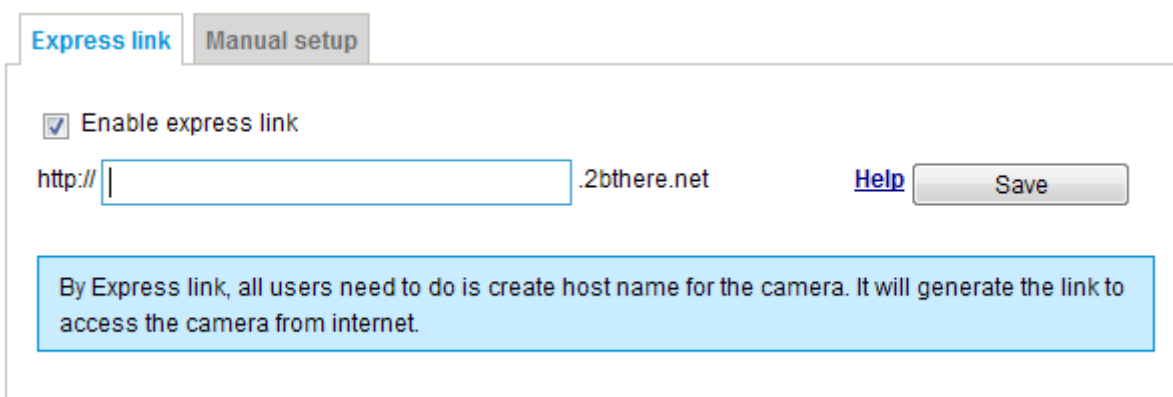

Express link   Manual setup

Enable express link

http://  .2bthere.net   [Help](#)  

By Express link, all users need to do is create host name for the camera. It will generate the link to access the camera from internet.

Please follow the steps below to enable Express Link:

1. Make sure that your router supports UPnP port forwarding and it is activated.
2. Check **Enable express link**.
3. Enter a host name for the network device and click **Save**. If the host name has been used by another device, a warning message will show up. If the host name is valid, it will show a message as shown below.



Express link   Manual setup

Enable express link

http:// 0002D1123456 .2bthere.net   [Help](#)  

The camera can now be accessed at <http://0002D1123456.2bthere.net>

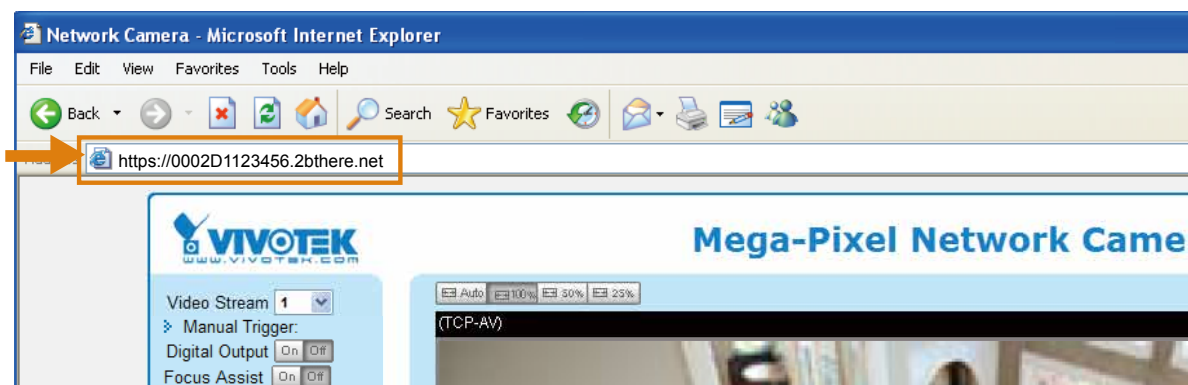

## Manual setup

### DDNS: Dynamic domain name service

**DDNS: Dynamic domain name service**

Enable DDNS:

Provider: Dyndns.org(Dynamic) ▼

Host name:

User name:

Password:

**Enable DDNS:** Select this option to enable the DDNS setting.

**Provider:** Select a DDNS provider from the provider drop-down list.

VIVOTEK offers **Safe100.net**, a free dynamic domain name service, to VIVOTEK customers. It is recommended that you register **Safe100.net** to access VIVOTEK's Network Cameras from the Internet. Additionally, we offer other DDNS providers, such as Dyndns.org(Dynamic), Dyndns.org(Custom), TZO.com, DHS.org, CustomSafe100, dyn-interfree.it.

Note that before utilizing this function, please apply for a dynamic domain account first.

#### ■ Safe100.net

1. In the DDNS column, select **Safe100.net** from the drop-down list. Click **I accept** after reviewing the terms of the Service Agreement.
2. In the Register column, fill in the Host name (xxxx.safe100.net), Email, Key, and Confirm Key, and click **Register**. After a host name has been successfully created, a success message will be displayed in the DDNS Registration Result column.

**Register**

Host name: WTK.safe100.net

Email: wtk@vivotek.com

Key: •••• Forget key

Confirm key: ••••

To apply for a domain name for the camera, or to modify the previously registered information, fill in the following fields and then click "Register".

Register

DDNS Registration Result:

[Register] Successfully Your account information has been mailed to registered e-mail address

Upon successful registration, you can click copy to automatically upload relevant information to the DDNS form or you can manually fill it in. Then, click "Save" to save new settings.

3. Click **Copy** and all the registered information will automatically be uploaded to the corresponding fields in the DDNS column at the top of the page as seen in the picture.

**DDNS: Dynamic domain name service**

Enable DDNS:

Provider:

Host name:  [\*safe100.net]

Email:

Key:

---

**Register**

Host name:

Email:

Key:

Confirm key:

To apply for a domain name for the camera, or to modify the previously registered information, fill in the following fields and then click "Register".

DDNS Registration Result:

Upon successful registration, you can click [copy](#) to automatically upload relevant information to the DDNS form or you can manually fill it in. Then, click "Save" to save new settings.

4. Select Enable DDNS and click **Save** to enable the setting.

#### ■ CustomSafe100

VIVOTEK offers documents to establish a CustomSafe100 DDNS server for distributors and system integrators. You can use CustomSafe100 to register a dynamic domain name if your distributor or system integrators offer such services.

1. In the DDNS column, select CustomSafe100 from the drop-down list.
2. In the Register column, fill in the Host name, Email, Key, and Confirm Key; then click **Register**. After a host name has been successfully created, you will see a success message in the DDNS Registration Result column.
3. Click **Copy** and all for the registered information will be uploaded to the corresponding fields in the DDNS column.
4. Select Enable DDNS and click **Save** to enable the setting.

**Forget key:** Click this button if you have forgotten the key to Safe100.net or CustomSafe100. Your account information will be sent to your email address.

Refer to the following links to apply for a dynamic domain account when selecting other DDNS providers:

- [Dyndns.org\(Dynamic\) / Dyndns.org\(Custom\)](http://www.dyndns.com/): visit <http://www.dyndns.com/>
- [TZO.com](http://www.tzo.com/): visit <http://www.tzo.com/>
- [DHS.org](http://www.dhs.org/): visit <http://www.dhs.org/>
- [dyn-interfree.it](http://dyn-interfree.it/): visit <http://dyn-interfree.it/>

## Network > QoS (Quality of Service) Advanced Mode

Quality of Service refers to a resource reservation control mechanism, which guarantees a certain quality to different services on the network. Quality of service guarantees are important if the network capacity is insufficient, especially for real-time streaming multimedia applications. Quality can be defined as, for instance, a maintained level of bit rate, low latency, no packet dropping, etc.

The following are the main benefits of a QoS-aware network:

- The ability to prioritize traffic and guarantee a certain level of performance to the data flow.
- The ability to control the amount of bandwidth each application may use, and thus provide higher reliability and stability on the network.

### Requirements for QoS

To utilize QoS in a network environment, the following requirements must be met:

- All network switches and routers in the network must include support for QoS.
- The network video devices used in the network must be QoS-enabled.

### QoS models

#### CoS (the VLAN 802.1p model)

IEEE802.1p defines a QoS model at OSI Layer 2 (Data Link Layer), which is called CoS, Class of Service. It adds a 3-bit value to the VLAN MAC header, which indicates the frame priority level from 0 (lowest) to 7 (highest). The priority is set up on the network switches, which then use different queuing disciplines to forward the packets.

Below is the setting column for CoS. Enter the **VLAN ID** of your switch (0~4095) and choose the priority for each application (0~7).

**CoS**

Enable CoS

VLAN ID:	<input style="width: 60px;" type="text" value="1"/>
Live video:	<input style="width: 60px;" type="text" value="0"/> ▼
Live audio:	<input style="width: 60px;" type="text" value="0"/> ▼
Event/Alarm:	<input style="width: 60px;" type="text" value="0"/> ▼
Management:	<input style="width: 60px;" type="text" value="0"/> ▼

If you assign Video the highest level, the switch will handle video packets first.



#### NOTE:

- ▶ A VLAN Switch (802.1p) is required. The web browsing may fail if the CoS setting is incorrect.
- ▶ Class of Service technologies do not guarantee a level of service in terms of bandwidth and delivery time; they offer a "best-effort." Users can think of CoS as "coarsely-grained" traffic control and QoS as "finely-grained" traffic control.
- ▶ Although CoS is simple to manage, it lacks scalability and does not offer end-to-end guarantees since it is based on L2 protocol.



### QoS/DSCP (the DiffServ model)

DSCP-ECN defines QoS at Layer 3 (Network Layer). The Differentiated Services (DiffServ) model is based on packet marking and router queuing disciplines. The marking is done by adding a field to the IP header, called the DSCP (Differentiated Services Codepoint). This is a 6-bit field that provides 64 different class IDs. It gives an indication of how a given packet is to be forwarded, known as the Per Hop Behavior (PHB). The PHB describes a particular service level in terms of bandwidth, queueing theory, and dropping (discarding the packet) decisions. Routers at each network node classify packets according to their DSCP value and give them a particular forwarding treatment; for example, how much bandwidth to reserve for it.

Below are the setting options of DSCP (DiffServ Codepoint). Specify the DSCP value for each application (0~63).

#### QoS/DSCP

Enable QoS/DSCP

Live video:	<input type="text" value="0"/>
Live audio:	<input type="text" value="0"/>
Event/Alarm:	<input type="text" value="0"/>
Management:	<input type="text" value="0"/>

## Network > SNMP (Simple Network Management Protocol) Advanced Mode

This section explains how to use the SNMP on the network camera. The Simple Network Management Protocol is an application layer protocol that facilitates the exchange of management information between network devices. It helps network administrators to remotely manage network devices and find, solve network problems with ease.

■ The SNMP consists of the following three key components:

1. Manager: Network-management station (NMS), a server which executes applications that monitor and control managed devices.
2. Agent: A network-management software module on a managed device which transfers the status of managed devices to the NMS.
3. Managed device: A network node on a managed network. For example: routers, switches, bridges, hubs, computer hosts, printers, IP telephones, network cameras, web server, and database.

Before configuring SNMP settings on the this page, please enable your NMS first.

### SNMP Configuration

#### Enable SNMPv1, SNMPv2c

Select this option and enter the names of Read/Write community and Read Only community according to your NMS settings.

Enable SNMPv1, SNMPv2c

**SNMPv1, SNMPv2c Settings**

Read/Write community:

Read only community:

#### Enable SNMPv3

This option contains cryptographic security, a higher security level, which allows you to set the Authentication password and the Encryption password.

- Security name: According to your NMS settings, choose Read/Write or Read Only and enter the community name.
- Authentication type: Select MD5 or SHA as the authentication method.
- Authentication password: Enter the password for authentication (at least 8 characters).
- Encryption password: Enter a password for encryption (at least 8 characters).

Enable SNMPv3

**SNMPv3 Settings**

Read/Write Security name:

Authentication Type:

Authentication Password:

Encryption Password:

Read only Security name:

Authentication Type:

Authentication Password:

Encryption Password:

## Media > Image Advanced Mode

This section explains how to configure the image settings of the Network Camera. It is composed of the following four columns: General settings, Picture settings, Exposure, and Privacy mask.

### General settings

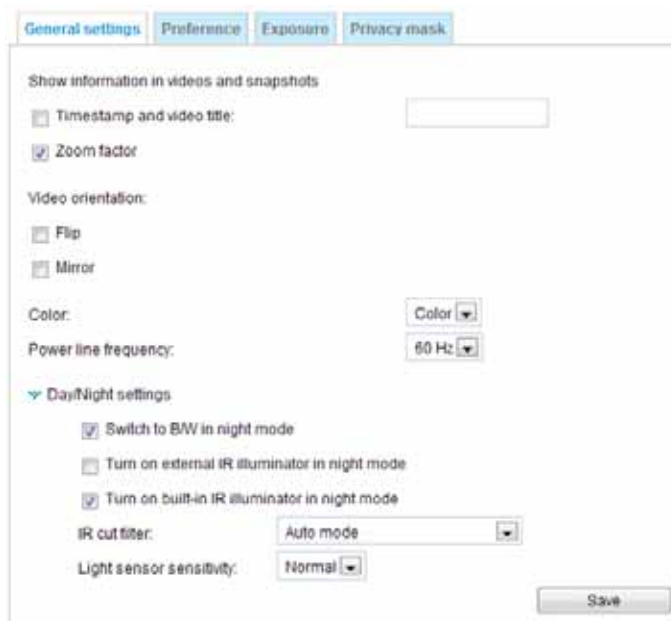

#### Show information in videos and snapshots

**Timestamp and video title:** Enter a name that will be displayed on the title bar of the live video as the picture shown below.

**Zoom factor:** If you check this item, the zoom indicator will be displayed on the Home page when you zoom in/out the live viewing window as the picture shown below. You may zoom in/out the image by scrolling the mouse wheel inside the live viewing window, and the maximum zoom in will be up to 4 times.



**Video orientation:** Flip--vertically reflect the display of the live video; Mirror--horizontally reflect the display of the live video. Select both options if the Network Camera is installed upside-down (ex. on the ceiling) to correct the image orientation. Please note that if you have preset locations, those locations will be cleared after flip/mirror setting.

**Color:** Select to display color or black/white video streams.

**Power line frequency:** Set the power line frequency consistent with local utility settings to eliminate image flickering associated with fluorescent lights. Note that after the power line frequency is changed, you must disconnect and reconnect the power cord of the Network Camera in order for the new setting to take effect.

[Day/Night Settings](#)

## ▼ Day/Night settings

- Switch to B/W in night mode
- Turn on external IR illuminator in night mode
- Turn on built-in IR illuminator in night mode

IR cut filter:

Light sensor sensitivity:

Switch to B/W in night mode

Select this to enable the Network Camera to automatically switch to Black/White during night mode.

Turn on external IR illuminator in night mode

Select this to turn on an external IR illuminator (connected via Digital Output lines) when the camera detects low light condition and enters the night mode.

Turn on built-in IR illuminator in night mode

Select this to turn on the built-in IR illuminators (effective range up to 20 meters) when the camera detects low light condition and enters the night mode.

IR cut filter

With a removable IR-cut filter, this Network Camera can automatically remove the filter to let IR light into the sensor during low light conditions.

## ■ Auto mode

The Network Camera automatically removes the filter by judging the level of ambient light.

## ■ Day mode

In day mode, the Network Camera switches on the IR cut filter at all times to block infrared light from reaching the sensor so that the colors will not be distorted.

## ■ Night mode

In night mode, the Network Camera switches off the IR cut filter at all times for the sensor to accept infrared light, thus helping to improve low light sensitivity.

## ■ Synchronize with digital input (1~3)

The Network Camera automatically removes the IR cut filter when a Digital Input is triggered.

## ■ Schedule mode

The Network Camera switches between day mode and night mode based on a specified schedule. Enter the start and end time for day mode. Note that the time format is [hh:mm] and is expressed in 24-hour clock time. By default, the start and end time of day mode are set to 07:00 and 18:00.

Light sensor sensitivity

Select Low, Normal, or High sensitivity for the light sensor.

## Preference

On this page, you can tune the White balance, Image adjustment and WDR enhanced .

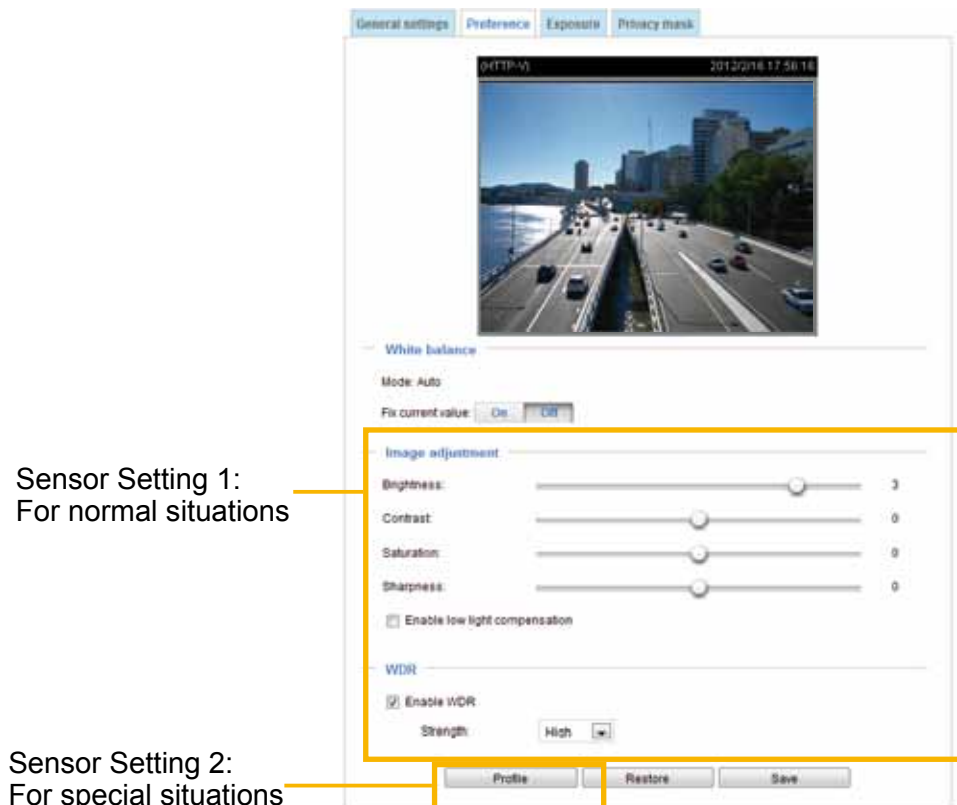

Sensor Setting 1:  
For normal situations

Sensor Setting 2:  
For special situations

White balance: Adjust the value for the best color temperature.

■ You may follow the steps below to adjust the white balance to the best color temperature.

1. Place a sheet of paper of white or cooler-color temperature paper, such as blue, in front of the lens, then allow the Network Camera to automatically adjust the color temperature.
2. Click the **On** button to **Fix current value** and confirm the setting while the white balance is being measured.

### Image Adjustment

- **Brightness**: Adjust the image brightness level, which ranges from -5 to +5.
- **Contrast**: Adjust the image contrast level, which ranges from -5 to +5.
- **Saturation**: Adjust the image saturation level, which ranges from -5 to +5.
- **Sharpness**: Adjust the image sharpness level, which ranges from -3 to +3. You can also select **Customize** and manually enter a value.
- **Enable low light compensation**: Select this option in low light mode, and the values of sharpness and brightness will change automatically as the noise reduction function.

**WDR:** This function allows users to identify more details of objects in the high contrast environment especially for details in the shaded area. You may check **Enable WDR** checkbox, and then adjust the sensitivity (low, high) and the strength (low, medium, high) to reach the best image quality.

**WDR**

Enable WDR

Strength: Medium ▾

Profile
Restore
Save

**NOTE:**

When WDR function is enabled, the Exposure level can not be adjusted.

Note that the **Preview** button has been cancelled, all changes made to image settings is directly shown on screen. You can click **Restore** to recall the original settings without incorporating the changes. When completed with the settings on this page, click **Save** to enable the setting. You can also click on **Profile** to adjust all settings above in a pop-up window for special lighting conditions.

**Activated period**

Enable and apply this profile to

- Day mode
- Night mode
- Schedule mode

**Activated period:** Select the mode this profile to apply to: Day mode, Night mode, or Schedule mode. Please manually enter a range of time if you choose Schedule mode. Then check **Save** to take effect.

## Exposure Advanced Mode

On this page, you can set the Measurement window, Exposure level, Exposure mode, Iris adjustment, Iris speed, Exposure time, and Gain control settings. Detailed configurations will be automatically adjusted since the sensor library will automatically adjust the value according to the ambient light.

Sensor Setting 1:  
For normal situations

**Measurement window**

Full view  Custom

**Exposure control**

Exposure level: 4 ▾

Max gain: 

8x

Iris adjustment: 

MAX
MIN
0

Iris speed: 

Low
High
1

Sensor Setting 2:  
For special situations

Profile
Restore
Save

Measurement Window: This function allows user to set measurement window(s) for low light compensation.

- Full view: Calculate the full range of view and offer appropriate light compensation.
- Custom: This option allows you to manually add a specific window as a measuring area. The measuring window refers to “weighted window” where the lighting condition within the particular area is taken into account. Camera firmware then adopts the weighted averages method to calculate the value.

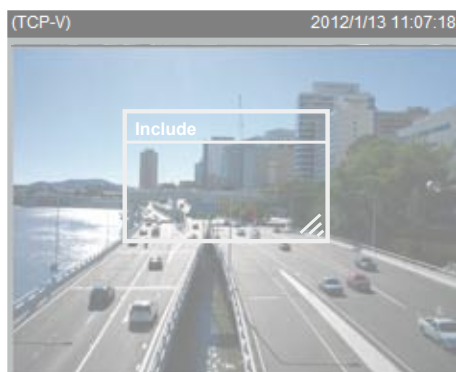

Exposure control:

- Exposure level: You can manually set the Exposure level, which ranges from 0 to 8 (dark to bright). Note that this menu is disabled when the WDR function is enabled.
- Max. Gain: Tune the slider bar to set the Gain Control to the best image quality. Higher gain control value will generate a certain amount of noise.
- Iris Adjustment: The camera comes with a P-iris lens, which controls the iris opening with extreme precision by its built-in stepping motor. Via software controls, the lens maintains the iris opening at an optimal level at all times, resulting in superior sharpness and depth of field as well as image quality.

You can manually tune the value of iris opening (aperture size), which can range from 0 (MAX. short depth of field) to 50 (MIN, long depth of field).

- The smallest number, 0 or MAX, means the iris is open as wide as possible (**largest amount of light received with shortest depth of field**).
- The largest number, 50, means the iris is narrowed down as much as possible (**smallest amount of light received with longest depth of field**).

Once set, the iris will stay at current position as long as the lighting condition allows. When external lighting conditions exceed an acceptable range, the P-iris mechanism adjusts itself.

- Iris speed: The Iris speed slide bar is **for adjusting the opening or closing speed of the iris from 1 (High) to 3 (Low) steps**. You can also adjust the **Gain control** and **Exposure level** according to the ambient light.

You can click **Restore** to recall the original settings without incorporating the changes. When completed with the settings on this page, click **Save** to enable the settings.

If you want to configure another sensor setting for day/night/schedule mode, please click **Profile** to open the Profile of exposure settings page as shown below.

Activated period: Select the mode this profile to apply to: Day mode, Night mode, or Schedule mode. Please manually enter a range of time if you choose Schedule mode. Then check **Save** to take effect.

Please follow the steps below to setup a profile:

1. Check **Enable this profile**.
2. Select the applied mode: Day mode, Night mode, or Schedule mode. Please manually enter a range of time if you choose Schedule mode.
3. Configure Exposure control settings in the following columns. Please refer to previous discussions for detailed information.
4. Click **Save** to enable the setting and click **Close** to exit the page.

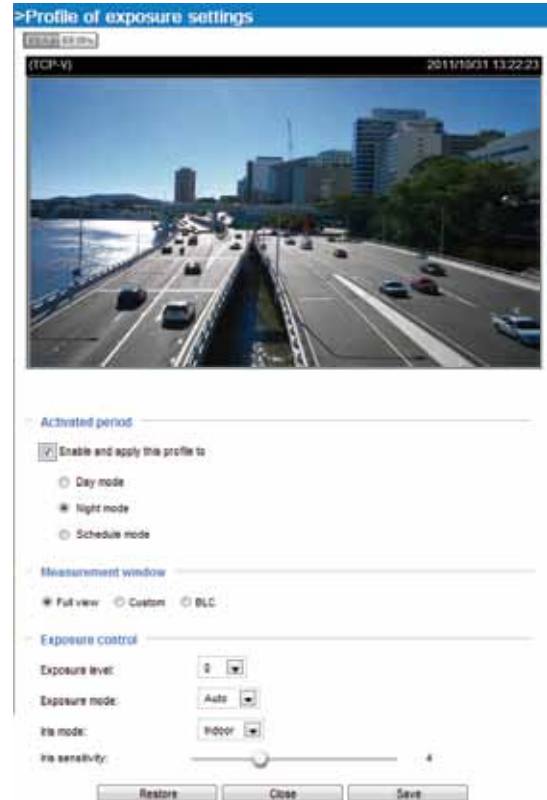



## Privacy mask Advanced Mode

Click **Privacy Mask** to open the settings page. On this page, you can block out sensitive zones to address privacy concerns.



■ To set the privacy mask windows, follow the steps below:

1. Click **New** to add a new window.
2. You can use the mouse cursor to size and drag-drop the window, which is recommended to be at least twice the size of the object (height and width) you want to cover.
3. Enter a Window Name and click **Save** to enable the setting.
4. Click on the **Enable privacy mask** checkbox to enable this function.



### NOTE:

- ▶ *Up to 5 privacy mask windows can be set up on the same screen.*
- ▶ *If you want to delete the privacy mask window, please click the 'x' on the upper right corner of the window.*

## Media > Video Advanced Mode

### Stream settings

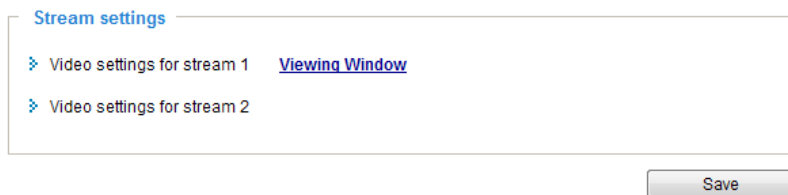

This Network Camera supports multiple streams with frame size ranging from 300 x 200 to 1280 x 800.

The definition of multiple streams:

- Stream 1: Users can define the "Region of Interest" (viewing region) and the "Output Frame Rate" (size of the live view window).
- Stream 2: Stream 2 does not support the "Region of Interest" configuration.

Click **Viewing Window** to open the viewing region settings page. On this page, you can set the **Region of Interest** and the **Output Frame Size** for stream 1 and 2.

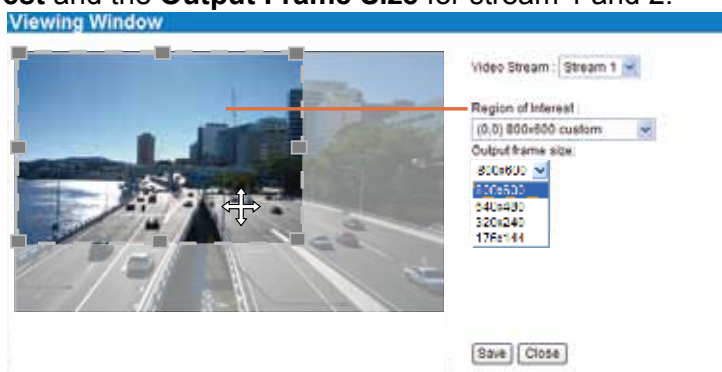

Please follow the steps below to set up those settings for a stream:

1. Select a stream for which you want to set up the viewing region.
2. Select a **Region of Interest** from the drop-down list. The floating frame, the same as the one in the Global View window on the home page, will resize accordingly. If you want to set up a customized viewing region, you can also resize and drag the floating frame to a desired position with your mouse.
3. Choose a proper **Output Frame Size** from the drop-down list according to the size of your monitoring device.

 **NOTE:**

► All the items in the “Region of Interest” should not be larger than the “Output Frame Size” (current maximum resolution).

■ The parameters of the multiple streams:

	Region of Interest	Output frame size
Stream 1	1280 X 800 ~ 176 x 144 (Selectable)	1280 X 800 ~ 176 x 144 (Selectable)
Stream 2	fixed	fixed

When completed with the settings in the Viewing Window, click **Save** to enable the settings and click **Close** to exit the window. The selected **Output Frame Size** will immediately be applied to the **Frame size** of each video stream. Then you can go back to the home page to test the e-PTZ function. For more information about the e-PTZ function, please refer to page 88.

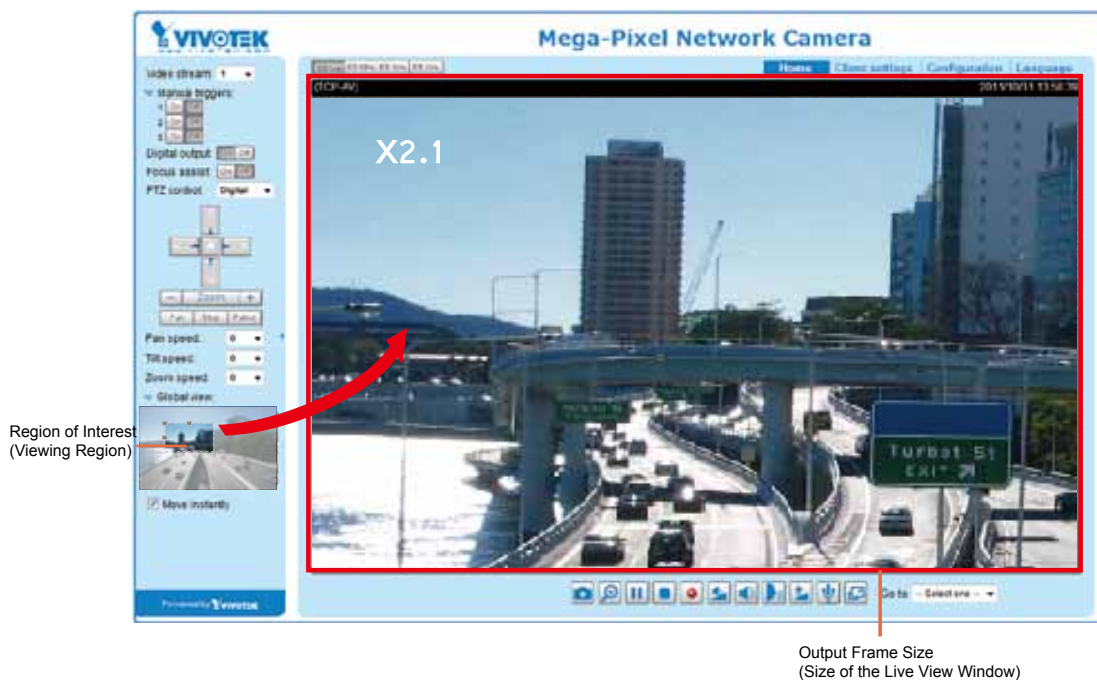

Click the stream item to display the detailed information. The maximum frame size will follow your settings in the above Viewing Window sections.

**Stream settings**

Video settings for stream 1 [Viewing Window](#)

H.264

Frame size: 1280x800

Maximum frame rate: 30 fps

Intra frame period: 1 S

Video quality

Constant bit rate: 4 Mbps

Fixed quality: Customized

26 [0~51]

JPEG

Video settings for stream 2

MPEG-4

H.264

Frame size: 1280x800

Maximum frame rate: 30 fps

Intra frame period: 1 S

Video quality

Constant bit rate: 4 Mbps

Fixed quality: Good

JPEG

This Network Camera offers real-time H.264, MPEG-4 (Stream #2) and MJPEG compression standards (Triple Codec) for real-time viewing. If **H.264 / MPEG-4** mode is selected, the video is streamed via RTSP protocol. There are several parameters for you to adjust the video performance:

Video settings for stream 2 [Viewing Window](#)

MPEG-4

H.264

Frame size: 1280x720

Maximum frame rate: 1 fps

Intra frame period: 1 S

Video quality

Constant bit rate:

■ **Frame size**

You can set up different video resolution for different viewing devices. For example, set a smaller frame size and lower bit rate for remote viewing on mobile phones and a larger video size and a higher bit rate for live viewing on web browsers. Note that a larger frame size takes up more bandwidth.

■ **Maximum frame rate**

This limits the maximum refresh frame rate per second. Set the frame rate higher for smoother video quality and for recognizing moving objects in the field of view.

If the power line frequency is set to 50Hz, the frame rates are selectable at 1fps, 2fps, 3fps, 5fps, 8fps, 10fps, 15fps, 20fps, and 25fps. If the power line frequency is set to 60Hz, the frame rates are selectable at 1fps, 2fps, 3fps, 5fps, 8fps, 10fps, 15fps, 20fps, 25fps, and 30fps. You can also select **Customize** and manually enter a value.

The frame rate will decrease if you select a higher resolution.

■ **Intra frame period**

Determine how often to plant an I frame. The shorter the duration, the more likely you will get better video quality, but at the cost of higher network bandwidth consumption. Select the intra frame period from the following durations: 1/4 second, 1/2 second, 1 second, 2 seconds, 3 seconds, and 4 seconds.

■ **Video quality**

Constant bit rate:

- **Constant bit rate:** A complex scene generally produces a larger file size, meaning that higher bandwidth will be needed for data transmission. The bandwidth utilization is configurable to match a selected level, resulting in mutable video quality performance. The bit rates are selectable at the following rates: 20Kbps, 30Kbps, 40Kbps, 50Kbps, 64Kbps, 128Kbps, 256Kbps, 512Kbps, 768Kbps, 1Mbps, 2Mbps, 3Mbps, 4Mbps, 6Mbps, 8Mbps, 10Mbps, 12Mbps, 14Mbps, and 16Mbps. You can also select **Customize** and manually enter a value.
- **Fixed quality:** On the other hand, if **Fixed quality** is selected, all frames are transmitted with the same quality; bandwidth utilization is therefore unpredictable. The video quality can be adjusted to the following settings: Medium, Standard, Good, Detailed, and Excellent. You can also select **Customize** and manually enter a value.

If **JPEG** mode is selected, the Network Camera sends consecutive JPEG images to the client, producing a moving effect similar to a filmstrip. Every single JPEG image transmitted guarantees the same image quality, which in turn comes at the expense of variable bandwidth usage. Because the media contents are a combination of JPEG images, no audio data is transmitted to the client. There are three parameters provided in MJPEG mode to control the video performance:

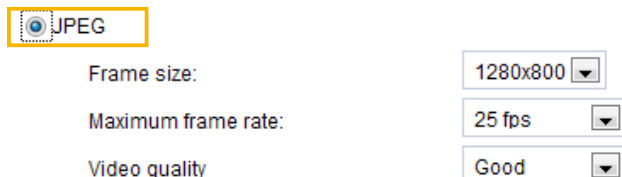

JPEG  
 Frame size: 1280x800  
 Maximum frame rate: 25 fps  
 Video quality: Good

#### ■ Frame size

You can set up different video resolution for different viewing devices. For example, set a smaller frame size and lower bit rate for remote viewing on mobile phones and a larger video size and a higher bit rate for live viewing on web browsers. Note that a larger frame size takes up more bandwidth.

#### ■ Maximum frame rate

This limits the maximum refresh frame rate per second. Set the frame rate higher for smoother video quality.

If the power line frequency is set to 50Hz, the frame rates are selectable at 1fps, 2fps, 3fps, 5fps, 8fps, 10fps, 15fps, 20fps, and 25fps. If the power line frequency is set to 60Hz, the frame rates are selectable at 1fps, 2fps, 3fps, 5fps, 8fps, 10fps, 15fps, 20fps, 25fps, and 30fps. You can also select **Customize** and manually enter a value. The frame rate will decrease if you select a higher resolution.

#### ■ Video quality

The video quality can be adjusted to the following settings: Medium, Standard, Good, Detailed, and Excellent. You can also select **Customize** and manually enter a value.



#### NOTE:

- ▶ *Video quality and fixed quality refers to the **compression rate**, so a lower value will produce higher quality.*
- ▶ *Converting high-quality video may significantly increase the CPU loading, and you may encounter streaming disconnection or video loss while capturing a complicated scene. In the event of occurrence, we suggest you customize a lower video resolution or reduce the frame rate to obtain smooth video.*

## Media > Audio **Advanced Mode**

### Audio Settings

**Audio settings**

Mute

External microphone input gain:

Audio type

AAC bit rate:

GSM-AMR bit rate:

G.711:

**Mute:** Select this option to disable audio transmission from the Network Camera to all clients. Note that if muted, no audio data will be transmitted even if audio transmission is enabled on the Client Settings page. In that case, the following message is displayed:

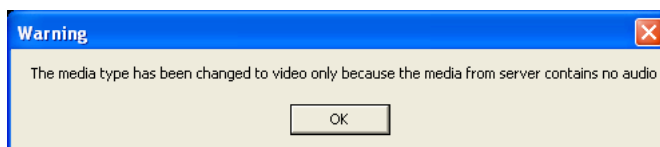

**External microphone input gain:** Select the gain of the external audio input according to ambient conditions. Adjust the gain from +24 db (most sensitive) or -21 db (least sensitive).

**Audio type:** Select audio codec AAC or GSM-AMR and the bit rate **Advanced Mode**.

- AAC provides good sound quality at the cost of higher bandwidth consumption. The bit rates are selectable from: 16Kbps, 32Kbps, 48Kbps, 64Kbps, 96Kbps, and 128Kbps.
- GSM-ARM is designed to optimize speech quality and requires less bandwidth. The bit rates are selectable from: 4.75Kbps, 5.15Kbps, 5.90Kbps, 6.7Kbps, 7.4Kbps, 7.95Kbps, 10.2Kbps, and 12.2Kbps.
- G.711 also provides good sound quality and requires about 64Kbps. Select pcmu ( $\mu$ -Law) or pcma (A-Law) mode.

When completed with the settings on this page, click **Save** to enable the settings.

## PTZ > PTZ settings Advanced Mode

This section explains how to control the Network Camera's Pan/Tilt/Zoom operation. There are two ways to enable the function:

1. Digital: Control the e-PTZ operation. It allows users to quickly move the focus to a target area for close-up viewing without moving the camera physically. Please refer to below for detailed instruction.

### Digital PTZ Operation (E-PTZ Operation)

If you select "Digital", the e-PTZ control settings section will be displayed as shown below:

Activated mode : Digital ▼

Select stream : 1 ▼

(TCP-V) 2011/12/10 17:08:56



▲  
◀ Home ▶  
▼

- Zoom +

Pan speed: 0 ▼

Tilt speed: 0 ▼

Zoom speed: 0 ▼

Auto pan/patrol speed: 1 ▼

Go to: -- Select one -- ▼

**Preset and patrol settings**

Name: Add preset location

<div style="border: 1px solid #ccc; padding: 2px; margin-bottom: 5px;"><input checked="" type="checkbox"/> <b>User preset locations</b></div> <ul style="list-style-type: none"> <li><input checked="" type="checkbox"/> upper right</li> <li><input checked="" type="checkbox"/> lower right</li> <li><input checked="" type="checkbox"/> center</li> <li><input checked="" type="checkbox"/> upper left</li> <li><input checked="" type="checkbox"/> lower left</li> </ul> <div style="border: 1px solid #ccc; padding: 2px; width: fit-content; margin-top: 5px;">Remove</div>	>>	<table border="1" style="width: 100%; border-collapse: collapse;"> <thead> <tr> <th style="text-align: left;">Patrol locations</th> <th style="text-align: right;">Dwell time (sec)</th> </tr> </thead> <tbody> <tr><td><input type="checkbox"/> upper right</td><td style="text-align: right;">5</td></tr> <tr><td><input type="checkbox"/> lower right</td><td style="text-align: right;">5</td></tr> <tr><td><input type="checkbox"/> center</td><td style="text-align: right;">5</td></tr> <tr><td><input type="checkbox"/> upper left</td><td style="text-align: right;">5</td></tr> <tr><td><input type="checkbox"/> lower left</td><td style="text-align: right;">5</td></tr> </tbody> </table> <div style="border: 1px solid #ccc; padding: 2px; display: flex; justify-content: space-between; align-items: center;"> <span>Remove</span> <span>▲ ▼</span> </div>	Patrol locations	Dwell time (sec)	<input type="checkbox"/> upper right	5	<input type="checkbox"/> lower right	5	<input type="checkbox"/> center	5	<input type="checkbox"/> upper left	5	<input type="checkbox"/> lower left	5
Patrol locations	Dwell time (sec)													
<input type="checkbox"/> upper right	5													
<input type="checkbox"/> lower right	5													
<input type="checkbox"/> center	5													
<input type="checkbox"/> upper left	5													
<input type="checkbox"/> lower left	5													

Save

**Select Stream:** Select stream #1 to set up the e-PTZ control. Please note that each stream can possess its own preset and patrol settings. For detailed information about how to set up preset and patrol settings, please refer to page 88.



Auto pan/patrol speed: Select the speed from 1~5 (slow/fast) to set up the Auto pan/patrol speed control.

When completed with the e-PTZ settings, click **Save** to enable the settings on this page.

### Home page in E-PTZ Mode



- The e-Preset Positions will also be displayed on the home page. Select one from the drop-down list, and the Network Camera will move to the selected e-preset position.
- If you have set up different e-preset positions for different streams, you can select one of the video streams to display its separate e-preset positions.

### Global View

In addition to using the e-PTZ control panel, you can also use the mouse to drag or resize the floating frame to pan/tilt/zoom the viewing region. The live view window will also move to the viewing region accordingly.

### Moving Instantly

If you check this item, the live view window will switch to the new viewing region instantly after you move the floating frame.

### Click on Image

The e-PTZ function also supports "Click on Image". When you click on any point of the Global View Window or Live View Window, the viewing region will also move to that point.

Note that the "Click on Image" function only applies when you have configured a smaller "Region of Interest" out of the maximum output frame! e.g., a 800x600 region from the camera's 1280x800 maximum frame size.

Patrol settings

You can select some preset positions for the Network Camera to patrol.  
Please follow the steps below to set up a patrol schedule:

1. Select the preset locations on the list, and click **>>**.
2. The selected preset locations will be displayed on the **Patrol locations** list.
3. Set the **Dwelling time** for the preset location during auto patrol.
4. If you want to delete a preset location from the Patrol locations list, select it and click **Remove**.
5. Select a location and click **▲ ▼** to rearrange the patrol order.
6. Select patrol locations you want to save in the list and click **Save** to enable the patrol settings.
7. To implement the patrol schedule, please go to homepage and click on **Patrol** button. Please refer to the next page.

Activated mode : Digital ▾

Select stream : 1 ▾



Control panel for the camera feed:

- Home button
- Zoom controls: -, Zoom, +
- Pan speed: 0 ▾
- Tilt speed: 0 ▾
- Zoom speed: 0 ▾
- Auto pan/patrol speed: 1 ▾
- Go to: -- Select one -- ▾

**Preset and patrol settings**

Name:

<input checked="" type="checkbox"/> User preset locations	<input type="checkbox"/> Patrol locations	Dwell time (sec)
<input checked="" type="checkbox"/> upper right	<input type="checkbox"/> upper right	5
<input checked="" type="checkbox"/> lower right	<input type="checkbox"/> lower right	5
<input checked="" type="checkbox"/> center	<input type="checkbox"/> center	5
<input checked="" type="checkbox"/> upper left	<input type="checkbox"/> upper left	5
<input checked="" type="checkbox"/> lower left	<input type="checkbox"/> lower left	5

Buttons: Remove, ▲, ▼, Save

## Home page in the e-PTZ Mode

The **Preset positions** will also be displayed on the home page. Select one from the Go to drop-down list, and the Network Camera will move to the selected preset position.

Patrol button: Click this button, then the Network Camera will patrol among the selected preset positions continuously.

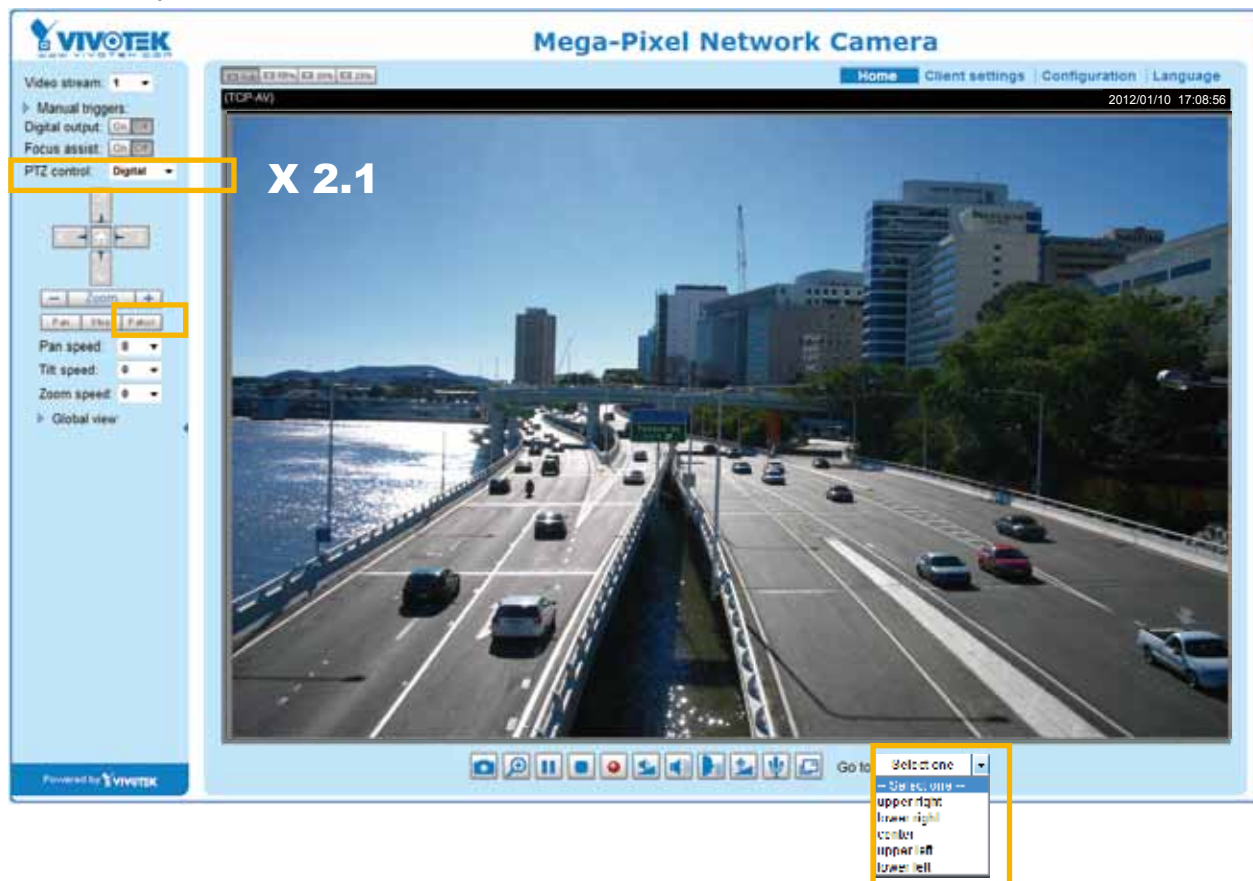

### NOTE:

- ▶ The Preset Positions will also be displayed on the home page. Select one from the Go to drop-down list, and the Network Camera will move to the selected preset position.
- ▶ Click Patrol: The Network Camera will patrol along the selected positions repeatedly. Please refer to page 90 to see more details.

## Event > Event settings Advanced Mode

This section explains how to configure the Network Camera to respond to particular situations (event). A typical application is that when a motion is detected, the Network Camera sends buffered images to an FTP server or e-mail address as notifications. Click on **Help**, there is an illustration shown in the pop-up window explaining that an event can be triggered by many sources, such as motion detection or external digital input devices. When an event is triggered, you can specify what type of action that will be performed. You can configure the Network Camera to send snapshots or videos to your email address or FTP site.

**Event**

Name	Status	Sun	Mon	Tue	Wed	Thu	Fri	Sat	Time	Trigger
<div style="display: flex; align-items: center; gap: 10px;"> <input type="button" value="Add"/> <span style="border: 1px solid blue; padding: 2px;">Help</span> </div>										

```

graph TD
    ET[Event Trigger] --> A[Action (What to do)]
    A --> M[Media (What to send)]
    A --> S[Server (Where to send)]
            
```

**Event Trigger**  
Ex. Motion detection, Periodically, Digital input, System boot

**Media (What to send)**  
Ex. Snapshot, Video Clip, System log, Digital Output

**Server (Where to send)**  
Ex. Email, FTP, HTTP Server, Network storage

### Event

To set an event with recorded video or snapshots, it is necessary to configure the server and media settings so that the Network Camera will know what action to take (such as which server to send the media files to) when a trigger is activated. An event is an action initiated by a user-defined trigger source. In the **Event** column, click **Add** to open the event settings window. Here you can arrange three elements -- Schedule, Trigger, and Action to set an event. A total of 3 event settings can be configured.

**Event**

Name	Status	Sun	Mon	Tue	Wed	Thu	Fri	Sat	Time	Trigger
<div style="display: flex; align-items: center; gap: 10px;"> <div style="border: 2px solid orange; padding: 2px;"><input type="button" value="Add"/></div> <span style="border: 1px solid blue; padding: 2px;">Help</span> </div>										

Event name:

Enable this event

Priority: Normal

Detect next motion detection or digital input after  second(s).

**Event Schedule**

Sun  Mon  Tue  Wed  Thu  Fri  Sat

Time

Always

From  to  [hh:mm]

- **Event name:** Enter a name for the event setting.
- **Enable this event:** Select this option to enable the event setting.
- **Priority:** Select the relative importance of this event (High, Normal, or Low). Events with a higher priority setting will be executed first.
- **Detect next event after  seconds:** Enter the duration in seconds to pause motion detection after a motion is detected. This can prevent event-related actions to be too frequently performed.

### 1. Schedule

Specify the period of them during which the event trigger will take place. Please select the days of the week and the time in a day (in 24-hr time format) for the event triggering schedule.

### 2. Trigger

This is the cause or stimulus which defines when to trigger the Network Camera. The trigger source can be configured to use the Network Camera's built-in motion detection mechanism or external digital input devices.

There are several choices of trigger sources as shown on next page. Select the item to display the detailed configuration options.

- **Video motion detection**

This option makes use of the built-in motion detection mechanism as a trigger source. To enable this function, you need to configure a Motion Detection Window first. For more information, please refer to Motion Detection on page 105 for details.

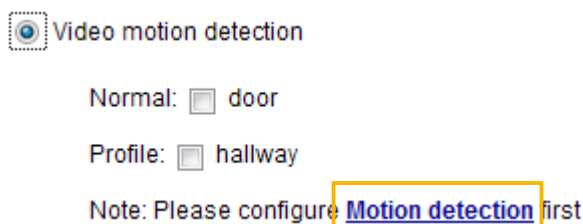

- **Periodically**

This option allows the Network Camera to trigger periodically for every other defined minute. Up to 999 minutes are allowed.

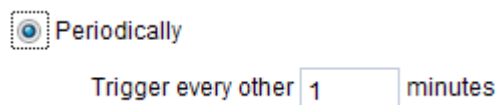

- **Digital input**

This option allows the Network Camera to use an external digital input device or sensor as a trigger source. Depending on your application, there are many choices of digital input devices on the market which helps to detect changes in temperature, vibration, sound, and light, etc.

- **System boot**

This option triggers the Network Camera when the power to the Network Camera is disconnected.

- **Recording notify**

This option allows the Network Camera to trigger when the recording disk is full or when recording starts to rewrite older data.

■ Camera tampering detection

This option allows the Network Camera to trigger when the camera detects that it is being tampered with. To enable this function, you need to configure the Tampering Detection option first. Please refer to page 108 for detailed information.



■ Manual Trigger

This option allows users to enable event triggers manually by clicking the on/off button on the homepage. Please configure 1 to 3 associated events before using this function.

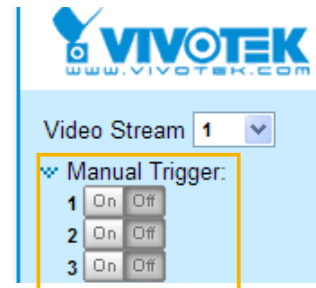
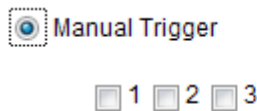

3. Action

Define the actions to be performed by the Network Camera when a trigger is activated.

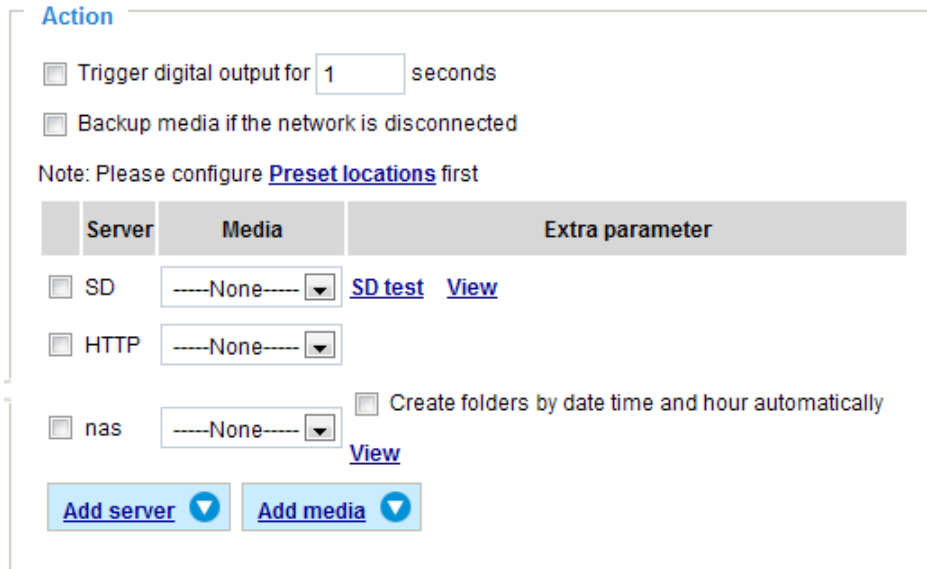

■ Trigger digital output for  seconds

Select this option to turn on the external digital output device when a trigger is activated. Specify the length of the trigger interval in the text box.

■ Backup media if the network is disconnected

Select this option to backup media file on SD card if the network is disconnected. This function will only be displayed after you set up a network storage (NAS).

## Add server

To set an event with recorded video or snapshots, it is necessary to configure the server and media settings so that the Network Camera will know what action to take (such as which server to send the media files to) when a trigger is activated. Click **Add server** to open the server setting window. You can specify where the notification messages are sent when a trigger is activated. A total of 5 server settings can be configured.

There are four choices of server types available: Email, FTP, HTTP, and Network storage. Select the item to display the detailed configuration options. You can configure either one or all of them.

### Server type - Email

Select to send the media files via email when a trigger is activated.

- Server name: Enter a name for the server setting.
- Sender email address: Enter the email address of the sender.
- Recipient email address: Enter the email address of the recipient.
- Server address: Enter the domain name or IP address of the email server.
- User name: Enter the user name of the email account if necessary.
- Password: Enter the password of the email account if necessary.
- Server port: The default mail server port is set to 25. You can also manually set another port.

If your SMTP server requires a secure connection (SSL), check **This server requires a secure connection (SSL)**.

To verify if the email settings are correctly configured, click **Test**. The result will be shown in a pop-up window. If successful, you will also receive an email indicating the result.



Click **Save server** to enable the settings.

Note that after you set up the first event server, the new event server will automatically display on the Server list. If you wish to add other server options, click **Add server**.

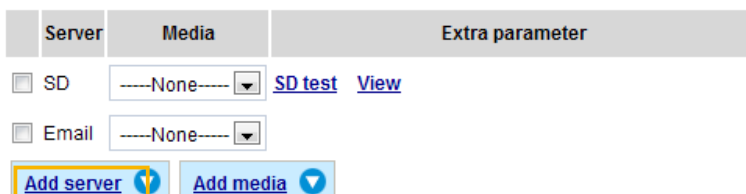

### Server type - FTP

Select to send the media files to an FTP server when a trigger is activated.

Server name:

Server Type

Email

FTP

Server address:

Server port:

User name:

Password:

FTP folder name:

Passive mode

HTTP

Network storage

- Server name: Enter a name for the server setting.
- Server address: Enter the domain name or IP address of the FTP server.
- Server port: By default, the FTP server port is set to 21. It can also be assigned to another port number between 1025 and 65535.
- User name: Enter the login name of the FTP account.
- Password: Enter the password of the FTP account.
- FTP folder name  
Enter the folder where the media file will be placed. If the folder name does not exist, the Network Camera will automatically create one on the FTP server.



#### ■ Passive mode

Most firewalls do not accept new connections initiated from external requests. If the FTP server supports passive mode, select this option to enable passive mode FTP and allow data transmission to pass through the firewall. The firmware default has the Passive mode checkbox selected.

To verify if the FTP settings are correctly configured, click **Test**. The result will be shown in a pop-up window as shown below. If successful, you will also receive a test.txt file on the FTP server.

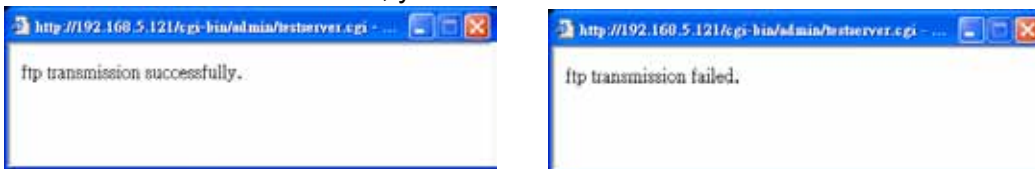

Click **Save server** to enable the settings.

#### Server type - HTTP

Select to send the media files to an HTTP server when a trigger is activated.

■ Server name: Enter a name for the server setting.

■ URL: Enter the URL of the HTTP server.

■ User name: Enter the user name if necessary.

■ Password: Enter the password if necessary.

To verify if the HTTP settings are correctly configured, click **Test**. The result will be shown in a pop-up window as below. If successful, you will receive a test.txt file on the HTTP server.

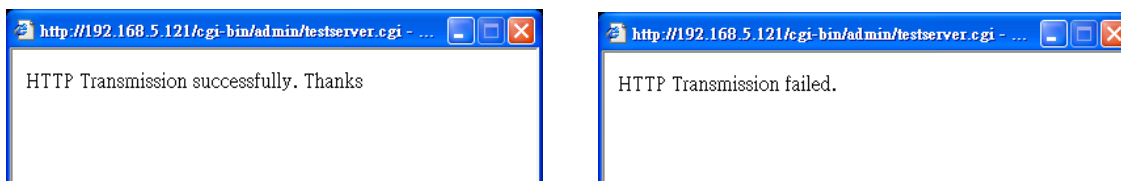

Click **Save server** to enable the settings.

**Network storage:**

Select to send the media files to a network storage location when a trigger is activated. Please refer to **NAS server** on page 112 for details.

Click **Save server** to enable the settings.

**Action**

Trigger digital output for  seconds

Backup media if the network is disconnected

Note: Please configure [Preset locations](#) first

Server	Media	Extra parameter
<input type="checkbox"/> SD	----None----	<a href="#">SD test</a> <a href="#">View</a>
<input type="checkbox"/> Email	----None----	
<input type="checkbox"/> FTP	----None----	
<input type="checkbox"/> HTTP	----None----	
<input type="checkbox"/> NAS	----None----	<input type="checkbox"/> Create folders by date time and hour automatically <a href="#">View</a>

[Add server](#) [Add media](#)

[Close](#) [Save event](#)

- **SD Test:** Click to test your SD card. The system will display a message indicating success or failure. If you want to use your SD card for local storage, please format it before use. Please refer to page 100 for detailed information.
- **View:** Click this button to open a file list window. This function is only for SD card and Network Storage. If you click the View button of SD card, a Local storage page will pop up for you to manage recorded files on SD card. For more information about Local storage, please refer to page 114. If you click the View button of Network storage, a file directory window will pop up for you to view recorded data on Network storage. For detailed illustration, please refer to the next page.
- **Create folders by date, time, and hour automatically:** If you check this item, the system will generate folders automatically by the date when video footages are stored onto the networked storage.

The following is an example of a file destination with video clips:

The format is: YYYYMMDD  
Click to open the directory

Click to delete selected items

Click to delete all recorded data

Click [20110220](#) to open the directory:

**The format is: HH (24r)**

Click to open the file list for that hour

< 07 08 09 10 11 12 13 14 15 16 17 >

	file name	size	date	time
<input type="checkbox"/>	<a href="#">Recording1 58.mp4</a>	2526004	2011/02/20	07:58:28
<input type="checkbox"/>	<a href="#">Recording1 59.mp4</a>	2563536	2011/02/20	07:59:28

Click to delete selected items

Click to go back to the previous level of the directory

Click to delete all recorded data

< 07 08 09 10 11 12 13 14 15 16 17 >

	file name	size	date	time
<input type="checkbox"/>	<a href="#">Recording1 58.mp4</a>	2526004	2011/02/20	07:58:28
<input type="checkbox"/>	<a href="#">Recording1 59.mp4</a>	2563536	2011/02/20	07:59:28

**The format is: File name prefix + Minute (mm)**

You can set up the file name prefix on Add media page. Please refer to next page for detailed information.

## Add media

Click **Add media** to open the media setting window. You can specify the type of media that will be sent when a trigger is activated. A total of 5 media settings can be configured. There are three choices of media types available: Snapshot, Video Clip, and System log. Select the item to display the detailed configuration options. You can configure either one or all of them.

### Media type - Snapshot

Select to send snapshots when a trigger is activated.

- Media name: Enter a name for the media setting.
- Source: Select to take snapshots from stream 1 ~ 2.
- Send  pre-event images  
The Network Camera has a buffer area; it temporarily holds data up to a certain limit. Enter a number to decide how many images to capture before a trigger is activated. Up to 7 images can be generated.
- Send  post-event images  
Enter a number to decide how many images to capture after a trigger is activated. Up to 7 images can be generated.

For example, if both the Send pre-event images and Send post-event images are set to 7, a total of 15 images are generated after a trigger is activated.

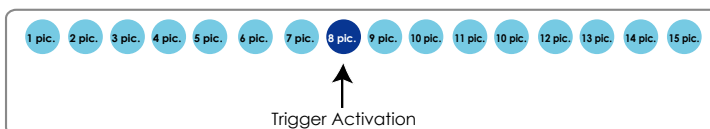

- File name prefix  
Enter the text that will be appended to the front of the file name.

- Add date and time suffix to the file name  
Select this option to add a date/time suffix to the file name.  
For example:

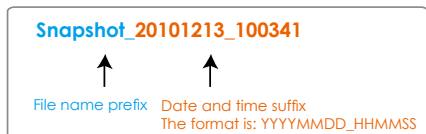

Click **Save media** to enable the settings.

To note that after you set up the first media server, a new column for media server will automatically show up on the Media list. If you wish to add more other media options, click **Add media**.

Media type - Video clip

Select to send video clips when a trigger is activated.

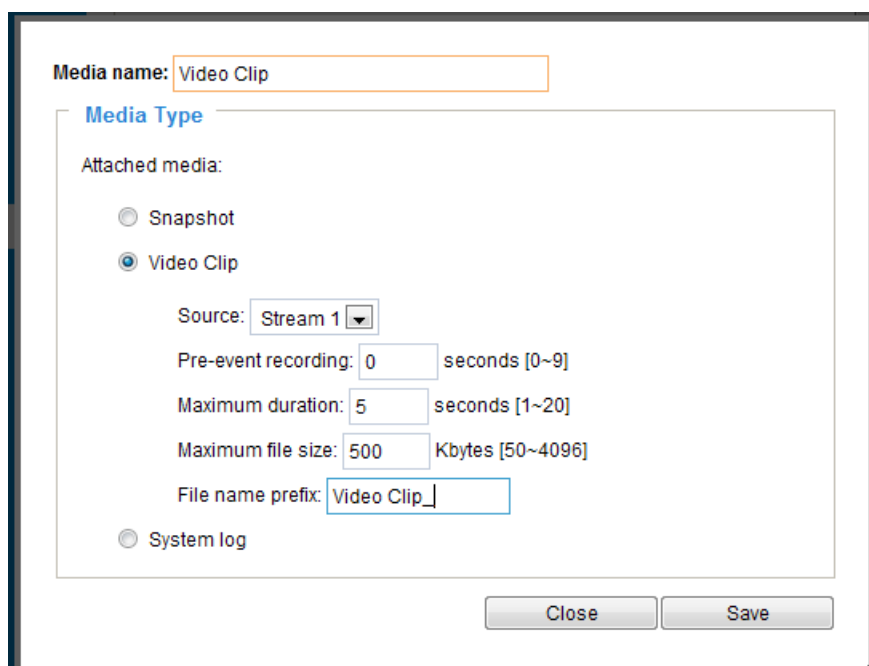

- Media name: Enter a name for the media setting.
- Source: Select the source of video clip.
- Pre-event recording  
The Network Camera has a buffer area; it temporarily holds data up to a certain limit. Enter a number to decide the duration of recording before a trigger is activated. Up to 9 seconds can be set.
- Maximum duration  
Specify the maximum recording duration in seconds. Up to 10 seconds can be set.  
For example, if pre-event recording is set to five seconds and the maximum duration is set to ten seconds, the Network Camera continues to record for another 4 seconds after a trigger is activated.

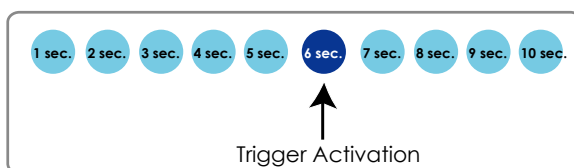

- **Maximum file size**  
Specify the maximum file size allowed.
- **File name prefix**  
Enter the text that will be appended to the front of the file name.  
For example:



Click **Save media** to enable the settings.

Media type - System log

Select to send a system log when a trigger is activated.

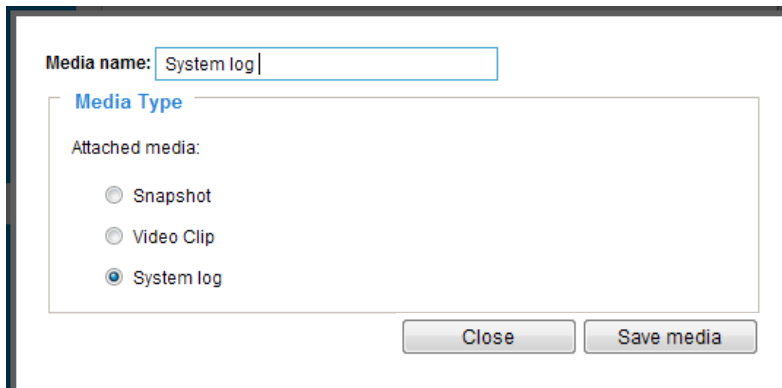

Click **Save media** to enable the settings, then click **Close** to exit the page.

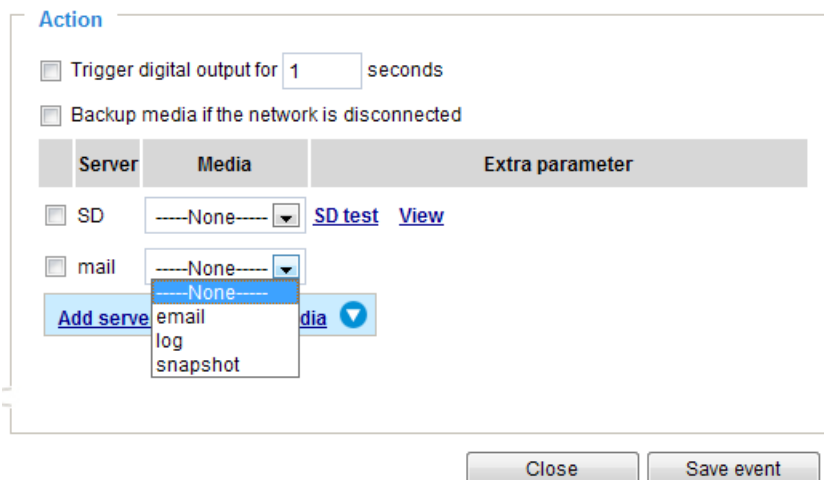

In the Event settings column, the Servers and Medias you configured will be listed; please make sure the Event -> Status is indicated as **ON**, in order to enable the event triggering action.

When completed, click **Save event** to enable the settings and click **Close** to exit Event Settings page. The new Event / Server settings / Media will appear in the event drop-down list on the Event setting page.

Please see the example of the Event setting page below:

**Event**

Name	Status	Sun	Mon	Tue	Wed	Thu	Fri	Sat	Time	Trigger	
<a href="#">event1</a>	<b>ON</b>	V	V	V	V	V	V	V	00:00~24:00	seq	<input type="button" value="Delete"/>

[Help](#)

**Server settings**

Name	Type	Address/Location	
<a href="#">HTTP</a>	http	http://192.168.5.10	<input type="button" value="Delete"/>

**Media**

Available memory space: 13000KB

Name	Type	
<a href="#">Snapshot</a>	snapshot	<input type="button" value="Delete"/>
<a href="#">Video clip</a>	videoclip	<input type="button" value="Delete"/>
<a href="#">System log</a>	systemlog	<input type="button" value="Delete"/>

**Customized script**

Name	Date	Time
------	------	------

When the Event Status is **ON**, once an event is triggered by motion detection, the Network Camera will automatically send snapshots via e-mail.

If you want to stop the event trigger, you can click **ON** to turn it to **OFF** status or click **Delete** to remove the event setting.

To remove a server setting from the list, select a server name from the drop-down list and click **Delete**. Note that you can only delete a server setting when it is not applied to an event setting.

To remove a media setting from the list, select a media name from the drop-down list and click **Delete**. Note that you can only delete a media setting when it is not applied to an event setting.

## Customized Script

This function allows you to upload a sample script (.xml file) to the webpage, which will save your time on configuring the settings. Please note that there is a limited number of customized scripts you can upload; if the current amount of customized scripts has reached the limit, an alert message will prompt. If you need more information, please contact VIVOTEK technical support.

### Customized Script

Name	Date	Time
<a href="#">User1</a>	20081113	18:13:46
<a href="#">User2</a>	20081113	18:11:32

Click to upload a file

```

<?xml version="1.0" encoding="UTF-8"?>
<eventmgr version="0102">
  <mgprocess></mgprocess>
  <!-- from 08:30:00-20:30:00 on Monday to Friday every week -->
  <schedule id="0">
    <duration>
      <weekdays>1-5</weekdays>
      <time>08:30:00-20:30:00</time>
    </duration>
  </schedule>
  <!-- Motion -->
  <action condition="0">
    <status id="0"><trigger/></status>
    <status id="1"><trigger/></status>
  </action>
  <event id="0">
    <description>Mail system log to email address</description>
    <condition></condition>
    <scheduleid></scheduleid>
    <delay>0</delay>
    <!-- users can send email with title "Notice" to recipient pudding.yang@vivotek.com. The body of mail is the log messages -->
    <process>
      /usr/bin/empollent -s "Notice" -f IP"193@vivotek.com -b /var/log/messages -S ma.vivotek.tw -
      M S pudding.yang@vivotek.com
    </process>
    <priority>0</priority>
  </event>
</eventmgr>
                
```

Click to modify the script online



## Applications > Motion detection

This section explains how to configure the Network Camera to enable motion detection. A total of three motion detection windows can be configured.

Enable motion detection

(TCP-V) 2011/11/3 14:39:12

Window name:  
hallway

Sensitivity: 67%

Percentage: 18%

New Save

Profile

Motion Detection Setting 1:  
For normal situations

Motion Detection Setting 2:  
For special situations

Follow the steps below to enable motion detection:

1. Click **New** to add a new motion detection window.
2. In the Window Name text box, enter a name for the motion detection window.
  - To move and resize the window, drag and drop your mouse on the window.
  - To delete a window, click X on the upper right corner of the window.
3. Define the sensitivity to moving objects and the space ratio of all alerted pixels by moving the Sensitivity and Percentage slider bar.
4. Click **Save** to enable the settings.
5. Select **Enable motion detection** to enable this function.

For example:

Enable motion detection

(TCP-V) 2011/11/3 14:39:12

Window name:  
hallway

Sensitivity: 67%

Percentage: 18%

New Save

Profile

The Percentage Indicator will rise or fall depending on the variation between sequential images. When motions are detected by the Network Camera and are judged to exceed the defined threshold, the red bar rises. Meanwhile, the motion detection window will be outlined in red. Photos or videos can be captured instantly and configured to be sent to a remote server (Email, FTP) by utilizing this feature as a trigger source. For more information on how to set an event, please refer to Event settings on page 92.

A green bar indicates that even though motions have been detected, the event has not been triggered because the image variations still fall under the defined threshold.

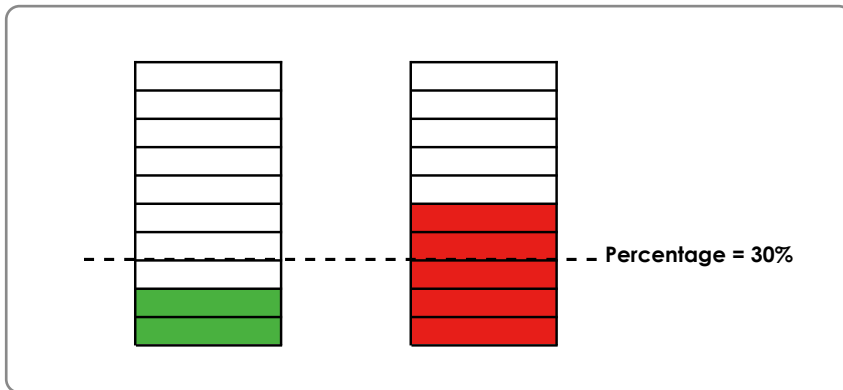

If you want to configure other motion detection settings for day/night/schedule mode, please click **Profile** to open the Motion Detection Profile Settings page as shown below. A total of three motion detection windows can be configured on this page as well.

**>Motion detection profile settings**

(TCP-V) 2011/11/3 14:48:39



Window name:

Sensitivity: 63%

Percentage: 17%

**General settings**

Enable this profile

This profile is applied to:

Day mode

Night mode

Schedule mode

Please follow the steps below to set up a profile:

1. Create a new motion detection window.
2. Check **Enable this profile**.
3. Select the applicable mode: Day mode, Night mode, or Schedule mode. Please manually enter a time range if you choose Schedule mode.
4. Click **Save** to enable the settings and click **Close** to exit the page.

This motion detection window will also be displayed on the Event Settings page. You can go to Event > Event settings > Trigger to choose it as a trigger source. Please refer to page 110 for detailed information.

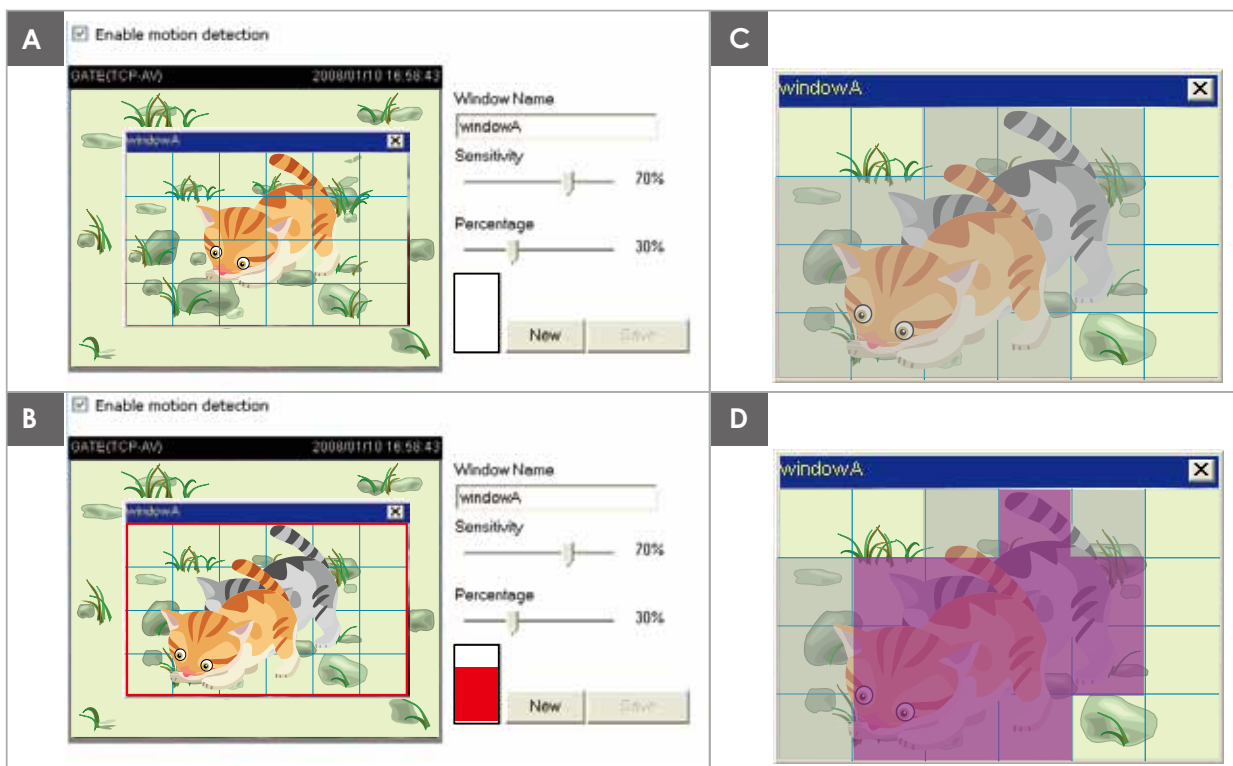
**NOTE:**► *How does motion detection work?*

There are two motion detection parameters: *Sensitivity* and *Percentage*. In the illustration above, frame A and frame B are two sequential images. Pixel differences between the two frames are detected and highlighted in gray (frame C) and will be compared with the sensitivity setting. *Sensitivity* is a value that expresses the sensitivity to moving objects. Higher sensitivity settings are expected to detect slight movements while smaller sensitivity settings will neglect them. When the sensitivity is set to 70%, the Network Camera defines the pixels in the purple areas as “alerted pixels” (frame D).

*Percentage* is a value that expresses the proportion of “alerted pixels” to all pixels in the motion detection window. In this case, 50% of pixels are identified as “alerted pixels”. When the percentage is set to 30%, the motions are judged to exceed the defined threshold; therefore, the motion window will be outlined in red.

For applications that require a high level of security management, it is suggested to use higher sensitivity settings and smaller percentage values.

## Applications > DI and DO Advanced Mode

**DI and DO**

Digital input 1: The active state is Low ; the current state detected is **High**

Digital input 2: The active state is Low ; the current state detected is **High**

Digital input 3: The active state is Low ; the current state detected is **High**

Digital output: The active state is Grounded ; the current state detected is **Open**

Save

Connect DI or DO devices to the camera's terminal block, the camera will automatically detect the current connection state as pulled-high or pulled-low. You may then define the triggering condition.

Digital input: Select High or Low to define the "active state" for the digital input. The Network Camera will report the current status.

Digital output: Select Grounded or Open to define the "active state" for the digital output. The Network Camera will show whether the trigger is activated or not.

## Applications > Tampering detection

This section explains how to set up camera tamper detection. With tamper detection, the camera is capable of detecting incidents such as **redirection, blocking or defocusing**, or even **spray paint**.

**Camera tampering detection**

Enable camera tampering detection

Trigger duration 10 seconds [10~600]

Save

Please follow the steps below to set up the camera tamper detection function:

1. Check **Enable camera tampering detection**.
2. Enter the tamper trigger duration. (10 sec. ~ 10 min.) The tamper alarm will be triggered only when the tampering factor (the difference between current frame and pre-saved background) exceeds the trigger threshold.
3. Set up the event source as Camera Tampering Detection on **Event > Event settings > Trigger**. Please refer to page 110 for detailed information.

## Recording > Recording settings Advanced Mode

This section explains how to configure the recording settings for the Network Camera.

### Recording Settings

Insert your SD card and click here to test

**Recording settings**

Name	Status	Sun	Mon	Tue	Wed	Thu	Fri	Sat	Time	Source	Destination	Delete
<div style="display: flex; justify-content: space-between; align-items: center;"> <span>Add</span> <span><a href="#">SD test</a></span> </div>												

Note: Before setup recording, you may setup network storage via [NAS server](#) page



#### **NOTE:**

- ▶ Please remember to format your SD card when using it for the first time. Please refer to page 114 for detailed information.

### Recording Settings

Click **Add** to open the recording setting window. On this page, you can define the adaptive recording, recording source, recording schedule, and recording capacity. A total of 2 recording settings can be configured.

Recording name:

Enable this recording

With adaptive recording

Pre-event recording:  seconds [0~9]

Post-event recording:  seconds [0~10]

Priority:

Source:

1. Trigger

**Trigger**

Schedule

Sun  Mon  Tue  Wed  Thu  Fri  Sat

**Time**

Always

From  to  [hh:mm]

Network fail

2. Destination

Note: To enable recording notification please configure [Event](#) first

- Recording name: Enter a name for the recording setting.
- Enable this recording: Select this option to enable video recording.
- With adaptive recording: Select this option will activate the frame rate control according to alarm trigger. The frame control means that when there is a triggered alarm, the frame rate will raise up to the value you've set on Video quality page. Please refer to page 87 for more information.

If you enable adaptive recording and enable time-shift cache stream on Camera A, only when an event is triggered on Camera A will the server record the full frame rate streaming data; otherwise, it will only request the I frame data during normal monitoring, thus effectively save lots of bandwidths and storage space.

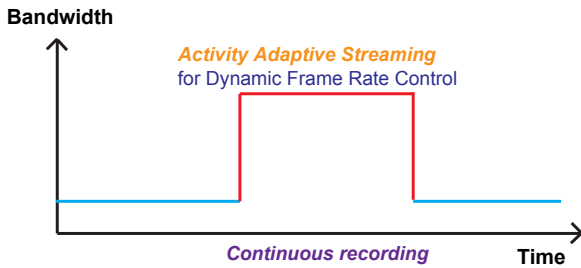
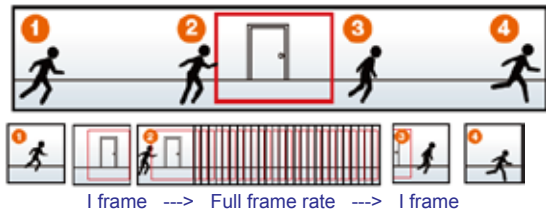

**NOTE:**

- ▶ To enable adaptive recording, please make sure you've set up the trigger source such as Motion Detection, DI Device, or Manual Trigger.
- ▶ When there is no alarm trigger:
  - JPEG mode: record 1 frame per second.
  - H.264 mode: record 1 frame only.
  - MPEG-4 mode: record the I frame only.
- ▶ When the I frame period is >1s on Video settings page, firmware will force decrease the I frame period to 1s when adaptive recording is enabled.

The alarm trigger includes: motion detection and DI detection. Please refer to Event Settings on page 92.

- Pre-event recording and post-event recording  
The Network Camera has a buffer area; it temporarily holds data up to a certain limit. Enter a number to decide the duration of recording before and after a trigger is activated.
- Priority: Select the relative importance of this recording (High, Normal, or Low). Recording with a higher priority setting will be executed first.
- Source: Select a stream for the recording source.

**NOTE:**

- ▶ To enable recording notification please configure **Event settings** first . Please refer to page 92.

Please follow the steps below to set up the recording.

1. Trigger

Select a trigger source.

**Trigger**

Schedule

Sun  Mon  Tue  Wed  Thu  Fri  Sat

**Time**

Always

From  to  [hh:mm]

Network fail

- Schedule: The server will start to record files on the local storage or network storage (NAS).
- Network fail: Since network fail, the server will start to record files on the local storage (SD card).

## 2. Destination

You can select the SD card or network storage (NAS) for the recorded video files.



## NAS server

Click **Add NAS server** to open the server setting window and follow the steps below to set up:

1. Fill in the information for your server.

For example:

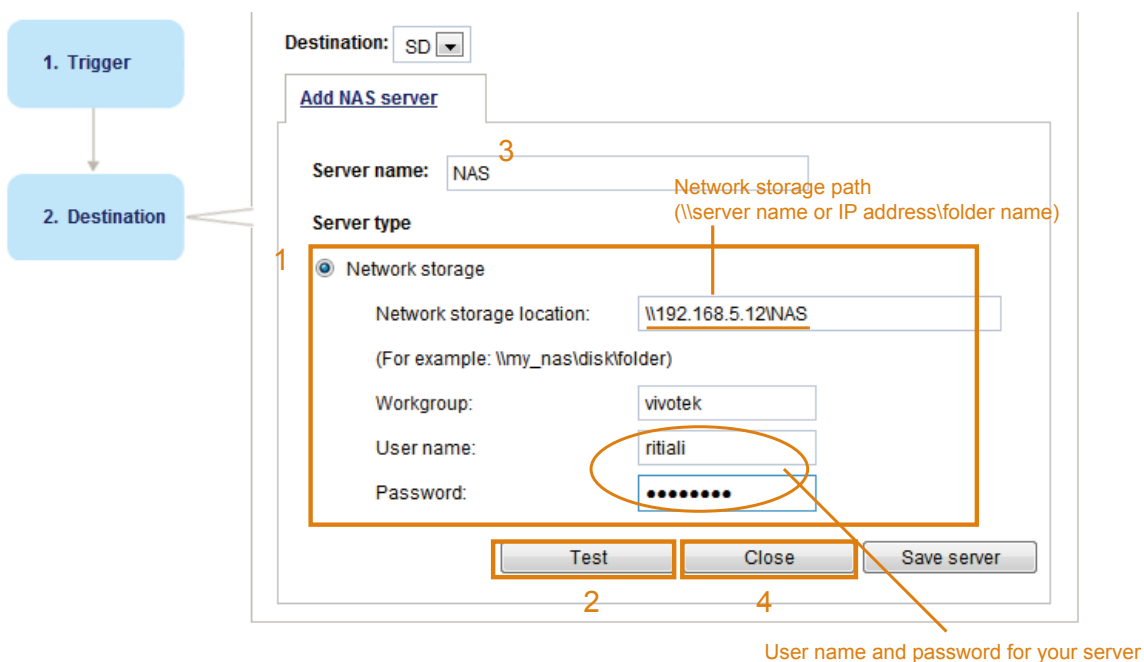

2. Click **Test** to check the setting. The result will be shown in the pop-up window.

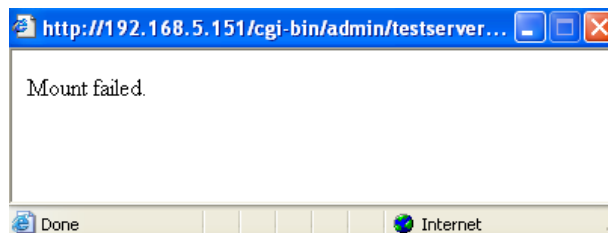
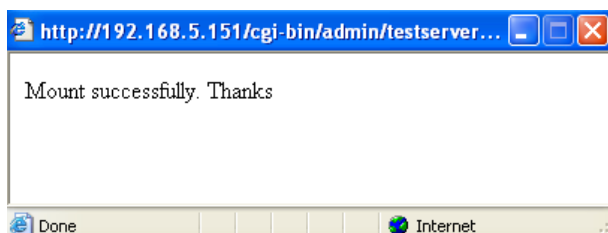

If successful, you will receive a test.txt file on the network storage server.

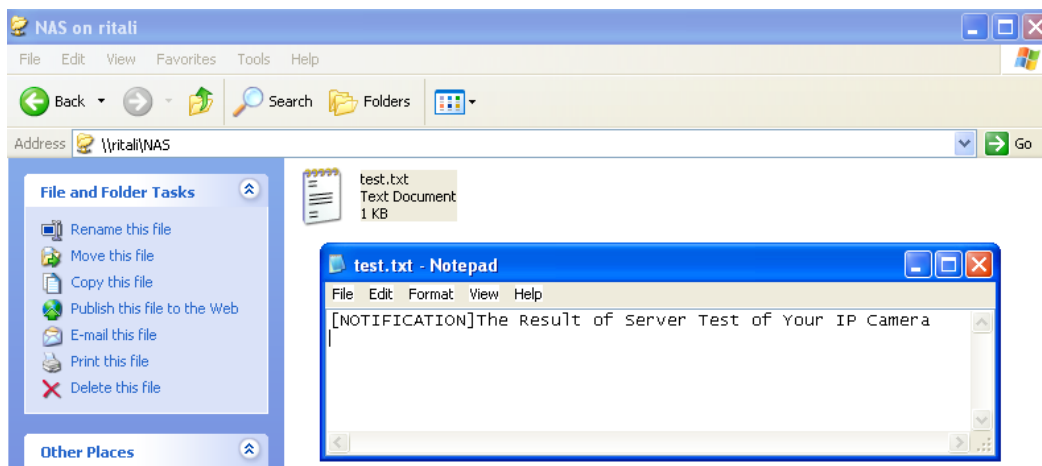

3. Enter a server name.

4. Click **Save** to complete the settings and click **Close** to exit the page.

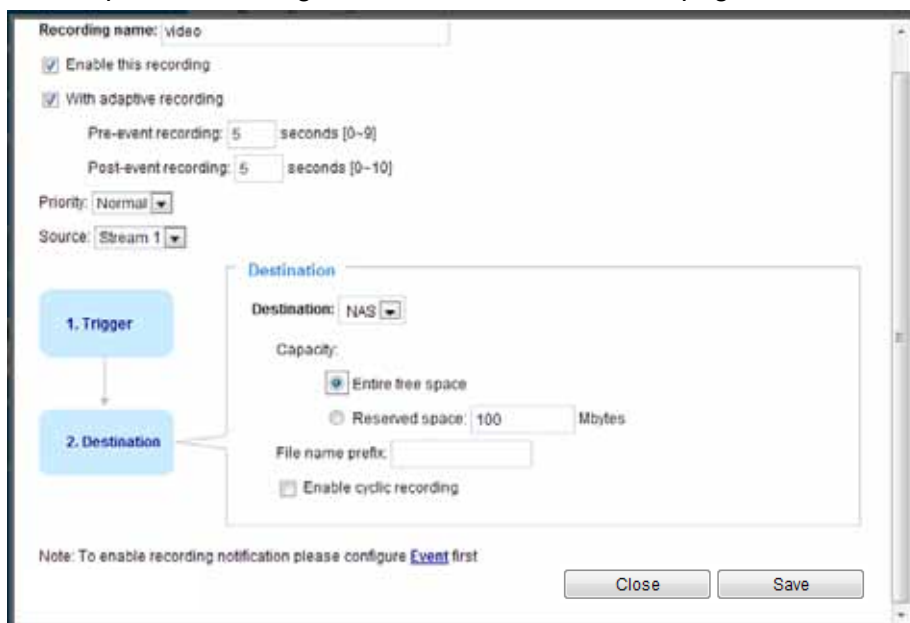

- **Capacity:** You can choose either the entire free space available or limit the reserved space. The recording size limit must be larger than the reserved amount for cyclic recording.
- **File name prefix:** Enter the text that will be appended to the front of the file name.
- **Enable cyclic recording:** If you check this item, when the maximum capacity is reached, the oldest file will be overwritten by the latest one. The reserved amount is reserved for the transaction stage when the storage space is about to be full and new data arrives. The minimum for the Reserved space must be larger than 15 MBytes.

If you want to enable recording notification, please click **Event** to configure event triggering settings. Please refer to **Event > Event settings** on page 92 for more details.

When completed, select **Enable this recording**. Click **Save** to enable the setting and click **Close** to exit this page. When the system begins recording, it will send the recorded files to the network storage. The new recording name will appear in the drop-down list on the recording page as shown below.



To remove a recording setting from the list, select a recording name from the drop-down list and click **Delete**.

**Recording Settings**

Note: Before setup recording, you have to setup network storage first via [Server](#) page

Name	Status	Sun	Mon	Tue	Wed	Thu	Fri	Sat	Time	Source	Destination
<a href="#">Video</a>	<a href="#">ON</a>	V	V	V	V	V	V	V	00:00~24:00	stream1	<a href="#">NAS</a>

- Click [Video \(Name\)](#): Opens the Recording Settings page to modify.
- Click [ON \(Status\)](#): The Status will become [OFF](#) and stop recording.
- Click [NAS \(Destination\)](#): Opens the file list of recordings as shown below. For more information about folder naming rules, please refer to page 98 for details.

<input type="checkbox"/>	<a href="#">20101210</a>
<input type="checkbox"/>	<a href="#">20101211</a>
<input type="checkbox"/>	<a href="#">20101212</a>

## Local storage > SD card management Advanced Mode

This section explains how to manage the local storage on the Network Camera. Here you can view SD card status, and implement SD card control.

### SD card status

This column shows the status and reserved space of your SD card. Please remember to format the SD card when using for the first time.

**SD card status**

SD card status: Detached — no SD card

Total size: 0 KBytes Free size: 0 KBytes

Used size: 0 KBytes Use (%): 0 %

**SD card status**

SD card status: Ready

Total size:	7810152 KBytes	Free size:	7602048 KBytes
Used size:	208104 KBytes	Use (%):	2.665 %

### SD card control

**SD card control**

Enable cyclic storage

Enable automatic disk cleanup

Maximum duration for keeping files:  days

- **Enable cyclic storage:** Check this item if you want to enable cyclic recording. When the maximum capacity is reached, the oldest file will be overwritten by the latest one.
- **Enable automatic disk cleanup:** Check this item and enter the number of days you wish to retain a file. For example, if you enter “7 days”, the recorded files will be stored on the SD card for 7 days.

Click **Save** to enable your settings.

## Local storage > Content management Advanced Mode

This section explains how to manage the content of recorded videos on the Network Camera. Here you can search and view the records and view the searched results.

### Searching and Viewing the Records

This column allows the user to set up search criteria for recorded data. If you do not select any criteria and click **Search** button, all recorded data will be listed in the **Search Results** column.

**Searching and viewing the records**

✦ File attributes

Trigger type:  System boot     Recording notify     Motion  
 Digital input     Network fail     Periodically  
 Manual triggers     Tampering detection

Media type:  Video clip     Snapshot     Text

Locked:  Locked     Unlocked

Backup:  Backup

✦ Trigger time

From:    Date     Time   
to:    Date     Time   
          (yyyy-mm-dd)                    (hh:mm:ss)

- File attributes: Select one or more items as your search criteria.
- Trigger time: Manually enter the time range you want to search.

Click **Search** and the recorded data corresponding to the search criteria will be listed in **Search Results** window.

## Search Results

The following is an example of search results. There are four columns: Trigger time, Media type, Trigger type, and Locked. Click  to sort the search results in either direction.





Numbers of entries displayed on one page

Enter a key word to filter the search results

Search results

Show 10 entries

Search:

	Trigger time 	Media Type 	Trigger type 	Locked 	Backup 
<input checked="" type="checkbox"/>	2010-08-26 10:42:55	Video Clip	Periodically	No	No
<input type="checkbox"/>	2010-08-26 10:43:56	Video Clip	Periodically	No	No
<input type="checkbox"/>	2010-08-26 10:44:56	Video Clip	Periodically	No	No
<input type="checkbox"/>	2010-08-26 10:45:57	Video Clip	Periodically	No	No
<input type="checkbox"/>	2010-08-26 10:46:58	Video Clip	Periodically	No	No
<input type="checkbox"/>	2010-08-26 10:47:59	Video Clip	Periodically	No	No

Highlight an item

- View: Click on a search result which will highlight the selected item in purple as shown above. Click the **View** button and a media window will pop up to play back the selected file. For example:



Click to adjust the image size

- Download: Click on a search result to highlight the selected item in purple as shown above. Then click the **Download** button and a file download window will pop up for you to save the file.
- JPEGs to AVI: This functions only applies to “JPEG“ format files such as snapshots. You can select several snapshots from the list, then click this button. Those snapshots will be converted into an AVI file.

- Lock/Unlock:** Select the desired search results, then click this button. The selected items will become Locked, which will not be deleted during cyclic recording. You can click again to unlock the selections. For example:

Search results

Show  entries Search:

	Trigger time	Media Type	Trigger type	Locked	Backup
<input checked="" type="checkbox"/>	2010-08-26 10:42:55	Video Clip	Periodically	Yes	No
<input checked="" type="checkbox"/>	2010-08-26 10:43:56	Video Clip	Periodically	Yes	No
<input checked="" type="checkbox"/>	2010-08-26 10:44:56	Video Clip	Periodically	Yes	No
<input type="checkbox"/>	2010-08-26 10:45:57	Video Clip	Periodically	No	No
<input type="checkbox"/>	2010-08-26 10:46:58	Video Clip	Periodically	No	No
<input type="checkbox"/>	2010-08-26 10:47:59	Video Clip	Periodically	No	No
<input type="checkbox"/>	2010-08-26 10:49:00	Video Clip	Periodically	No	No
<input type="checkbox"/>	2010-08-26 10:50:00	Video Clip	Periodically	No	No
<input type="checkbox"/>	2010-08-26 10:51:01	Video Clip	Periodically	No	No
<input type="checkbox"/>	2010-08-26 10:52:00	Video Clip	Periodically	No	No

Showing 1 to 10 of 12 entries

Note: "View" and "Download" only apply to the highlight item

Click to switch pages

- Remove:** Select the desired search results, then click this button to delete the files.

# Appendix

## URL Commands for the Network Camera

### 1. Overview

For some customers who already have their own web site or web control application, the Network Camera/Video Server can be easily integrated through URL syntax. This section specifies the external HTTP-based application programming interface. The HTTP-based camera interface provides the functionality to request a single image, control camera functions (PTZ, output relay etc.), and get and set internal parameter values. The image and CGI-requests are handled by the built-in Web server.

### 2. Style Convention

In URL syntax and in descriptions of CGI parameters, text within angle brackets denotes content that is to be replaced with either a value or a string. When replacing the text string, the angle brackets should also be replaced. An example of this is the description of the name for the server, denoted with `<servername>` in the URL syntax description below, that is replaced with the string `myserver` in the URL syntax example further down in the page.

URL syntax is denoted with the word "Syntax:" written in bold face followed by a box with the referenced syntax as shown below. For example, name of the server is written as `<servername>` and is intended to be replaced with the name of the actual server. This can either be a name, e.g., "mywebcam" or "thecam.adomain.net" or the associated IP number for the server, e.g., 192.168.0.220.

Syntax:

```
http://<servername>/cgi-bin/viewer/video.jpg
```

Description of returned data is written with "Return:" in bold face followed by the returned data in a box. All data is returned in HTTP format, i.e., each line is separated with a Carriage Return and Line Feed (CRLF) printed as `\r\n`.

Return:

```
HTTP/1.0 <HTTP code> <HTTP text>\r\n
```

URL syntax examples are written with "Example:" in bold face followed by a short description and a light grey box with the example.

**Example:** request a single snapshot image

```
http://mywebserver/cgi-bin/viewer/video.jpg
```

### 3. General CGI URL Syntax and Parameters

CGI parameters are written in lower-case and as one word without any underscores or other separators. When the CGI request includes internal camera parameters, these parameters must be written exactly as they are named in the camera or video server. The CGIs are organized in functionally-related directories under the cgi-bin directory. The file extension .cgi is required.

Syntax:

```
http://<servername>/cgi-bin/<subdir>[/<subdir>...]/<cgi>.<ext>
[?<parameter>=<value>[&<parameter>=<value>...]]
```

**Example:** Set digital output #1 to active

<http://mywebserver/cgi-bin/dido/setdo.cgi?dol=1>

### 4. Security Level

SECURITY LEVEL	SUB-DIRECTORY	DESCRIPTION
0	anonymous	Unprotected.
1 [view]	anonymous, viewer, dido, camctrl	1. Can view, listen, talk to camera. 2. Can control DI/DO, PTZ of the camera.
4 [operator]	anonymous, viewer, dido, camctrl, operator	Operator access rights can modify most of the camera's parameters except some privileges and network options.
6 [admin]	anonymous, viewer, dido, camctrl, operator, admin	Administrator access rights can fully control the camera's operations.
7	N/A	Internal parameters. Unable to be changed by any external interfaces.

### 5. Get Server Parameter Values

**Note:** The access right depends on the URL directory.

**Method:** GET/POST

Syntax:

```
http://<servername>/cgi-bin/<anonymous>/getparam.cgi?[<parameter>]
[&<parameter>...]

http://<servername>/cgi-bin/<viewer>/getparam.cgi?[<parameter>]
```

```
[&<parameter>...]

http://<servername>/cgi-bin/operator/getparam.cgi?[<parameter>]

[&<parameter>...]

http://<servername>/cgi-bin/admin/getparam.cgi?[<parameter>]

[&<parameter>...]
```

Where the *<parameter>* should be *<group>[\_<name>]* or *<group>[.<name>]*. If you do not specify any parameters, all the parameters on the server will be returned. If you specify only *<group>*, the parameters of the related group will be returned.

When querying parameter values, the current parameter values are returned.

A successful control request returns parameter pairs as follows:

Return:

```
HTTP/1.0 200 OK\r\n
Content-Type: text/html\r\n
Context-Length: <length>\r\n
\r\n
<parameter pair>
```

where *<parameter pair>* is

```
<parameter>=<value>\r\n
```

```
[<parameter pair>]
```

*<length>* is the actual length of content.

### **Example:** Request IP address and its response

Request:

```
http://192.168.0.123/cgi-bin/admin/getparam.cgi?network_ipaddress
```

Response:

```
HTTP/1.0 200 OK\r\n
Content-Type: text/html\r\n
Context-Length: 33\r\n
\r\n
network.ipaddress=192.168.0.123\r\n
```



## 6. Set Server Parameter Values

**Note:** The access right depends on the URL directory.

**Method:** GET/POST

Syntax:

```
http://<servername>/cgi-bin/<anonymous>/setparam.cgi? <parameter>=<value>
[&<parameter>=<value>...][&update=<value>][&return=<return page>]
```

```
http://<servername>/cgi-bin/<viewer>/setparam.cgi? <parameter>=<value>
[&<parameter>=<value>...][&update=<value>] [&return=<return page>]
```

```
http://<servername>/cgi-bin/<operator>/setparam.cgi? <parameter>=<value>
[&<parameter>=<value>...][&update=<value>] [&return=<return page>]
```

```
http://<servername>/cgi-bin/<admin>/setparam.cgi? <parameter>=<value>
[&<parameter>=<value>...][&update=<value>] [&return=<return page>]
```

PARAMETER	VALUE	DESCRIPTION
<b>&lt;group&gt;_&lt;name&gt;</b>	value to assigned	Assign <value> to the parameter <group>_<name>.
<b>update</b>	<boolean>	Set to 1 to update all fields (no need to update parameter in each group).
<b>return</b>	<return page>	Redirect to the page <return page> after the parameter is assigned. The <return page> can be a full URL path or relative path according to the current path. If you omit this parameter, it will redirect to an empty page.  (Note: The return page can be a general HTML file (.htm, .html) or a VIVOTEK server script executable (.vspx) file. It cannot be a CGI command or have any extra parameters. This parameter must be placed at the end of the parameter list

Return:

```
HTTP/1.0 200 OK\r\n
Content-Type: text/html\r\n
Context-Length: <length>\r\n
\r\n
<parameter pair>
```

where <parameter pair> is

<parameter>=<value>\r\n

[<parameter pair>]

Only the parameters that you set and are readable will be returned.

**Example:** Set the IP address of server to 192.168.0.123:

Request:

[http://myserver/cgi-bin/admin/setparam.cgi?network\\_ipaddress=192.168.0.123](http://myserver/cgi-bin/admin/setparam.cgi?network_ipaddress=192.168.0.123)

Response:

HTTP/1.0 200 OK\r\n

Content-Type: text/html\r\n

Content-Length: 33\r\n

\r\n

network.ipaddress=192.168.0.123\r\n

## 7. Available parameters on the server

Valid values:

VALID VALUES	DESCRIPTION
string[<n>]	Text strings shorter than `n` characters. The characters `; , < , > , &` are invalid.
string[n~m]	Text strings longer than `n` characters and shorter than `m` characters. The characters `; , < , > , &` are invalid.
password[<n>]	The same as string but displays `*` instead.
integer	Any number between $(-2^{31} - 1)$ and $(2^{31} - 1)$ .
positive integer	Any number between 0 and $(2^{32} - 1)$ .
<m> ~ <n>	Any number between `m` and `n`.
domain name[<n>]	A string limited to a domain name shorter than `n` characters (eg. www.ibm.com).
email address [ <n> ]	A string limited to an email address shorter than `n` characters (eg. joe@www.ibm.com).
ip address	A string limited to an IP address (eg. 192.168.1.1).
mac address	A string limited to contain a MAC address without hyphens or colons.
boolean	A boolean value of 1 or 0 represents [Yes or No], [True or False], [Enable or Disable].
<value1>, <value2>, <value3>, ...	Enumeration. Only given values are valid.
blank	A blank string.

everything inside <>	A description
integer primary key	SQLite data type. A 32-bit signed integer. The value is assigned a unique integer by the server.
text	SQLite data type. The value is a text string, stored using the database encoding (UTF-8, UTF-16BE or UTF-16-LE).
coordinate	x, y coordinate (eg. 0,0)
window size	window width and height (eg. 800x600)

NOTE: The camera should not be restarted when parameters are changed.

## 7.1 system

Group: **system**

NAME	VALUE	DEFAULT	SECURITY (get/set)	DESCRIPTION
hostname	string[40]	Mega-Pixel Network Camera	1/6	Host name of server (Network Camera, Wireless Network Camera, Video Server, Wireless Video Server).
ledoff	<boolean>	1	6/6	Turn on (0) or turn off (1) all led indicators.
date	<YYYY/MM/ DD>, keep, auto	<current date>	6/6	Current date of system. Set to 'keep' to keep date unchanged. Set to 'auto' to use NTP to synchronize date.
time	<hh:mm:s s>, keep, auto	<current time>	6/6	Current time of the system. Set to 'keep' to keep time unchanged. Set to 'auto' to use NTP to synchronize time.
datetime	<MMDDhh mmYYYY.ss >	<blank>	6/6	Another current time format of the system.
ntp	<domain name>, <ip address>, <blank>	<blank>	6/6	NTP server. *Do not use "skip to invoke default server" for default value.

timezoneindex	-489 ~ 529	320	6/6	<p>Indicate timezone and area.</p> <p>-480: GMT-12:00 Eniwetok, Kwajalein</p> <p>-440: GMT-11:00 Midway Island, Samoa</p> <p>-400: GMT-10:00 Hawaii</p> <p>-360: GMT-09:00 Alaska</p> <p>-320: GMT-08:00 Las Vegas, San_Francisco, Vancouver</p> <p>-280: GMT-07:00 Mountain Time, Denver</p> <p>-281: GMT-07:00 Arizona</p> <p>-240: GMT-06:00 Central America, Central Time, Mexico City, Saskatchewan</p> <p>-200: GMT-05:00 Eastern Time, New York, Toronto</p> <p>-201: GMT-05:00 Bogota, Lima, Quito, Indiana</p> <p>-180: GMT-04:30 Caracas</p> <p>-160: GMT-04:00 Atlantic Time, Canada, La Paz, Santiago</p> <p>-140: GMT-03:30 Newfoundland</p> <p>-120: GMT-03:00 Brasilia, Buenos Aires, Georgetown, Greenland</p> <p>-80: GMT-02:00 Mid-Atlantic</p> <p>-40: GMT-01:00 Azores, Cape_Verde_IS.</p> <p>0: GMT Casablanca, Greenwich Mean Time: Dublin, Edinburgh, Lisbon, London</p> <p>40: GMT 01:00 Amsterdam, Berlin, Rome, Stockholm, Vienna, Madrid, Paris</p> <p>41: GMT 01:00 Warsaw,</p>
---------------	------------	-----	-----	---

				<p>Budapest, Bern</p> <p>80: GMT 02:00 Athens, Helsinki, Istanbul, Riga</p> <p>81: GMT 02:00 Cairo</p> <p>82: GMT 02:00 Lebanon, Minsk</p> <p>83: GMT 02:00 Israel</p> <p>120: GMT 03:00 Baghdad, Kuwait, Riyadh, Moscow, St. Petersburg, Nairobi</p> <p>121: GMT 03:00 Iraq</p> <p>140: GMT 03:30 Tehran</p> <p>160: GMT 04:00 Abu Dhabi, Muscat, Baku, Tbilisi, Yerevan</p> <p>180: GMT 04:30 Kabul</p> <p>200: GMT 05:00 Ekaterinburg, Islamabad, Karachi, Tashkent</p> <p>220: GMT 05:30 Calcutta, Chennai, Mumbai, New Delhi</p> <p>230: GMT 05:45 Kathmandu</p> <p>240: GMT 06:00 Almaty, Novosibirsk, Astana, Dhaka, Sri Jayawardenepura</p> <p>260: GMT 06:30 Rangoon</p> <p>280: GMT 07:00 Bangkok, Hanoi, Jakarta, Krasnoyarsk</p> <p>320: GMT 08:00 Beijing, Chongqing, Hong Kong, Kuala Lumpur, Singapore, Taipei</p> <p>360: GMT 09:00 Osaka, Sapporo, Tokyo, Seoul, Yakutsk</p> <p>380: GMT 09:30 Adelaide, Darwin</p> <p>400: GMT 10:00 Brisbane, Canberra, Melbourne, Sydney, Guam, Vladivostok</p> <p>440: GMT 11:00 Magadan,</p>
--	--	--	--	--

				Solomon Is., New Caledonia 480: GMT 12:00 Aucklan, Wellington, Fiji, Kamchatka, Marshall Is. 520: GMT 13:00 Nuku'Alofa
daylight_enable	<boolean>	0	6/6	Enable automatic daylight saving time in time zone.
daylight_dstactualmode	<boolean>	1	6/7	Check if current time is under daylight saving time. (Used internally)
daylight_auto_begintime	string[19]	NONE	6/7	Display the current daylight saving start time.
daylight_auto_endtime	string[19]	NONE	6/7	Display the current daylight saving end time.
daylight_timezones	string	,-360,-320, -280,-240, -241,-200, -201,-160, -140,-120, -80,-40,0, 40,41,80, 81,82,83, 120,140, 380,400,480	6/6	List time zone index which support daylight saving time.
updateinterval	0, 3600, 86400, 604800, 2592000	0	6/6	0 to Disable automatic time adjustment, otherwise, it indicates the seconds between NTP automatic update intervals.
restore	0, <positive integer>	N/A	7/6	Restore the system parameters to default values after <value> seconds.
reset	0, <positive integer>	N/A	7/6	Restart the server after <value> seconds if <value> is non-negative.
restoreexceptnet	0, <positive integer>	N/A	7/6	Restore the system parameters to default values except (ipaddress, subnet, router, dns1, dns2, pppoe).

				<p>This command can cooperate with other "restoreexceptXYZ" commands. When cooperating with others, the system parameters will be restored to the default value except for a union of the combined results.</p>
restoreexceptdst	0, <positive integer>	N/A	7/6	<p>Restore the system parameters to default values except all daylight saving time settings.</p> <p>This command can cooperate with other "restoreexceptXYZ" commands. When cooperating with others, the system parameters will be restored to default values except for a union of combined results.</p>
restoreexceptlang	0, <positive integer>	N/A	7/6	<p>Restore the system parameters to default values except the custom language file the user has uploaded.</p> <p>This command can cooperate with other "restoreexceptXYZ" commands. When cooperating with others, the system parameters will be restored to the default value except for a union of the combined results.</p>

## 7.1.1 system.info

Subgroup of **system: info** (The fields in this group are unchangeable.)

NAME	VALUE	DEFAULT	SECURITY (get/set)	DESCRIPTION
modelName	string[40]	FD8335H	0/7	Internal model name of the server (eg. IP7139)
extendedmodelName	string[40]	FD8335H	0/7	ODM specific model name of server (eg. DCS-5610). If it is not an ODM model, this field will be equal to "modelName"
serialnumber	<mac address>	<product mac address>	0/7	12 characters MAC address (without hyphens).
firmwareversion	string[40]	<product dependent >	0/7	Firmware version, including model, company, and version number in the format: <MODEL-BRAND-VERSION>
language_count	<integer>	9	0/7	Number of webpage languages available on the server.
language_i<0~(count-1)>	string[16]	<product dependent >	0/7	Available language lists.
customlanguage_maxcount	<integer>	1	0/6	Maximum number of custom languages supported on the server.
customlanguage_count	<integer>	0	0/6	Number of custom languages which have been uploaded to the server.
customlanguage_i<0~(maxcount-1)>	string	<blank>	0/6	Custom language name.



## 7.2 status

Group: **status**

NAME	VALUE	DEFAULT	SECURITY (get/set)	DESCRIPTION
di_i<0~(ndi-1)>	<boolean>	0	1/7	0 => Inactive, normal 1 => Active, triggered (capability.ndi > 0)
do_i<0~(ndo-1)>	<boolean>	0	1/7	0 => Inactive, normal 1 => Active, triggered (capability.ndo > 0)
daynight	day, night	<product dependent>	7/7	Current status of day, night.
onlinenum_rtsp	integer	0	6/7	Current number of RTSP connections.
onlinenum_httppush	integer	0	6/7	Current number of HTTP push server connections.
eth_i0	<string>	<product dependent>	1/7	Get network information from mii-tool.
vi_i<0~(nvi-1)>	<boolean>	0	1/7	Virtual input 0 => Inactive 1 => Active (capability.nvi > 0)

## 7.3 digital input behavior define

Group: **di\_i<0~(ndi-1)>** (capability.ndi > 0)

NAME	VALUE	DEFAULT	SECURITY (get/set)	DESCRIPTION
normalstate	high, low	high	1/1	Indicates open circuit or closed circuit (inactive status)

## 7.4 digital output behavior define

Group: **do\_i<0~(ndo-1)>** (*capability.ndo > 0*)

NAME	VALUE	DEFAULT	SECURITY (get/set)	DESCRIPTION
normalstate	open, grounded	open	1/1	Indicate open circuit or closed circuit (inactive status)

## 7.5 security

Group: security

NAME	VALUE	DEFAULT	SECURITY (get/set)	DESCRIPTION
privilege_do	view, operator, admin	operator	6/6	Indicate which privileges and above can control digital output ( <i>capability.ndo &gt; 0</i> )
privilege_camctrl	view, operator, admin	view	6/6	Indicate which privileges and above can control PTZ ( <i>capability.ptzenabled &gt; 0</i> or <i>capability.eptz &gt; 0</i> )
user_i0_name	string[64]	root	6/7	User name of root
user_i<1~20>_name	string[64]	<blank>	6/7	User name
user_i0_pass	password[64]	<blank>	6/6	Root password
user_i<1~20>_pass	password[64]	<blank>	7/6	User password
user_i0_privilege	viewer, operator, admin	admin	6/7	Root privilege
user_i<1~20>_privilege	viewer, operator, admin	<blank>	6/6	User privilege

## 7.6 network

Group: **network**

NAME	VALUE	DEFAULT	SECURITY (get/set)	DESCRIPTION
preprocesses	<positive integer>	<blank>	7/6	<p>An 32-bit integer, each bit can be set separately as follows:</p> <ul style="list-style-type: none"> <li>Bit 0 =&gt; HTTP service;</li> <li>Bit 1=&gt; HTTPS service;</li> <li>Bit 2=&gt; FTP service;</li> <li>Bit 3 =&gt; Two way audio and RTSP Streaming service;</li> </ul> <p>To stop service before changing its port settings. It's <b>recommended</b> to set this parameter when change a service port to the port occupied by another service currently. Otherwise, the service may fail. Stopped service will auto-start after changing port settings.</p> <p>Ex:</p> <p>Change HTTP port from 80 to 5556, and change RTP port for video from 5556 to 20480. Then, set preprocess=9 to stop both service first.</p> <p>"/cgi-bin/admin/setparam.cgi?network_preprocess=9&amp;network_http_port=5556&amp; network_rtp_videoport=20480"</p>
type	lan, pppoe	lan	6/6	Network connection type.
resetip	<boolean>	1	6/6	<p>1 =&gt; Get ipaddress, subnet, router, dns1, dns2 from DHCP server at next reboot.</p> <p>0 =&gt; Use preset ipaddress, subnet, router, dns1, and dns2.</p>
ipaddress	<ip address>	<product dependent>	6/6	IP address of server.
subnet	<ip address>	<blank>	6/6	Subnet mask.
router	<ip	<blank>	6/6	Default gateway.

	address>			
dns1	<ip address>	<blank>	6/6	Primary DNS server.
dns2	<ip address>	<blank>	6/6	Secondary DNS server.
wins1	<ip address>	<blank>	6/6	Primary WINS server.
wins2	<ip address>	<blank>	6/6	Secondary WINS server.

## 7.6.1 802.1x

Subgroup of **network: ieee8021x** (capability.protocol.ieee8021x > 0)

NAME	VALUE	DEFAULT	SECURITY (get/set)	DESCRIPTION
enable	<boolean>	0	6/6	Enable/disable IEEE 802.1x
eapmethod	eap-peap, eap-tls	eap-peap	6/6	Selected EAP method
identity_peap	String[64]	<blank>	6/6	PEAP identity
identity_tls	String[64]	<blank>	6/6	TLS identity
password	String[254]	<blank>	6/6	Password for TLS
privatekeypassword	String[254]	<blank>	6/6	Password for PEAP
ca_exist	<boolean>	0	6/6	CA installed flag
ca_time	<integer>	0	6/7	CA installed time. Represented in EPOCH
ca_size	<integer>	0	6/7	CA file size (in bytes)
certificate_exist	<boolean>	0	6/6	Certificate installed flag (for TLS)
certificate_time	<integer>	0	6/7	Certificate installed time. Represented in EPOCH
certificate_size	<integer>	0	6/7	Certificate file size (in bytes)
privatekey_exist	<boolean>	0	6/6	Private key installed flag (for TLS)
privatekey_time	<integer>	0	6/7	Private key installed time. Represented in EPOCH
privatekey_size	<integer>	0	6/7	Private key file size (in bytes)

## 7.6.2 QOS

Subgroup of **network: qos\_cos** (capability.protocol.qos.cos > 0)

NAME	VALUE	DEFAULT	SECURITY (get/set)	DESCRIPTION
enable	<boolean>	0	6/6	Enable/disable CoS (IEEE 802.1p)
vlanid	1~4095	1	6/6	VLAN ID
video	0~7	0	6/6	Video channel for CoS
audio	0~7	0	6/6	Audio channel for CoS (capability.naudioout > 0)
eventalarm	0~7	0	6/6	Event/alarm channel for CoS
management	0~7	0	6/6	Management channel for CoS
eventtunnel	0~7	0	6/6	Event/Control channel for CoS

Subgroup of **network: qos\_dscp** (capability.protocol.qos.dscp > 0)

NAME	VALUE	DEFAULT	SECURITY (get/set)	DESCRIPTION
enable	<boolean>	0	6/6	Enable/disable DSCP
video	0~63	0	6/6	Video channel for DSCP
audio	0~63	0	6/6	Audio channel for DSCP (capability.naudioout > 0)
eventalarm	0~63	0	6/6	Event/alarm channel for DSCP
management	0~63	0	6/6	Management channel for DSCP
eventtunnel	0~63	0	6/6	Event/Control channel for DSCP

## 7.6.3 IPV6

Subgroup of **network: ipv6** (capability.protocol.ipv6 > 0)

NAME	VALUE	DEFAULT	SECURITY (get/set)	DESCRIPTION
enable	<boolean>	0	6/6	Enable IPv6.
addonipaddress	<ip address>	<blank>	6/6	IPv6 IP address.
addonprefixlen	0~128	64	6/6	IPv6 prefix length.
addonrouter	<ip address>	<blank>	6/6	IPv6 router address.
addondns	<ip address>	<blank>	6/6	IPv6 DNS address.
allowoptional	<boolean>	0	6/6	Allow manually setup of IP address setting.

## 7.6.4 FTP

Subgroup of **network**: **ftp**

NAME	VALUE	DEFAULT	SECURITY (get/set)	DESCRIPTION
port	21, 1025~65535	21	6/6	Local ftp server port.

## 7.6.5 HTTP

Subgroup of **network**: **http**

NAME	VALUE	DEFAULT	SECURITY (get/set)	DESCRIPTION
port	80, 1025 ~ 65535	80	1/6	HTTP port.
alternateport	1025~65535	8080	6/6	Alternate HTTP port.
authmode	basic, digest	basic	1/6	HTTP authentication mode.
s0_accessname	string[32]	video.mjpg	1/6	HTTP server push access name for stream 1. (capability.protocol.spush_mjpg eg =1 and capability.nmediastream > 0)
s1_accessname	string[32]	video2.mjpg	1/6	HTTP server push access name for stream 2. (capability.protocol.spush_mjpg eg =1 and capability.nmediastream > 1)
anonymousviewing	<boolean>	0	1/6	Enable anonymous streaming viewing.

## 7.6.6 HTTPS port

Subgroup of **network**: **https\_port** (**capability.protocol.https > 0**)

NAME	VALUE	DEFAULT	SECURITY (get/set)	DESCRIPTION
port	443, 1025 ~ 65535	443	1/6	HTTPS port.

## 7.6.7 RTSP

Subgroup of **network: rtsp** (`capability.protocol.rtsp > 0`)

NAME	VALUE	DEFAULT	SECURITY (get/set)	DESCRIPTION
port	554, 1025 ~ 65535	554	1/6	RTSP port. ( <code>capability.protocol.rtsp=1</code> )
anonymousviewing	<boolean>	0	1/6	Enable anonymous streaming viewing.
authmode	disable, basic, digest	disable	1/6	RTSP authentication mode. ( <code>capability.protocol.rtsp=1</code> )
s0_accessname	<boolean>	live.sdp	1/6	RTSP access name for stream1. ( <code>capability.protocol.rtsp=1</code> and <code>capability.nmediastream &gt; 0</code> )
s1_accessname	<boolean>	live2.sdp	1/6	RTSP access name for stream2. ( <code>capability.protocol.rtsp=1</code> and <code>capability.nmediastream &gt; 1</code> )
s0_audiotrack	<boolean>	0	1/6	Enable audio for stream1.
s1_audiotrack	<boolean>	0	1/6	Enable audio for stream2.

### 7.6.7.1 RTSP multicast

Subgroup of **network\_rtsp\_s<0~(n-1)>: multicast**, n is stream count (`capability.protocol.rtp.multicast > 0`)

NAME	VALUE	DEFAULT	SECURITY (get/set)	DESCRIPTION
alwaysmulticast	<boolean>	0	4/4	Enable always multicast.
ipaddress	<ip address>	For n=0, 239.128.1.99 For n=1, 239.128.1.100, and so on.	4/4	Multicast IP address.
videoport	1025 ~ 65535	5560+n*2	4/4	Multicast video port.
audioport	1025 ~ 65535	5562+n*2	4/4	Multicast audio port. ( <code>capability.naudioout &gt; 0</code> )
tll	1 ~ 255	15	4/4	Multicast time to live value.

## 7.6.8 SIP port

Subgroup of **network**: **sip** (capability.protocol.sip > 0)

NAME	VALUE	DEFAULT	SECURITY (get/set)	DESCRIPTION
port	1025 ~ 65535	5060	1/6	SIP port.

## 7.6.9 RTP port

Subgroup of **network**: **rtp**

NAME	VALUE	DEFAULT	SECURITY (get/set)	DESCRIPTION
videoport	1025 ~ 65535	5556	6/6	Video channel port for RTP. (capability.protocol.rtp_unicast=1)
audioprot	1025 ~ 65535	5558	6/6	Audio channel port for RTP. (capability.protocol.rtp_unicast=1)

## 7.6.10 PPPoE

Subgroup of **network**: **pppoe** (capability.protocol.pppoe > 0)

NAME	VALUE	DEFAULT	SECURITY (get/set)	DESCRIPTION
user	string[128]	<blank>	6/6	PPPoE account user name.
pass	password[64]	<blank>	6/6	PPPoE account password.

## 7.7 IP Filter

Group: ipfilter

NAME	VALUE	DEFAULT	SECURITY (get/set)	DESCRIPTION
enable	<boolean>	0	6/6	Enable access list filtering.
admin_enable	<boolean>	0	6/6	Enable administrator IP address.
admin_ip	String[44]	<blank>	6/6	Administrator IP address.
maxconnection	1~10	10	6/6	Maximum number of concurrent streaming connection(s).
type	0, 1	1	6/6	Ipfilter policy :



				0 => allow 1 => deny
ipv4list_j<0~9>	Single address: <ip address> Network address: <ip address / network mask> Range address: <start ip address - end ip address>	<blank>	6/6	IPv4 address list.
ipv6list_j<0~9>	String[44]	<blank>	6/6	IPv6 address list.

## 7.8 Video input

Group: **videoin**

NAME	VALUE	DEFAULT	SECURITY (get/set)	DESCRIPTION
cmosfreq	50, 60	60	4/4	CMOS frequency. (capability.videoin.type=2)
whitebalance	auto, manual	auto	4/4	"auto" indicates auto white balance. "manual" indicates keep current value.
exposurelevel	0~8	4	4/4	Exposure level
enablewdr	<boolean>	0	4/4	Enable/disable wild dynamic range.
color	0, 1	1	4/4	0 => monochrome 1 => color
flip	<boolean>	0	4/4	Flip the image.
mirror	<boolean>	0	4/4	Mirror the image.
ptzstatus	<integer>	2	1/7	A 32-bit integer, each bit can be set separately as follows: Bit 0 => Support camera control function; 0(not support), 1(support) Bit 1 => <b>Built-in</b> or <b>external</b> camera; 0 (external), 1(built-in)

				Bit 2 => Support <b>pan</b> operation; 0(not support), 1(support) Bit 3 => Support <b>tilt</b> operation; 0(not support), 1(support) Bit 4 => Support <b>zoom</b> operation; 0(not support), 1(support) Bit 5 => Support <b>focus</b> operation; 0(not support), 1(support)
text	string[16]	<blank>	1/4	Enclose caption.
imprnttimestamp	<boolean>	0	4/4	Overlay time stamp on video.
enablepreview	<boolean>	0	1/4	Usage for UI of exposure settings. Preview settings of video profile.

## 7.8.1 Video input setting per channel

Group: **videoin\_c<0~(n-1)>** for n channel products, and m is stream number

NAME	VALUE	DEFAULT	SECURITY (get/set)	DESCRIPTION
cmosfreq	50, 60	60	4/4	CMOS frequency. (capability.videoin.type=2)
whitebalance	auto, manual	auto	4/4	"auto" indicates auto white balance. "manual" indicates keep current value.
exposurelevel	0~8	4	4/4	Exposure level
maxgain	0~5	2	4/4	Max gain: 0 : 2x 1 : 4x 2 : 8x 3 : 16x 4 : 32x 5 : 64x
color	0, 1	1	4/4	0 => monochrome 1 => color
flip	<boolean>	0	4/4	Flip the image.
mirror	<boolean>	0	4/4	Mirror the image.

ptzstatus	<integer>	2	1/7	A 32-bit integer, each bit can be set separately as follows: Bit 0 => Support camera control function; 0(not support), 1(support) Bit 1 => <b>Built-in</b> or <b>external</b> camera; 0 (external), 1(built-in) Bit 2 => Support <b>pan</b> operation; 0(not support), 1(support) Bit 3 => Support <b>tilt</b> operation; 0(not support), 1(support) Bit 4 => Support <b>zoom</b> operation; 0(not support), 1(support) Bit 5 => Support <b>focus</b> operation; 0(not support), 1(support)
text	string[16]	<blank>	1/4	Enclose caption.
imprnttimestamp	<boolean>	0	4/4	Overlay time stamp on video.
enablepreview	<boolean>	0	1/4	Usage for UI of image/sensor settings. Preview settings of video profile.
s0_codecstype	mjpeg, h264	H264	1/4	Video codec type.
s1_codecstype	mpeg4, mjpeg, h264	H264	1/4	Video codec type.
s<0~(m-1)>_resolution	Reference capability_videoin_resolution	1280x800	1/4	Video resolution in pixels.
s<0~(m-1)>_mpeg4_intraperiod	250, 500, 1000, 2000, 3000, 4000	1000	4/4	Intra frame period in milliseconds.
s<0~(m-1)>_mpeg4_ratecontrolmode	cbr, vbr	Vbr	4/4	cbr, constant bitrate vbr, fix quality
s<0~(m-1)>_mpeg4_quant	1~5 99, 100	3	4/4	Quality of video when choosing vbr in "ratecontrolmode". 99 is the customized manual input setting. 1 = worst quality, 5 = best quality.

				100 is percentage mode.
s<0~(m-1)>_mpeg4_qvalue	1~31	7	4/4	Manual video quality level input. (s<0~(m-1)>_mpeg4_quant = 99)
s<0~(m-1)>_mpeg4_qpercent	1~100	29	4/4	Manual video quality level input. (s<0~(m-1)>_mpeg4_quant = 100)
s<0~(m-1)>_mpeg4_bitrate	1000~16000000	4000000	4/4	Set bit rate in bps when choosing cbr in "ratecontrolmode".
s<0~(m-1)>_mpeg4_maxframe	1~30	30	1/4	Set maximum frame rate in fps (for MPEG-4).
s<0~(m-1)>_h264_intraperiod	250, 500, 1000, 2000, 3000, 4000	1000	4/4	Intra frame period in milliseconds.
s<0~(m-1)>_h264_ratecontrolmode	cbr, vbr	cbr	4/4	cbr, constant bitrate vbr, fix quality
s<0~(m-1)>_h264_quant	1~5 99, 100	3	4/4	Quality of video when choosing vbr in "ratecontrolmode". 99 is the customized manual input setting. 1 = worst quality, 5 = best quality. 100 is percentage mode.
s<0~(m-1)>_h264_qvalue	0~51	26	4/4	Manual video quality level input. (s<0~(m-1)>_h264_quant = 99)
s<0~(m-1)>_h264_qpercent	1~100	45	4/4	Manual video quality level input. (s<0~(m-1)>_h264_quant = 100)
s<0~(m-1)>_h264_bitrate	1000~16000000	4000000	4/4	Set bit rate in bps when choosing cbr in "ratecontrolmode".
s<0~(m-1)>_h264_maxframe	1~30	30	1/4	Set maximum frame rate in fps (for h264).
s<0~(m-1)>_h264_profile	0~2	2	1/4	Indicate H264 profiles 0: baseline 1: main profile 2: high profile
s<0~(m-1)>_mjpeg_quant	1~5 99, 100	3	4/4	Quality of JPEG video. 99 is the customized manual

				input setting. 1 = worst quality, 5 = best quality. 100 is percentage mode.
s<0~(m-1)>_mpeg_qvalue	2~97	50	4/4	Manual video quality level input. (s<0~(m-1)>_mpeg_quant = 99)
s<0~(m-1)>_mpeg_qpercent	1~100	49	4/4	Manual video quality level input. (s<0~(m-1)>_mpeg_quant = 100)
s<0~(m-1)>_mpeg_maxframe	1~30	30	1/4	Set maximum frame rate in fps (for JPEG).
piris_response	1~3	1	1/4	P-Iris response time
piris_position	0~50	0	4/4	P-Iris position. 0 : P-Iris open to largest 50 : P-Iris close to smallest
wdrc_mode	0~1	0	4/4	WDR enable. 0: off 1: on
wdrc_strength	0~2	1	4/4	WDR strength. 0: low 1: medium 2: high

### 7.8.1.1 Alternative video input profiles per channel

In addition to the primary setting of video input, there can be alternative profile video input setting for each channel which might be for different scene of light (daytime or nighttime).

Group: **videoin\_c0\_profile\_i<0~(m-1)>** (capability. nvideoinprofile > 0)

NAME	VALUE	DEFAULT	SECURITY (get/set)	DESCRIPTION
enable	<boolean>	0	4/4	Enable/disable this profile setting
policy	day, night, schedule	night	4/4	The mode which the profile is applied to.
begintime	hh:mm	18:00	4/4	Begin time of schedule mode.
endtime	hh:mm	06:00	4/4	End time of schedule mode.
exposurelevel	0~8	4	4/4	Exposure level
maxgain	0~5	2	4/4	Max gain:

				0 : 2x 1 : 4x 2 : 8x 3 : 16x 4 : 32x 5 : 64x
whitebalance	auto, manual	auto	4/4	"auto" indicates auto white balance. "manual" indicates keep current value.
piris_response	1~3	1	4/4	P-Iris response time
piris_position	0~50	0	1/4	P-Iris position. 0 : P-Iris open to largest 50 : P-Iris close to smallest
wdr_mode	0~1	0	4/4	WDR enable. 0: off 1: on
wdr_strength	0~2	1	4/4	WDR strength. 0: low 1: medium 2: high

## 7.9 Video input preview

The temporary settings for video preview

Group: videoinpreview

NAME	VALUE	DEFAULT	SECURITY (get/set)	DESCRIPTION
exposuremode	auto, fixed	auto	4/4	Exposure Mode
exposurelevel	0~8	4	4/4	Exposure level
piris_response	1~3	1	1/4	P-Iris response time
piris_position	0~50	0	4/4	P-Iris position. 0 : P-Iris open to largest 50 : P-Iris close to smallest
wdr_mode	0~1	0	4/4	WDR enable. 0: off 1: on
wdr_strength	0~2	1	4/4	WDR strength. 0: low 1: medium

				2: high
maxgain	0~5	100	4/4	Max gain: 0 : 2x 1 : 4x 2 : 8x 3 : 16x 4 : 32x 5 : 64x

## 7.10 IR cut control

Group: **ircutcontrol** (capability.nvideoinprofile > 0)

NAME	VALUE	DEFAULT	SECURITY (get/set)	DESCRIPTION
mode	auto, day, night, di0, di1, di2, schedule	auto	6/6	Set IR cut control mode
daymodebegin time	00:00~23:59	07:00	6/6	Day mode begin time
daymodeend time	00:00~23:59	18:00	6/6	Day mod end time
disableirled	<boolean>	0	6/6	Disable built-in IR led
enableextled	<boolean>	0	1/6	Enable external IR led
bwmode	<boolean>	1	6/6	Switch to B/W in night mode if enabled
sensitivity	low, normal, high	normal	6/6	Sensitivity of light sensor

## 7.11 Image setting per channel

Group: **image\_c<0~(n-1)>** for n channel products

NAME	VALUE	DEFAULT	SECURITY (get/set)	DESCRIPTION
brightness	-5~5	-5	4/4	Adjust brightness of image according to mode settings.
saturation	-5~5	0	4/4	Adjust saturation of image according to mode settings.
contrast	-5~5	0	4/4	Adjust contrast of image according to mode settings.
sharpness	-3~3	0	4/4	Adjust sharpness of image according to mode settings.
gammacurve	0,45,50,60,70,80,90,100	0	4/4	Gamma curve.
lowlightmode	<boolean>	1	4/4	Enable/disable low light mode.
profile_i0_enable	<boolean>	0	4/4	Enable/disable this profile setting
profile_i0_policy	day, night, schedule	night	4/4	The mode which the profile is applied to.
profile_i0_begintime	hh:mm	18:00	4/4	Begin time of schedule mode.
profile_i0_endtime	hh:mm	06:00	4/4	End time of schedule mode.
profile_i0_brightness	-5~5	-5	4/4	Adjust brightness of image according to mode settings.
profile_i0_saturation	-5~5	0	4/4	Adjust saturation of image according to mode settings.
profile_i0_contrast	-5~5	0	4/4	Adjust contrast of image according to mode settings.
profile_i0_sharpness	-3~3	0	4/4	Adjust sharpness of



				image according to mode settings.
profile_i0_gammacurve	0,45,50,60,70,80,90,100	0	4/4	Gamma curve
profile_i0_lowlightmode	<boolean>	0	4/4	Enable/disable low light mode.

## 7.12 Image setting for preview

Group: **imagepreview\_c<0~(n-1)>** for n channel products

NAME	VALUE	DEFAULT	SECURITY (get/set)	DESCRIPTION
brightness	-5~5	-5	4/4	Adjust brightness of image according to mode settings.
saturation	-5~5	0	4/4	Adjust saturation of image according to mode settings.
contrast	-5 ~ 5	0	4/4	Adjust contrast of image according to mode settings.
sharpness	-3~3	0	4/4	Adjust sharpness of image according to mode settings.
gammacurve	0~100	0	4/4	Gamma curve
lowlightmode	<boolean>	0	4/4	Enable/disable low light mode.

Group: imagepreview

NAME	VALUE	DEFAULT	SECURITY (get/set)	DESCRIPTION
videoin_whitebalance	auto, manual	auto	4/4	Preview of adjusting white balance of image according to mode settings
videoin_restoreatwb	0, 1~	0	4/4	Restore of adjusting white balance of image according to mode settings

## 7.13 Exposure window setting per channel

Group: **exposure\_c<0~(n-1)>** for n channel products

NAME	VALUE	DEFAULT	SECURITY (get/set)	DESCRIPTION
mode	auto, custom	auto	4/4	The mode indicates how to decide the exposure. auto: Use full view as the only one exposure window. custom: Use customized exposure window.
win_i0_enable	<boolean>	0	4/4	Enable or disable the window.
win_i0_home	<coordinate>	(150,110)	4/4	Left-top corner coordinate of the window.
win_i0_size	<window size>	(100x75)	4/4	Width and height of the window.

Group: **exposure\_c<0~(n-1)>\_profile** for m profile and n channel product

NAME	VALUE	DEFAULT	SECURITY (get/set)	DESCRIPTION
i<0~(m-1)>_mode	auto, custom	auto	4/4	The mode indicates how to decide the exposure. auto: Use full view as the only one exposure window. custom: Use customized exposure window.
i<0~(m-1)>_win_i0_enable	<boolean>	0	4/4	Enable or disable the window.
i<0~(m-1)>_win_i0_home	<coordinate>	(150,110)	4/4	Left-top corner coordinate of the window.
i<0~(m-1)>_win_i0_size	<window size>	(100x75)	4/4	Width and height of the window.

## 7.14 Audio input per channel

Group: **audioin\_c<0~(n-1)>** for n channel products (**capability.audioin>0**)

NAME	VALUE	DEFAULT	SECURITY (get/set)	DESCRIPTION
mute	0, 1	1	4/4	Enable audio mute.
gain	1,5,9,13,17,21,25, 29,33,37,41,45,49, 53,57,61	17	4/4	Gain of input. (audioin_c<0~(n-1)>_source = linein)
s<0~(m-1)>_codectyp e	aac4, gamr, g711	aac4	4/4	Set audio codec type for input.
s<0~(m-1)>_aac4_bitr ate	16000, 32000, 48000, 64000, 96000, 128000	16000	4/4	Set AAC4 bitrate in bps.
s<0~(m-1)>_gamr_bitr ate	4750, 5150, 5900, 6700, 7400, 7950, 10200, 12200	12200	4/4	Set AMR bitrate in bps.
s<0~(m-1)>_g711_mo de	pcmu, pcma	pcmu	4/4	Set G.711 mode.

## 7.15 Motion detection settings

Group: **motion\_c<0~(n-1)>** for n channel product

NAME	VALUE	DEFAULT	SECURITY (get/set)	DESCRIPTION
enable	<boolean>	0	4/4	Enable motion detection.
win_i<0~2>_enable	<boolean>	0	4/4	Enable motion window 1~3.
win_i<0~2>_name	string[14]	<blank>	4/4	Name of motion window 1~3.
win_i<0~2>_left	0 ~ 320	0	4/4	Left coordinate of window position.
win_i<0~2>_top	0 ~ 240	0	4/4	Top coordinate of window

				position.
win_i<0~2>_width	0 ~ 320	0	4/4	Width of motion detection window.
win_i<0~2>_height	0 ~ 240	0	4/4	Height of motion detection window.
win_i<0~2>_objsize	0 ~ 100	0	4/4	Percent of motion detection window.
win_i<0~2>_sensitivity	0 ~ 100	0	4/4	Sensitivity of motion detection window.

Group: **motion\_c<0~(n-1)> profile** for m profile and n channel product (capability.nmotionprofile > 0)

NAME	VALUE	DEFAULT	SECURITY (get/set)	DESCRIPTION
i<0~(m-1)>_enable	<boolean>	0	4/4	Enable profile 1 ~ (m-1).
i<0~(m-1)>_policy	day, night, schedule	night	4/4	The mode which the profile is applied to.
i<0~(m-1)>_begintime	hh:mm	18:00	4/4	Begin time of schedule mode.
i<0~(m-1)>_endtime	hh:mm	06:00	4/4	End time of schedule mode.
i<0~(m-1)>_win_i<0~2>_enable	<boolean>	0	4/4	Enable motion window.
i<0~(m-1)>_win_i<0~2>_name	string[14]	<blank>	4/4	Name of motion window.
i<0~(m-1)>_win_i<0~2>_left	0 ~ 320	0	4/4	Left coordinate of window position.
i<0~(m-1)>_win_i<0~2>_top	0 ~ 240	0	4/4	Top coordinate of window position.
i<0~(m-1)>_win_i<0~2>_width	0 ~ 320	0	4/4	Width of motion detection window.
i<0~(m-1)>_win_i<0~2>_height	0 ~ 240	0	4/4	Height of motion detection window.

$i<0\sim(m-1)>_{\text{win}}i<0\sim 2>_{\text{objsize}}$	0 ~ 100	0	4/4	Percent of motion detection window.
$i<0\sim(m-1)>_{\text{win}}i<0\sim 2>_{\text{sensitivity}}$	0 ~ 100	0	4/4	Sensitivity of motion detection window.

## 7.16 Tempering detection settings

Group: **tampering\_c<0~(n-1)>** for n channel product (**capability.tampering > 0**)

NAME	VALUE	DEFAULT	SECURITY (get/set)	DESCRIPTION
enable	<boolean>	0	4/4	Enable or disable tamper detection.
threshold	0 ~ 255	32	4/4	Threshold of tamper detection.
duration	10 ~ 600	10	4/4	If tampering value exceeds the 'threshold' for more than 'duration' second(s), then tamper detection is triggered.

## 7.17 DDNS

Group: **ddns** (**capability.ddns > 0**)

NAME	VALUE	DEFAULT	SECURITY (get/set)	DESCRIPTION
enable	<boolean>	0	6/6	Enable or disable the dynamic DNS.
provider	Safe100, DyndnsDynamic, DyndnsCustom, TZO, DHS, DynInterfree, CustomSafe100, PeanutHull	DyndnsDynamic amic	6/6	Safe100 => safe100.net DyndnsDynamic => dyndns.org (dynamic) DyndnsCustom => dyndns.org (custom) TZO => tzo.com DHS => dhs.org DynInterfree => dyn-interfree.it CustomSafe100 => Custom server using safe100 method PeanutHull => PeanutHull
<provider>_hostname	string[128]	<blank>	6/6	Your DDNS hostname.
<provider>_us	string[64]	<blank>	6/6	Your user name or email to login to

ernameemail				the DDNS service provider
<provider>_passwordkey	string[64]	<blank>	6/6	Your password or key to login to the DDNS service provider.
<provider>_servername	string[128]	<blank>	6/6	The server name for safe100. (This field only exists if the provider is customsafel00)

## 7.18 Express link

Group: expresslink

PARAMETER	VALUE	Default	SECURITY (get/set)	DESCRIPTION
enable	<boolean>	0	6/6	Enable or disable express link.
state	onlycheck, onlyoffline, checkonline, badnetwork	NULL	6/6	Camera will check the status of network environment and express link URL
url	string[64]	NULL	6/6	The url user define to link to camera

## 7.19 UPnP presentation

Group: upnppresentation

NAME	VALUE	DEFAULT	SECURITY (get/set)	DESCRIPTION
enable	<boolean>	1	6/6	Enable or disable the UPnP presentation service.

## 7.20 UPnP port forwarding

Group: upnpportforwarding

NAME	VALUE	DEFAULT	SECURITY (get/set)	DESCRIPTION
enable	<boolean>	0	6/6	Enable or disable the UPnP port forwarding service.
upnppnatstatus	0~3	0	6/7	The status of UPnP port forwarding, used internally. 0 = OK, 1 = FAIL, 2 = no IGD router, 3 = no need for port forwarding

## 7.21 System log

Group: **syslog**

NAME	VALUE	DEFAULT	SECURITY (get/set)	DESCRIPTION
enableremotelog	<boolean>	0	6/6	Enable remote log.
serverip	<IP address>	<blank>	6/6	Log server IP address.
serverport	514, 1025~65535	514	6/6	Server port used for log.
level	0~7	6	6/6	Levels used to distinguish the importance of the information: 0: LOG_EMERG 1: LOG_ALERT 2: LOG_CRIT 3: LOG_ERR 4: LOG_WARNING 5: LOG_NOTICE 6: LOG_INFO 7: LOG_DEBUG
setparamlevel	0~2	0	6/6	Show log of parameter setting. 0: disable 1: Show log of parameter setting set from external. 2. Show log of parameter setting set from external and internal.

## 7.22 SNMP

Group: **snmp** (capability.snmp > 0)

NAME	VALUE	DEFAULT	SECURITY (get/set)	DESCRIPTION
v2	0~1	0	6/6	SNMP v2 enabled. 0 for disable, 1 for enable
v3	0~1	0	6/6	SNMP v3 enabled. 0 for disable, 1 for enable

secnamerw	string[31]	Private	6/6	Read/write security name
secnamero	string[31]	Public	6/6	Read only security name
authpwrw	string[8~128]	<blank>	6/6	Read/write authentication password
authpwro	string[8~128]	<blank>	6/6	Read only authentication password
authtyperw	MD5,SHA	MD5	6/6	Read/write authentication type
authtypero	MD5,SHA	MD5	6/6	Read only authentication type
encryptpwrw	string[8~128]	<blank>	6/6	Read/write passwd
encryptpwro	string[8~128]	<blank>	6/6	Read only password
encrypttyperw	DES	DES	6/6	Read/write encryption type
encrypttypero	DES	DES	6/6	Read only encryption type
rwcommunity	string[31]	Private	6/6	Read/write community
rocommunity	string[31]	Public	6/6	Read only community
syslocation	0~128	<blank>	6/6	System location
syscontact	0~128	<blank>	6/6	System contact

## 7.23 Layout configuration

Group: **layout** (New version)

NAME	VALUE	DEFAULT	SECURITY (get/set)	DESCRIPTION
logo_default	<boolean>	1	1/6	0 => Custom logo 1 => Default logo
logo_link	string[40]	<a href="http://www.vivotek.com">http://www.vivotek.com</a>	1/6	Hyperlink of the logo
logo_powerbyvvtk_hidden	<boolean>	0	1/6	0 => display the power by vivotek logo 1 => hide the power by vivotek logo
custombutton_manualtrigger_show	<boolean>	1	1/6	Show or hide manual trigger (VI) button in homepage 0 -> Hidden 1 -> Visible
theme_option	1~4	1	1/6	1~3: One of the default themes.



				4: Custom definition.
theme_color_font	string[7]	#ffffff	1/6	Font color
theme_color_configfont	string[7]	#ffffff	1/6	Font color of configuration area.
theme_color_titlefont	string[7]	#098bd6	1/6	Font color of video title.
theme_color_controlbackground	string[7]	#565656	1/6	Background color of control area.
theme_color_configbackground	string[7]	#323232	1/6	Background color of configuration area.
theme_color_videobackground	string[7]	#565656	1/6	Background color of video area.
theme_color_case	string[7]	#323232	1/6	Frame color

## 7.24 Privacy mask

Group: **privacymask\_c<0~(n-1)>** for n channel product

NAME	VALUE	DEFAULT	SECURITY (get/set)	DESCRIPTION
enable	<boolean>	0	4/4	Enable privacy mask.
win_i<0~4>_enable	<boolean>	0	4/4	Enable privacy mask window.
win_i<0~4>_name	string[40]	<blank>	4/4	Name of the privacy mask window.
win_i<0~4>_left	0 ~ 320	0	4/4	Left coordinate of window position.
win_i<0~4>_top	0 ~ 240	0	4/4	Top coordinate of window position.
win_i<0~4>_width	0 ~ 320	0	4/4	Width of privacy mask window.
win_i<0~4>_height	0 ~ 240	0	4/4	Height of privacy mask window.

## 7.25 Capability

Group: capability

NAME	VALUE	DEFAULT	SECURITY (get/set)	DESCRIPTION
api_httpversion	<string>	0100a	0/7	The HTTP API version.
bootuptime	<positive integer>	60	0/7	Server bootup time.
nir	0, <positive integer>	1	0/7	Number of IR interfaces. (Recommand to use ir for built-in IR and extir for external IR)
npir	0, <positive integer>	0	0/7	Number of PIRs.
ndi	0, <positive integer>	3	0/7	Number of digital inputs.
nvi	0, <positive integer>	3	0/7	Number of virtual inputs (manual trigger)
ndo	0, <positive integer>	1	0/7	Number of digital outputs.
naudioin	0, <positive integer>	1	0/7	Number of audio inputs.
naudioout	0, <positive integer>	1	0/7	Number of audio outputs.
nvideoin	<positive integer>	1	0/7	Number of video inputs.
nmediastream	<positive integer>	2	0/7	Number of media stream per channels.
nvideosetting	<positive integer>	3	0/7	Number of video settings per channel.
naudiosetting	<positive integer>	1	0/7	Number of audio settings per channel.

nuart	0, <positive integer>	1	0/7	Number of UART interfaces.
nvideoinprofile	<positive integer>	1	0/7	Number of video input profiles.
nmotionprofile	0, <positive integer>	1	0/7	Number of motion profiles.
ptzenabled	0, <positive integer>	189	0/7	<p>An 32-bit integer, each bit can be set separately as follows:</p> <p>Bit 0 =&gt; Support camera control function; 0(not support), 1(support)</p> <p>Bit 1 =&gt; Built-in or external camera; 0(external), 1(built-in)</p> <p>Bit 2 =&gt; Support pan operation, 0(not support), 1(support)</p> <p>Bit 3 =&gt; Support tilt operation; 0(not support), 1(support)</p> <p>Bit 4 =&gt; Support zoom operation; 0(not support), 1(support)</p> <p>Bit 5 =&gt; Support focus operation; 0(not support), 1(support)</p> <p>Bit 6 =&gt; Support iris operation; 0(not support), 1(support)</p> <p>Bit 7 =&gt; External or built-in PT; 0(built-in), 1(external)</p> <p>Bit 8 =&gt; Invalidate bit 1 ~ 7; 0(bit 1 ~ 7 are valid), 1(bit 1 ~ 7 are invalid)</p> <p>Bit 9 =&gt; Reserved bit; Invalidate lens_pan, Lens_tilt, lens_zoom,</p>

				lens_focus, len_iris. 0(fields are valid), 1(fields are invalid)
evctrlchannel	<boolean>	1	0/7	Indicate whether to support HTTP tunnel for event/control transfer.
joystick	<boolean>	1	0/7	Indicate whether to support joystick control.
storage_dbenabled	<boolean>	1	0/7	Media files are indexed in database.
ptzenabledclient	<boolean>	0	0/7	Indicate whether to support ptz client
protocol_https	< boolean >	1	0/7	Indicate whether to support HTTP over SSL.
protocol_rtsp	< boolean >	1	0/7	Indicate whether to support RTSP.
protocol_sip	<boolean>	1	0/7	Indicate whether to support SIP.
protocol_maxconnection	<positive integer>	10	0/7	The maximum allowed simultaneous connections.
protocol_maxgenconnection	<positive integer>	10	0/7	The maximum general streaming connections .
protocol_maxmegaconnection	<positive integer>	0	0/7	The maximum megapixel streaming connections.
protocol_rtp_multicast_scalable	<boolean>	1	0/7	Indicate whether to support scalable multicast.
protocol_rtp_multicast_backchannel	<boolean>	0	0/7	Indicate whether to support backchannel multicast.
protocol_rtp_tcp	<boolean>	1	0/7	Indicate whether to support RTP over TCP.
protocol_rtp_http	<boolean>	1	0/7	Indicate whether to support RTP over HTTP.
protocol_spush_mjpeg	<boolean>	1	0/7	Indicate whether to support server push MJPEG.
protocol_snmp	<boolean>	1	0/7	Indicate whether to support SNMP.
protocol_ipv6	<boolean>	1	0/7	Indicate whether to support IPv6.
videoin_type	0, 1, 2	2	0/7	0 => Interlaced CCD

				1 => Progressive CCD 2 => CMOS
videoin_resolution	<a list of available resolution separated by commas>	176x144, 320x240, 640x480, 1280x720, 1280x800	0/7	Available resolutions list.
videoin_maxframerate	<a list of available maximum frame rate separated by commas>	30, 30, 30, 30, 30	0/7	Available maximum frame list.
videoin_codec	mpeg4, mjpeg, h264	mpeg4, mjpeg, h264	0/7	Available codec list.
videoout_codec	<a list of the available codec types separated by commas>	<blank>	0/7	Available codec list.
audio_aec	<Boolean>	0	0/7	Indicate whether to support acoustic echo cancellation.
audio_extmic	<Boolean>	1	0/7	Indicate whether to support external microphone input.
audio_linein	<Boolean>	1	0/7	Indicate whether to support external line input. (It will be replaced by audio_mic and audio_extmic.)
audio_lineout	<Boolean>	1	0/7	Indicate whether to support line output.
audio_headphoneout	<Boolean>	0	0/7	Indicate whether to support headphone output.
audioin_codec	aac4, gamr, g711	aac4, gamr, g711	0/7	Available codec list for audio input.
audioout_codec	g711	<blank>	0/7	Available codec list for SIP.
camctrl_httpstunnel	<boolean>	0	0/7	Indicate whether to support httpstunnel.
camctrl_httpstunnelclient	<boolean>	0	0/7	Indicate whether to support

				httptunnel client.
camctrl_privilege	<boolean>	1	0/7	Indicate whether to support "Manage Privilege" of PTZ control in the Security page. 1: support both /cgi-bin/camctrl/camctrl.cgi and /cgi-bin/viewer/camctrl.cgi 0: support only /cgi-bin/viewer/camctrl.cgi
uart_httptunnel	<boolean>	0	0/7	Indicate whether to support HTTP tunnel for UART transfer.
transmission_mode	Tx, Rx, Both	Tx	0/7	Indicate transmission mode of the machine: TX = server, Rx = receiver box, Both = DVR.
network_wire	<boolean>	1	0/7	Indicate whether to support Ethernet.
network_wireless	<boolean>	0	0/7	Indicate whether to support wireless.
wireless_s802dot11b	<boolean>	0	0/7	Indicate whether to support wireless 802.11b+.
wireless_s802dot11g	<boolean>	0	0/7	Indicate whether to support wireless 802.11g.
wireless_encrypt_wep	<boolean>	0	0/7	Indicate whether to support wireless WEP.
wireless_encrypt_wpa	<boolean>	0	0/7	Indicate whether to support wireless WPA.
wireless_encrypt_wpa2	<boolean>	0	0/7	Indicate whether to support wireless WPA2.
wireless_beginchannel	1 ~ 14	1	0/7	Indicate the begin channel of wireless network
wireless_endchannel	1 ~ 14	14	0/7	Indicate the end channel of wireless network
derivative_brand	<boolean>	1	0/7	Indicate whether to support the upgrade function for the derivative brand. For example, if the value is

				true, the VVTK product can be upgraded to VVXX. (TCVV<->TCXX is excepted)
npreset	0, <positive integer>	20	0/7	Number of preset locations
eptz	0, <positive integer>	1	0/7	A 32-bit integer, each bit can be set separately as follows: Bit 0 => stream 1 supports ePTZ or not. Bit 1 => stream 2 supports ePTZ or not. The rest may be deduced by analogy
nanystream	0, <positive integer>	0	0/7	number of any media stream per channel
iva	<boolean>	0	0/7	Indicate whether to support Intelligent Video analysis
tampering	<boolean>	1	0/7	Indicate whether to support tampering detection.
test_ac	<boolean>	0	0/7	Indicate whether to support test ac key.
version_onvifdaemon	<string>	1.6.0.8	0/7	Indicate ONVIF daemon version
image_wdrc	<Boolean>	1	0/7	Indicate whether to support WDR enhanced.
image_iris_type	<string>	piris	0/7	Indicate iris type.
image_focusassist	<Boolean>	1	0/7	Indicate whether to support focus assist.

## 7.26 Customized event script

Group: event\_customtaskfile\_i<0~2>

PARAMETER	VALUE	Default	SECURITY (get/set)	DESCRIPTION
name	string[41]	<blank>	6/7	Custom script identification of this entry.
date	string[17]	<blank>	6/7	Date of custom script.
time	string[17]	<blank>	6/7	Time of custom script.

## 7.27 Event setting

Group: event\_i<0~2>

PARAMETER	VALUE	Default	SECURITY (get/set)	DESCRIPTION
name	string[40]	<blank>	6/6	Identification of this entry.
enable	0, 1	0	6/6	Enable or disable this event.
priority	0, 1, 2	1	6/6	Indicate the priority of this event: "0" = low priority "1" = normal priority "2" = high priority
delay	1~999	20	6/6	Delay in seconds before detecting the next event.
trigger	boot, di, motion, seq, recnotify, tampering, vi	boot	6/6	Indicate the trigger condition: "boot" = System boot "di" = Digital input "motion" = Video motion detection "seq" = Periodic condition "recnotify" = Recording notification. "tampering" = Tamper detection. "vi" = Virtual input (Manual trigger)
triggerstatus	String[40]	trigger	6/6	The status for event trigger
di	<integer>	1	6/6	Indicate the source id of di trigger. This field is required when trigger condition is "di". One bit represents one digital input. The LSB indicates DI 0.



mdwin	<integer>	0	6/6	<p>Indicate the source window id of motion detection.</p> <p>This field is required when trigger condition is "md".</p> <p>One bit represents one window.</p> <p>The LSB indicates the 1<sup>st</sup> window.</p> <p>For example, to detect the 1<sup>st</sup> and 3<sup>rd</sup> windows, set mdwin as 5.</p>
mdwin0	<integer>	0	6/6	<p>Similar to mdwin. The parameter takes effect when profile 1 of motion detection is enabled.</p>
vi	<integer>	0	6/6	<p>Indicate the source id of vi trigger.</p> <p>This field is required when trigger condition is "vi".</p> <p>One bit represents one digital input.</p> <p>The LSB indicates VI 0.</p>
inter	1~999	1	6/6	<p>Interval of snapshots in minutes.</p> <p>This field is used when trigger condition is "seq".</p>
weekday	0~127	127	6/6	<p>Indicate which weekday is scheduled.</p> <p>One bit represents one weekday.</p> <p>bit0 (LSB) = Saturday</p> <p>bit1 = Friday</p> <p>bit2 = Thursday</p> <p>bit3 = Wednesday</p> <p>bit4 = Tuesday</p> <p>bit5 = Monday</p> <p>bit6 = Sunday</p> <p>For example, to detect events on Friday and Sunday, set weekday as 66.</p>
begintime	hh:mm	00:00	6/6	<p>Begin time of the weekly schedule.</p>
endtime	hh:mm	24:00	6/6	<p>End time of the weekly schedule.</p> <p>(00:00 ~ 24:00 sets schedule as always on)</p>
lowlightcondition	0, 1	1	6/6	<p>Switch on white light LED in low light condition</p> <p>0 =&gt; Do action at all times</p> <p>1 =&gt; Do action in low-light conditions</p>

action_do_i<0~(ndo-1)>_enable	0, 1	0	6/6	Enable or disable trigger digital output.
action_do_i<0~(ndo-1)>_duration	1~999	1	6/6	Duration of the digital output trigger in seconds.
action_goto_enable	<Boolean>	0	6/6	Enable/disable ptz goto preset position on event triggered.
action_goto_name	string[40]	<blank>	6/6	Specify the preset name that ptz goto on event triggered.
action_cf_enable	<Boolean>	0	6/6	Enable or disable sending media to SD card.
action_cf_folder	string[128]	<blank>	6/6	Path to store media.
action_cf_media	NULL, 0~4	<blank>	6/6	Index of the attached media.
action_cf_datefolder	<boolean>	0	6/6	Enable this to create folders by date, time, and hour automatically.
action_cf_backup	<Boolean>	0	6/6	Enable or disable the function that send media to SD card for backup if network is disconnected.
action_server_i<0~4>_enable	0, 1	0	6/6	Enable or disable this server action.
action_server_i<0~4>_media	NULL, 0~4	<blank>	6/6	Index of the attached media.
action_server_i<0~4>_datefolder	<boolean>	0	6/6	Enable this to create folders by date, time, and hour automatically.
action_patrol_enable	<Boolean>	0	6/6	Enable/disable ptz patrol when event triggered.
action_patrol_server	0~255	0	6/6	Indicate the target servers to which the snapshots taken during patrol dwelling time should be sent. One bit represents one application server (server_i0~i4). bit0 (LSB) = server_i0. bit1 = server_i1. bit2 = server_i2. bit3 = server_i3. bit4 = server_i4. For example, enable server_i0, server_i2, and server_i4 as notification servers; the notifyserver value is 21.

## 7.28 Server setting for event action

Group: **server\_i**<0~4>

PARAMETER	VALUE	DEFAULT	SECURITY (get/set)	DESCRIPTION
Name	string[40]	NULL	6/6	Identification of this entry
Type	email, ftp, http, ns	email	6/6	Indicate the server type: "email" = email server "ftp" = FTP server "http" = HTTP server "ns" = network storage
http_url	string[128]	http://	6/6	URL of the HTTP server to upload.
http_username	string[64]	NULL	6/6	Username to log in to the server.
http_passwd	string[64]	NULL	6/6	Password of the user.
ftp_address	string[128]	NULL	6/6	FTP server address.
ftp_username	string[64]	NULL	6/6	Username to log in to the server.
ftp_passwd	string[64]	NULL	6/6	Password of the user.
ftp_port	0~65535	21	6/6	Port to connect to the server.
ftp_location	string[128]	NULL	6/6	Location to upload or store the media.
ftp_passive	0, 1	1	6/6	Enable or disable passive mode. 0 = disable passive mode 1 = enable passive mode
email_address	string[128]	NULL	6/6	Email server address.
email_sslmode	0, 1	0	6/6	Enable support SSL.
email_port	0~65535	25	6/6	Port to connect to the server.
email_username	string[64]	NULL	6/6	Username to log in to the server.
email_passwd	string[64]	NULL	6/6	Password of the user.
email_senderemail	string[128]	NULL	6/6	Email address of the sender.
email_recipientemail	string[128]	NULL	6/6	Email address of the recipient.
ns_location	string[128]	NULL	6/6	Location to upload or store the media.
ns_username	string[64]	NULL	6/6	Username to log in to the server.
ns_passwd	string[64]	NULL	6/6	Password of the user.
ns_workgroup	string[64]	NULL	6/6	Workgroup for network storage.

## 7.29 Media setting for event action

Group: **media\_i<0~4>** (media\_freespace is used internally.)

PARAMETER	VALUE	DEFAULT	SECURITY (get/set)	DESCRIPTION
name	string[40]	NULL	6/6	Identification of this entry
type	snapshot, systemlog, videoclip, recordmsg	snapshot	6/6	Media type to send to the server or store on the server.
snapshot_source	0 ~ 1	0	6/6	Indicate the source of media stream. 0 means the first stream. 1 means the second stream and etc.
snapshot_prefix	string[16]	<blank>	6/6	Indicate the prefix of the filename.
snapshot_datesuffix	0, 1	0	6/6	Add date and time suffix to filename: 1 = Add date and time suffix. 0 = Do not add.
snapshot_preevent	0 ~ 7	1	6/6	Indicates the number of pre-event images.
snapshot_postevent	0 ~ 7	1	6/6	The number of post-event images.
videoclip_source	0 ~ 1	0	6/6	Indicate the source of media stream. 0 means the first stream. 1 means the second stream and etc.
videoclip_prefix	string[16]	<blank>	6/6	Indicate the prefix of the filename.
videoclip_preevent	0~9	0	6/6	Indicates the time for pre-event recording in seconds.
videoclip_maxduration	1 ~ 20	5	6/6	Maximum duration of one video clip in seconds.
videoclip_maxsize	50 ~ 5120	1000	6/6	Maximum size of one video clip file in Kbytes.

## 7.30 Recording

Group: **recording\_i**<0~1>

PARAMETER	VALUE	DEFAULT	SECURITY (get/set)	DESCRIPTION
name	string[40]	NULL	6/6	Identification of this entry.
trigger	schedule, networkfail	schedule	6/6	The event trigger type schedule: The event is triggered by schedule networkfail: The event is triggered by the failure of network connection.
enable	0, 1	0	6/6	Enable or disable this recording.
priority	0, 1, 2	1	6/6	Indicate the priority of this recording: "0" indicates low priority. "1" indicates normal priority. "2" indicates high priority.
source	0~1	0	6/6	Indicate the source of media stream. 0 means the first stream. 1 means the second stream and so on.
limitsize	0,1	0	6/6	0: Entire free space mechanism 1: Limit recording size mechanism
cyclic	0,1	0	6/6	0: Disable cyclic recording 1: Enable cyclic recording
notify	0,1	1	6/6	0: Disable recording notification 1: Enable recording notification

notifyserver	0~31	0	6/6	<p>Indicate which notification server is scheduled.</p> <p>One bit represents one application server (server_i0~i4).</p> <p>bit0 (LSB) = server_i0.</p> <p>bit1 = server_i1.</p> <p>bit2 = server_i2.</p> <p>bit3 = server_i3.</p> <p>bit4 = server_i4.</p> <p>For example, enable server_i0, server_i2, and server_i4 as notification servers; the notifyserver value is 21.</p>
weekday	0~127	127	6/6	<p>Indicate which weekday is scheduled.</p> <p>One bit represents one weekday.</p> <p>bit0 (LSB) = Saturday</p> <p>bit1 = Friday</p> <p>bit2 = Thursday</p> <p>bit3 = Wednesday</p> <p>bit4 = Tuesday</p> <p>bit5 = Monday</p> <p>bit6 = Sunday</p> <p>For example, to detect events on Friday and Sunday, set weekday as 66.</p>
begintime	hh:mm	00:00	6/6	Start time of the weekly schedule.
endtime	hh:mm	24:00	6/6	End time of the weekly schedule. (00:00~24:00 indicates schedule always on)
prefix	string[16]	<blank>	6/6	Indicate the prefix of the filename.
cyclesize	200~	100	6/6	The maximum size for cycle recording in Kbytes when choosing to limit recording size. (not used in IP8162)
reserveamount	0~	100	6/6	The reserved amount in Mbytes when choosing cyclic recording mechanism.

dest	cf, 0~4	cf	6/6	The destination to store the recorded data. "cf" means local storage (CF or SD card). "0" means the index of the network storage.
cffolder	string[128]	NULL	6/6	Folder name.
adaptive_enable	0,1	0	6/6	Indicate whether the adaptive recording is enabled
adaptive_preevent	0~9	1	6/6	Indicate when is the adaptive recording started before the event trigger point (seconds)
adaptive_postevent	0~10	1	6/6	Indicate when is the adaptive recording stopped after the event trigger point (seconds)

## 7.31 HTTPS

Group: **https** (capability.protocol.https > 0)

NAME	VALUE	DEFAULT	SECURITY (get/set)	DESCRIPTION
enable	<boolean>	0	6/6	To enable or disable secure HTTP.
policy	<Boolean>	0	6/6	If the value is 1, it will force HTTP connection redirect to HTTPS connection
method	auto, manual, install	auto	6/6	auto => Create self-signed certificate automatically. manual => Create self-signed certificate manually. install => Create certificate request and install.
status	-3 ~ 1	0	6/7	Specify the https status. -3 = Certificate not installed -2 = Invalid public key -1 = Waiting for certificate 0 = Not installed 1 = Active
countryname	string[2]	TW	6/6	Country name in the certificate

				information.
stateorprovincename	string[128]	Asia	6/6	State or province name in the certificate information.
localityname	string[128]	Asia	6/6	The locality name in the certificate information.
organizationname	string[64]	Vivotek.Inc	6/6	Organization name in the certificate information.
unit	string[32]	Vivotek.Inc	6/6	Organizational unit name in the certificate information.
commonname	string[64]	www.vivotek.com	6/6	Common name in the certificate information.
validdays	0 ~ 3650	3650	6/6	Valid period for the certification.

## 7.32 Storage management setting

Currently it's for local storage (SD, CF card)

Group: **disk\_i<0~(n-1)>** n is the total number of storage devices. (**capability.storage.dbenabled > 0**)

PARAMETER	VALUE	Default	SECURITY (get/set)	DESCRIPTION
cyclic_enabled	<boolean>	0	6/6	Enable cyclic storage method.
autocleanup_enabled	<boolean>	0	6/6	Enable automatic clean up method. Expired and not locked media files will be deleted.
autocleanup_maxage	<positive integer>	7	6/6	To specify the expired days for automatic clean up.

## 7.33 Region of interest

Group: **roi\_c<0~(n-1)>** for n channel product, and m is the number of streams which support ROI.

(**capability.eptz > 0**)

PARAMETER	VALUE	Default	SECURITY (get/set)	DESCRIPTION
s<0~(m-1)>_home	<coordinate>	0,0	6/6	ROI left-top corner coordinate.
s<0~(m-1)>_size	<window size>	1280x800	6/6	ROI width and height. The width value must be multiples of 16 and the height value must be multiples of 8



## 7.34 ePTZ setting

Group: **eptz\_c<0~(n-1)>** for n channel product. (**capability.eptz > 0**)

PARAMETER	VALUE	Default	SECURITY (get/set)	DESCRIPTION
osdzoom	<boolean>	1	1/4	Indicates multiple of zoom in is "on-screen display" or not
smooth	<boolean>	1	1/4	Enable the ePTZ "move smoothly" feature
tiltspeed	-5 ~ 5	0	1/7	Tilt speed (It should be set by eCamCtrl.cgi rather than by setparam.cgi.)
panspeed	-5 ~ 5	0	1/7	Pan speed (It should be set by eCamCtrl.cgi rather than by setparam.cgi.)
zoomspeed	-5 ~ 5	0	1/7	Zoom speed (It should be set by eCamCtrl.cgi rather than by setparam.cgi.)
autospeed	1 ~ 5	1	1/7	Auto pan/patrol speed (It should be set by eCamCtrl.cgi rather than by setparam.cgi.)

Group: **eptz\_c<0~(n-1)>\_s<0~(m-1)>** for n channel product and m is the number of streams which support ePTZ. (**capability.eptz > 0**)

PARAMETER	VALUE	Default	SECURITY (get/set)	DESCRIPTION
patrolseq	string[120]	<blank>	1/4	The patrol sequence of ePTZ. All the patrol position indexes will be separated by ","
patroldwelling	string[160]	<blank>	1/4	The dwelling time (unit: second) of each patrol point, separated by ",".
preset_i<0~19>_name	string[40]	<blank>	1/7	Name of ePTZ preset. (It should be set by ePreset.cgi rather than by setparam.cgi.)
preset_i<0~19>_pos	<coordinate>	<blank>	1/7	Left-top corner coordinate of the preset. (It should be set by ePreset.cgi rather than by setparam.cgi.)

preset_i<0~19>_size	<window size>	<blank>	1/7	Width and height of the preset. (It should be set by ePreset.cgi rather than by setparam.cgi.)
---------------------	---------------	---------	-----	---

## 8. Useful Functions

### 8.1 Drive the Digital Output (**capability.ndo > 0**)

**Note:** This request requires Viewer privileges.

**Method:** GET/POST

Syntax:

```
http://<servername>/cgi-bin/dido/setdo.cgi?do1=<state>[&do2=<state>]
[&do3=<state>][&do4=<state>]
```

Where state is 0 or 1; "0" means inactive or normal state, while "1" means active or triggered state.

PARAMETER	VALUE	DESCRIPTION
do<num>	0, 1	0 - Inactive, normal state
		1 - Active, triggered state

**Example:** Drive the digital output 1 to triggered state and redirect to an empty page.

<http://myserver/cgi-bin/dido/setdo.cgi?do1=1>

### 8.2 Query Status of the Digital Input (**capability.ndi > 0**)

**Note:** This request requires Viewer privileges

**Method:** GET/POST

Syntax:

```
http://<servername>/cgi-bin/dido/getdi.cgi?[di0][&di1][&di2][&di3]
```

If no parameter is specified, all of the digital input statuses will be returned.

Return:

```
HTTP/1.0 200 OK\r\n
Content-Type: text/plain\r\n
Content-Length: <length>\r\n
\r\n
[di0=<state>]\r\n
[di1=<state>]\r\n
[di2=<state>]\r\n
[di3=<state>]\r\n
```

where <state> can be 0 or 1.

**Example:** Query the status of digital input 1 .

Request:

<http://myserver/cgi-bin/dido/getdi.cgi?di1>

Response:

HTTP/1.0 200 OK\r\n

Content-Type: text/plain\r\n

Content-Length: 7\r\n

\r\n

di1=1\r\n

## 8.3 Query Status of the Digital Output (**capability.ndo > 0**)

**Note:** This request requires Viewer privileges

**Method:** GET/POST

Syntax:

```
http://<servername>/cgi-bin/dido/getdo.cgi?[do0][&do1][&do2][&do3]
```

If no parameter is specified, all the digital output statuses will be returned.

Return:

```
HTTP/1.0 200 OK\r\n
```

```
Content-Type: text/plain\r\n
```

```
Content-Length: <length>\r\n
```

```
\r\n
```

```
[do0=<state>]\r\n
```

```
[do1=<state>]\r\n
```

```
[do2=<state>]\r\n
```

```
[do3=<state>]\r\n
```

where <state> can be 0 or 1.

**Example:** Query the status of digital output 1.

Request:

<http://myserver/cgi-bin/dido/getdo.cgi?do1>

Response:

HTTP/1.0 200 OK\r\n

Content-Type: text/plain\r\n

Content-Length: 7\r\n

```
\r\n
do1=1\r\n
```

## 8.4 3D Privacy Mask

**Note:** This request requires admin user privilege

<SD81X1> You can set privacy mask only at zoom 1x. To go back to zoom 1x directly, please send this cgi command: "/cgi-bin/camctrl/camposition.cgi?setzoom=0"

**Method:** GET/POST

Syntax:

http://<servername>/cgi-bin/admin/setpm3d.cgi?method=<value>&name=<value>&[maskheight=<value>&maskwidth=<value>&return=<return page>]

PARAMETER	VALUE	DESCRIPTION
method	add	Add a 3D privacy mask at current location
	delete	Delete a 3D privacy mask
	edit	Edit a 3D privacy mask
maskname	string[40]	3D privacy mask name
maskheight	integer	3D privacy mask height
maskwidth	integer	3D privacy mask width
return	<return page>	Redirect to page <return page> after the 3D privacy mask is configured. The <return page> can be a full URL path or relative path according to the current path. If you omit this parameter, it will redirect to an empty page.

## 8.5 Capture Single Snapshot

**Note:** This request requires Normal User privileges.

**Method:** GET/POST

Syntax:

```
http://<servername>/cgi-bin/viewer/video.jpg?[channel=<value>][&resolution=<value>]
[&quality=<value>][&streamid=<value>]
```

If the user requests a size larger than all stream settings on the server, this request will fail.

PARAMETER	VALUE	DEFAULT	DESCRIPTION
channel	0~(n-1)	0	The channel number of the video source.
resolution	<available>	0	The resolution of the image.

	resolution>		
quality	1~5	3	The quality of the image.
streamid	0~(m-1)	<product dependent>	The stream number.

The server will return the most up-to-date snapshot of the selected channel and stream in JPEG format. The size and quality of the image will be set according to the video settings on the server.

Return:

```
HTTP/1.0 200 OK\r\n
Content-Type: image/jpeg\r\n
[Content-Length: <image size>\r\n]

<binary JPEG image data>
```

## 8.6 Account Management

**Note:** This request requires Administrator privileges.

**Method:** GET/POST

Syntax:

```
http://<servername>/cgi-bin/admin/editaccount.cgi?
method=<value>&username=<name>[&userpass=<value>][&privilege=<value>]
[&privilege=<value>][...][&return=<return page>]
```

PARAMETER	VALUE	DESCRIPTION
method	Add	Add an account to the server. When using this method, the "username" field is necessary. It will use the default value of other fields if not specified.
	Delete	Remove an account from the server. When using this method, the "username" field is necessary, and others are ignored.
	edit	Modify the account password and privilege. When using this method, the "username" field is necessary, and other fields are optional. If not specified, it will keep the original settings.
username	<name>	The name of the user to add, delete, or edit.
userpass	<value>	The password of the new user to add or that of the old user to modify. The default value is an empty string.
Privilege	<value>	The privilege of the user to add or to modify.
	viewer	Viewer privilege.

	operator	Operator privilege.
	admin	Administrator privilege.
Return	<return page>	Redirect to the page <return page> after the parameter is assigned. The <return page> can be a full URL path or relative path according to the current path. If you omit this parameter, it will redirect to an empty page.

## 8.7 System Logs

**Note:** This request require Administrator privileges.

**Method:** GET/POST

Syntax:

```
http://<servername>/cgi-bin/admin/syslog.cgi
```

Server will return the most up-to-date system log.

Return:

```
HTTP/1.0 200 OK\r\n
Content-Type: text/plain\r\n
Content-Length: <syslog length>\r\n
\r\n
<system log information>\r\n
```

## 8.8 Upgrade Firmware

**Note:** This request requires Administrator privileges.

Method: POST

Syntax:

```
http://<servername>/cgi-bin/admin/upgrade.cgi
```

Post data:

```
fimage=<file name>[&return=<return page>]\r\n
\r\n
<multipart encoded form data>
```

Server will accept the file named <file name> to upgrade the firmware and return with <return page> if indicated.

## 8.9 Camera Control (capability.ptzenabled)

**Note:** This request requires Viewer privileges.

**Method:** GET/POST

Syntax:

```

http://<servername>/cgi-bin/viewer/camctrl.cgi?[channel=<value>][&camid=<value>]
[&move=<value>] - Move home, up, down, left, right
[&focus=<value>] - Focus operation
[&iris=<value>] - Iris operation
[&auto=<value>] - Auto pan, patrol
[&zoom=<value>] - Zoom in, out
[&zooming=<value>&zs=<value>] - Zoom without stopping, used for joystick
[&vx=<value>&vy=<value>&vs=<value>] - Shift without stopping, used for joystick
[&x=<value>&y=<value>&videosize=<value>&resolution=<value>&stretch=<value>] - Click on image
(Move the center of image to the coordination (x,y) based on resolution or videoseize.)
[ [&speedpan=<value>][&speedtilt=<value>][&speedzoom=<value>][&speedapp=<value>][&speedlink
=<value>] ] - Set speeds
[&return=<return page>]

```

Example:

```

http://myserver/cgi-bin/viewer/camctrl.cgi?channel=0&camid=1&move=right
http://myserver/cgi-bin/viewer/camctrl.cgi?channel=0&camid=1&zoom=tele
http://myserver/cgi-bin/viewer/camctrl.cgi?channel=0&camid=1&x=300&y=200&resolution=704x480&videoseize=704x480&stretch=1

```

PARAMETER	VALUE	DESCRIPTION
channel	<0~(n-1)>	Channel of video source.
camid	0,<positive integer>	Camera ID.
move	home	Move to camera to home position.
	up	Move camera up.
	down	Move camera down.
	left	Move camera left.
	right	Move camera right.
speedpan	-5 ~ 5	Set the pan speed.
speedtilt	-5 ~ 5	Set the tilt speed.
speedzoom	-5 ~ 5	Set the zoom speed.



speedfocus	-5 ~ 5	Set the focus speed.
speedapp	-5 ~ 5	Set the auto pan/patrol speed.
auto	pan	Auto pan.
	patrol	Auto patrol.
	stop	Stop camera.
zoom	wide	Zoom larger view with current speed.
	tele	Zoom further with current speed.
	stop	Stop zoom.
zooming	wide or tele	Zoom without stopping for larger view or further view with zs speed, used for joystick control.
zs	0 ~ 6	Set the speed of zooming, "0" means stop.
	0 ~ 15 <SD81X1>	
vx	<integer , excluding 0>	The slope of movement = $v_y/v_x$ , used for joystick control.
vy	<integer>	
vs	0 ~ 7	Set the speed of movement, "0" means stop.
	0 ~ 15 <SD81X1>	
x	<integer>	x-coordinate clicked by user. It will be the x-coordinate of center after movement.
y	<integer>	y-coordinate clicked by user. It will be the y-coordinate of center after movement.
videosize	<window size>	The size of plug-in (ActiveX) window in web page
resolution	<window size>	The resolution of streaming.
stretch	<boolean>	0 indicates that it uses <b>resolution</b> (streaming size) as the range of the coordinate system. 1 indicates that it uses <b>videosize</b> (plug-in size) as the range of the coordinate system.
focus	auto	Auto focus.
	far	Focus on further distance.
	near	Focus on closer distance.
iris	auto	Let the Network Camera control iris size.
	open	Manually control the iris for bigger size.
	close	Manually control the iris for smaller size.
speedlink	0 ~ 4	Issue speed link command.

gaptime	0~32768	The gaptime between two consecutive ptz commands for device. (unit: ms)
return	<return page>	Redirect to the page <return page> after the parameter is assigned. The <return page> can be a full URL path or relative path according to the current path. If you omit this parameter, it will redirect to an empty page.

## 8.10 ePTZ Camera Control (**capability.eptz > 0**)

**Note:** This request requires camctrl privileges.

**Method:** GET/POST

Syntax:

```
http://<servername>/cgi-bin/camctrl/eCamCtrl.cgi?channel=<value>&stream=<value>
[&move=<value>] - Move home, up, down, left, right
[&auto=<value>] - Auto pan, patrol
[&zoom=<value>] - Zoom in, out
[&zooming=<value>&zs=<value>] - Zoom without stopping, used for joystick
[&vx=<value>&vy=<value>&vs=<value>] - Shift without stopping, used for joystick
[&x=<value>&y=<value>&videosize=<value>&resolution=<value>&stretch=<value>] - Click on image
(Move the center of image to the coordination (x,y) based on resolution or videosize.)
[ [&speedpan=<value>][&speedtilt=<value>][&speedzoom=<value>][&speedapp=<value>] ] - Set
speeds
[&return=<return page>]
```

Example:

```
http://myserver/cgi-bin/camctrl/eCamCtrl.cgi?channel=0&stream=0&move=right
http://myserver/cgi-bin/camctrl/eCamCtrl.cgi?channel=0&stream=1&vx=2&vy=2&vz=2
http://myserver/cgi-bin/camctrl/eCamCtrl.cgi?channel=0&stream=1&x=100&y=100&videosize=640x480&resolution=640x480&stretch=0
```

PARAMETER	VALUE	DESCRIPTION
channel	<0~(n-1)>	Channel of video source.
stream	<0~(m-1)>	Stream.
move	home	Move to home ROI.
	up	Move up.
	down	Move down.
	left	Move left.
	right	Move right.

auto	pan	Auto pan.
	patrol	Auto patrol.
	stop	Stop auto pan/patrol.
zoom	wide	Zoom larger view with current speed.
	tele	Zoom further with current speed.
zooming	wide or tele	Zoom without stopping for larger view or further view with zs speed, used for joystick control.
zs	0 ~ 6	Set the speed of zooming, "0" means stop.
vx	<integer>	The direction of movement, used for joystick control.
vy	<integer>	
vs	0 ~ 7	Set the speed of movement, "0" means stop.
x	<integer>	x-coordinate clicked by user. It will be the x-coordinate of center after movement.
y	<integer>	y-coordinate clicked by user. It will be the y-coordinate of center after movement.
videosize	<window size>	The size of plug-in (ActiveX) window in web page
resolution	<window size>	The resolution of streaming.
stretch	<boolean>	0 indicates that it uses <b>resolution</b> (streaming size) as the range of the coordinate system. 1 indicates that it uses <b>videosize</b> (plug-in size) as the range of the coordinate system.
speedpan	-5 ~ 5	Set the pan speed.
speedtilt	-5 ~ 5	Set the tilt speed.
speedzoom	-5 ~ 5	Set the zoom speed.
speedapp	1 ~ 5	Set the auto pan/patrol speed.
return	<return page>	Redirect to the page <return page> after the parameter is assigned. The <return page> can be a full URL path or relative path according to the current path.

## 8.11 Recall (capability.ptzenabled)

**Note:** This request requires Viewer privileges.

Method: GET

Syntax:

```
http://<servername>/cgi-bin/viewer/recall.cgi?
recall=<value>[&channel=<value>][&return=<return page>]
```

PARAMETER	VALUE	DESCRIPTION
recall	Text string less than 30 characters	One of the present positions to recall.
channel	<0~(n-1)>	Channel of the video source.
return	<return page>	Redirect to the page <return page> after the parameter is assigned. The <return page> can be a full URL path or relative path according to the current path. If you omit this parameter, it will redirect to an empty page.

## 8.12 ePTZ Recall (capability.eptz > 0)

**Note:** This request requires camctrl privileges.

Method: GET/POST

Syntax:

```
http://<servername>/cgi-bin/camctrl/eRecall.cgi?channel=<value>&stream=<value>&
recall=<value>[&return=<return page>]
```

PARAMETER	VALUE	DESCRIPTION
channel	<0~(n-1)>	Channel of the video source.
stream	<0~(m-1)>	Stream.
recall	Text string less than 40 characters	One of the present positions to recall.
return	<return page>	Redirect to the page <return page> after the parameter is assigned. The <return page> can be a full URL path or relative path according to the current path.

## 8.13 Preset Locations (capability.ptzenabled)

**Note:** This request requires Operator privileges.

**Method:** GET/POST

Syntax:

```
http://<servername>/cgi-bin/operator/preset.cgi?[channel=<value>]
[&addpos=<value>][&delpos=<value>][&return=<return page>]
```

PARAMETER	VALUE	DESCRIPTION
addpos	<Text string less than 30 characters>	Add one preset location to the preset list.
channel	<0~(n-1)>	Channel of the video source.
delpos	<Text string less than 30 characters>	Delete preset location from preset list.
return	<return page>	Redirect to the page <return page> after the parameter is assigned. The <return page> can be a full URL path or relative path according to the current path. If you omit this parameter, it will redirect to an empty page.

## 8.14 ePTZ Preset Locations (capability.eptz > 0)

**Note:** This request requires Operator privileges.

**Method:** GET/POST

Syntax:

```
http://<servername>/cgi-bin/operator/ePreset.cgi?channel=<value>&stream=<value>
[&addpos=<value>][&delpos=<value>][&return=<return page>]
```

PARAMETER	VALUE	DESCRIPTION
channel	<0~(n-1)>	Channel of the video source.
stream	<0~(m-1)>	Stream.
addpos	<Text string less than 40 characters>	Add one preset location to the preset list.

delpos	<Text string less than 40 characters>	Delete preset location from the preset list.
return	<return page>	Redirect to the page <return page> after the parameter is assigned. The <return page> can be a full URL path or relative path according to the current path.

## 8.15 IP Filtering

**Note:** This request requires Administrator access privileges.

**Method:** GET/POST

Syntax: <product dependent>

<pre>http://&lt;servername&gt;/cgi-bin/admin/ipfilter.cgi?type[=&lt;value&gt;] http://&lt;servername&gt;/cgi-bin/admin/ipfilter.cgi?method=add&lt;v4/v6&gt;&amp;ip=&lt;ipaddress&gt;[&amp;index=&lt;value&gt;] [&amp;return=&lt;return page&gt;] http://&lt;servername&gt;/cgi-bin/admin/ipfilter.cgi?method=del&lt;v4/v6&gt;&amp;index=&lt;value&gt;[&amp;return=&lt;return page&gt;]</pre>		
PARAMETER	VALUE	DESCRIPTION
type	NULL	Get IP filter type
	allow, deny	Set IP filter type
method	addv4	Add IPv4 address into access list.
	addv6	Add IPv6 address into access list.
	delv4	Delete IPv4 address from access list.
	delv6	Delete IPv6 address from access list.
ip	<IP address>	Single address: <IP address> Network address: <IP address / network mask> Range address: <start IP address - end IP address>
index	<value>	The start position to add or to delete.
return	<return page>	Redirect to the page <return page> after the parameter is assigned. The <return page> can be a full URL path or relative path according to the current path. If you omit this parameter, it will redirect to an empty page.

## 8.16 UART HTTP Tunnel Channel (**capability.nuart > 0**)

**Note:** This request requires Operator privileges.

**Method:** GET and POST

Syntax:

```
http://<servername>/cgi-bin/operator/uartchannel.cgi?[channel=<value>]
```

```
-----
```

```
GET /cgi-bin/operator/uartchannel.cgi?[channel=<value>]
```

```
x-sessioncookie: string[22]
```

```
accept: application/x-vvtk-tunnelled
```

```
pragma: no-cache
```

```
cache-control: no-cache
```

```
-----
```

```
POST /cgi-bin/operator/uartchannel.cgi
```

```
x-sessioncookie: string[22]
```

```
content-type: application/x-vvtk-tunnelled
```

```
pragma : no-cache
```

```
cache-control : no-cache
```

```
content-length: 32767
```

```
expires: Sun, 9 Jan 1972 00:00:00 GMT
```

User must use GET and POST to establish two channels for downstream and upstream. The x-sessioncookie in GET and POST should be the same to be recognized as a pair for one session. The contents of upstream should be base64 encoded to be able to pass through a proxy server.

This channel will help to transfer the raw data of UART over the network.

Please see UART tunnel spec for detail information

PARAMETER	VALUE	DESCRIPTION
channel	0 ~ (n-1)	The channel number of UART.

## 8.17 Event/Control HTTP Tunnel Channel (**capability.**

### **evctrlchannel > 0)**

**Note:** This request requires **Administrator** privileges.

**Method:** GET and POST

Syntax:

```
http://<servername>/cgi-bin/admin/ctrlevent.cgi
```

```
-----
```

```
GET /cgi-bin/admin/ctrlevent.cgi
```

```
x-sessioncookie: string[22]
```

```
accept: application/x-vvtk-tunnelled
```

```
pragma: no-cache
```

```
cache-control: no-cache
```

```
-----
```

```
POST /cgi-bin/admin/ ctrlevent.cgi
```

```
x-sessioncookie: string[22]
```

```
content-type: application/x-vvtk-tunnelled
```

```
pragma : no-cache
```

```
cache-control : no-cache
```

```
content-length: 32767
```

```
expires: Sun, 9 Jan 1972 00:00:00 GMT
```

User must use GET and POST to establish two channels for downstream and upstream. The x-sessioncookie in GET and POST should be the same to be recognized as a pair for one session. The contents of upstream should be base64 encoded to be able to pass through the proxy server.

This channel will help perform real-time event subscription and notification as well as camera control more efficiently. The event and control formats are described in another document.

See Event/control tunnel spec for detail information



## 8.18 Get SDP of Streams

**Note:** This request requires Viewer access privileges.

**Method:** GET/POST

Syntax:

```
http://<servername>/<network_rtsp_s<0~m-1>_accessname>
```

"m" is the stream number.

"network\_accessname\_<0~(m-1)>" is the accessname for stream "1" to stream "m". Please refer to the "subgroup of network: rtsp" for setting the accessname of SDP.

You can get the SDP by HTTP GET.

When using scalable multicast, Get SDP file which contains the multicast information via HTTP.

## 8.19 Open the Network Stream

**Note:** This request requires Viewer access privileges.

Syntax:

For HTTP push server (MJPEG):

```
http://<servername>/<network_http_s<0~m-1>_accessname>
```

For RTSP (MP4), the user needs to input the URL below into an RTSP compatible player.

```
rtsp://<servername>/<network_rtsp_s<0~m-1>_accessname>
```

"m" is the stream number.

For details on streaming protocol, please refer to the "control signaling" and "data format" documents.

## 8.20 Senddata (capability.nuart > 0)

**Note:** This request requires Viewer privileges.

Method: GET/POST

Syntax:

```
http://<servername>/cgi-bin/viewer/senddata.cgi?
[com=<value>][&data=<value>][&flush=<value>] [&wait=<value>] [&read=<value>]
```

PARAMETER	VALUE	DESCRIPTION
com	1 ~ <max. com port number>	The target COM/RS485 port number.
data	<hex decimal data>[,<hex decimal data>]	The <hex decimal data> is a series of digits from 0 ~ 9, A ~ F. Each comma separates the commands by 200 milliseconds.
flush	yes,no	yes: Receive data buffer of the COM port will be cleared before read. no: Do not clear the receive data buffer.
wait	1 ~ 65535	Wait time in milliseconds before read data.
read	1 ~ 128	The data length in bytes to read. The read data will be in the return page.

Return:

```
HTTP/1.0 200 OK\r\n
Content-Type: text/plain\r\n
Content-Length: <system information length>\r\n
\r\n
<hex decimal data>\r\n
```

Where hexadecimal data is digits from 0 ~ 9, A ~ F.

## 8.21 Storage managements (capability.storage.dbenabled > 0)

**Note:** This request requires **administrator** privileges.

**Method:** GET and POST

Syntax:

```
http://<servername>/cgi-bin/admin/lctrl.cgi?cmd=<cmd_type>[&<parameter>=<value>...]
```

The commands usage and their input arguments are as follows.

PARAMETER	VALUE	DESCRIPTION
cmd_type	<string>	Required. Command to be executed, including <i>search</i> , <i>insert</i> , <i>delete</i> , <i>update</i> , and <i>queryStatus</i> .

Command: **search**

PARAMETER	VALUE	DESCRIPTION
label	<integer primary key>	Optional. The integer primary key column will automatically be assigned a unique integer.
triggerType	<text>	Optional. Indicate the event trigger type. Please embrace your input value with single quotes. Ex. mediaType='motion' Support trigger types are product dependent.
mediaType	<text>	Optional. Indicate the file media type. Please embrace your input value with single quotes. Ex. mediaType='videoclip' Support trigger types are product dependent.
destPath	<text>	Optional. Indicate the file location in camera. Please embrace your input value with single quotes. Ex. destPath = '/mnt/auto/CF/NCMF/abc.mp4'
resolution	<text>	Optional. Indicate the media file resolution. Please embrace your input value with single quotes. Ex. resolution='800x600'
isLocked	<boolean>	Optional.

		<p>Indicate if the file is locked or not.</p> <p>0: file is not locked.</p> <p>1: file is locked.</p> <p>A locked file would not be removed from UI or cyclic storage.</p>
triggerTime	<text>	<p>Optional.</p> <p>Indicate the event trigger time. (not the file created time)</p> <p>Format is "YYYY-MM-DD HH:MM:SS"</p> <p>Please embrace your input value with single quotes.</p> <p>Ex. triggerTime='2008-01-01 00:00:00'</p> <p>If you want to search for a time period, please apply "TO" operation.</p> <p>Ex. triggerTime='2008-01-01 00:00:00'+TO+'2008-01-01 23:59:59' is to search for records from the start of Jan 1<sup>st</sup> 2008 to the end of Jan 1<sup>st</sup> 2008.</p>
limit	<positive integer>	<p>Optional.</p> <p>Limit the maximum number of returned search records.</p>
offset	<positive integer>	<p>Optional.</p> <p>Specifies how many rows to skip at the beginning of the matched records.</p> <p>Note that the offset keyword is used after limit keyword.</p>

To increase the flexibility of search command, you may use "OR" connectors for logical "OR" search operations. Moreover, to search for a specific time period, you can use "TO" connector.

Ex. To search records triggered by motion or di or sequential and also triggered between 2008-01-01 00:00:00 and 2008-01-01 23:59:59.

```
http://<servername>/cgi-bin/admin/lctrl.cgi?cmd=search&triggerType='motion'+OR+'di'+OR+'seq'&triggerTime='2008-01-01 00:00:00'+TO+'2008-01-01 23:59:59'
```

Command: **delete**

PARAMETER	VALUE	DESCRIPTION
label	<integer primary key>	<p>Required.</p> <p>Identify the designated record.</p> <p>Ex. label=1</p>

Ex. Delete records whose key numbers are 1, 4, and 8.

```
http://<servername>/cgi-bin/admin/lctrl.cgi?cmd=delete&label=1&label=4&label=8
```

Command: **update**

PARAMETER	VALUE	DESCRIPTION
-----------	-------	-------------

label	<integer primary key>	Required. Identify the designated record. Ex. label=1
isLocked	<boolean>	Required. Indicate if the file is locked or not.

Ex. Update records whose key numbers are 1 and 5 to be locked status.

```
http://<servername>/cgi-bin/admin/lctrl.cgi?cmd=update&isLocked=1&label=1&label=5
```

Ex. Update records whose key numbers are 2 and 3 to be unlocked status.

```
http://<servername>/cgi-bin/admin/lctrl.cgi?cmd=update&isLocked=0&label=2&label=3
```

Command: queryStatus

PARAMETER	VALUE	DESCRIPTION
retType	xml or javascript	Optional. Ex. retype=javascript The default return message is in XML format.

Ex. Query local storage status and call for javascript format return message.

```
http://<servername>/cgi-bin/admin/lctrl.cgi?cmd=queryStatus&retType=javascript
```

## 8.22 Virtual input (**capability.nvi > 0**)

**Note:** Change virtual input (manual trigger) status.

Method: GET

Syntax:

```
http://<servername>/cgi-bin/admin/setvi.cgi?vi0=<value>[&vi1=<value>][&vi2=<value>]  
[&return=<return page>]
```

PARAMETER	VALUE	DESCRIPTION
vi<num>	state[(duration)nstate]  Where "state" is 0, 1. "0" means inactive or normal state while "1" means active or triggered state. Where "nstate" is next	Ex: vi0=1 Setting virtual input 0 to trigger state  Ex: vi0=0(200)1 Setting virtual input 0 to normal state, waiting 200 <b>milliseconds</b> , setting it to trigger state. Note that when the virtual input is waiting for next state,

	state after duration.	it cannot accept new requests.
return	<return page>	Redirect to the page <return page> after the request is completely assigned. The <return page> can be a full URL path or relative path according the current path. If you omit this parameter, it will redirect to an empty page.

Return Code	Description
200	The request is successfully executed.
400	<p>The request cannot be assigned, ex. incorrect parameters.</p> <p>Examples:</p> <p>setvi.cgi?vi0=0(10000)1(15000)0(20000)1</p> <p>No multiple duration.</p> <p>setvi.cgi?vi3=0</p> <p>VI index is out of range.</p> <p>setvi.cgi?vi=1</p> <p>No VI index is specified.</p>
503	<p>The resource is unavailable, ex. Virtual input is waiting for next state.</p> <p>Examples:</p> <p>setvi.cgi?vi0=0(15000)1</p> <p>setvi.cgi?vi0=1</p> <p>Request 2 will not be accepted during the execution time(15 seconds).</p>

## 8.23 Open Timeshift Stream (capability.timeshift > 0, timeshift\_enable=1, timeshift\_c<n>\_s<m>\_allow=1)

**Note:** This request requires Viewer access privileges.

Syntax:

For HTTP push server (MJPEG):

```
http://<servername>/<network_http_s<m>_accessname>?maxsft=<value>[&tsmode=<value>&reftime=<value>&forcechk&minsft=<value>]
```

For RTSP (MP4 and H264), the user needs to input the URL below into an RTSP compatible player.

```
rtsp://<servername>/<network_rtsp_s<m>_accessname>?maxsft=<value>[&tsmode=<value>&reftime=<value>&forcechk&minsft=<value>]
```

“n” is the channel index.

“m” is the timeshift stream index.

For details on timeshift stream, please refer to the “TimeshiftCaching” documents.

PARAMETER	VALUE	DEFAULT	DESCRIPTION
maxsft	<positive interger>	0	Request cached stream at most how many seconds ago.
tsmode	normal, adaptive	normal	Streaming mode: normal => Full FPS all the time. adaptive => Default send only I-frame for MP4 and H.264, and send 1 FPS for MJPEG. If DI or motion window are triggered, the streaming is changed to send full FPS for 10 seconds. (*Note: this parameter also works on non-timeshift streams.)
reftime	mm:ss	The time camera receives the request.	Reference time for maxsft and minsft. (This provides more precise time control to eliminate the inaccuracy due to network latency.) Ex: Request the streaming from 12:20 rtsp://10.0.0.1/live.sdp?maxsft=10&reftime=12:30
forcechk	N/A	N/A	Check if the requested stream enables timeshift, feature and if minsft is achievable. If false, return “415 Unsupported Media Type”.
minsft	<positive interger>	0	How many seconds of cached stream client can accept at

	interger>		least. (Used by forcechk)
--	-----------	--	------------------------------

Return Code	Description
400 Bad Request	Request is rejected because some parameter values are illegal.
415 Unsupported Media Type	Returned, if forcechk appears, when minsft is not achievable or the timeshift feature of the target stream is not enabled.

## 8. 24 Open Anystream (capability.nanystream > 0)

**Note:** This request requires Viewer access privileges.

Syntax:

For HTTP push server (MJPEG):

```
http://<servername>/videoany.mjpg?codectype=mjpeg[&resolution=<value>&mjpeg_quant=<value>&mjpeg_qvalue=<value>&mjpeg_maxframe=<value>]
```

For RTSP (MPEG4), the user needs to input the URL below into an RTSP compatible player.

```
rtsp://<servername>/liveany.sdp?codectype=mpeg4[&resolution=<value>&mpeg4_intraperiod=<value>&mpeg4_ratecontrolmode=<value>&mpeg4_quant=<value>&mpeg4_qvalue=<value>&mpeg4_bitrate=<value>&mpeg4_maxframe=<value>]
```

For RTSP (H264), the user needs to input the URL below into an RTSP compatible player.

```
rtsp://<servername>/liveany.sdp?codectype=h264[&resolution=<value>&h264_intraperiod=<value>&h264_ratecontrolmode=<value>& h264_quant=<value>& h264_qvalue=<value>&h264_bitrate=<value>& h264_maxframe=<value>]
```

<product dependent>

PARAMETER	VALUE	DEFAULT	DESCRIPTION
codectype	mjpeg, mpeg4, h264 <product dependent>	N/A	Set codec type for Anystream.
solution	capability_videoin_resolution <product dependent>	<product dependent>	Video resolution in pixels.
mjpeg_quant	0, 1~5 99, 1~5 <product dependent>	3	Quality of JPEG video. 0,99 is the customized manual input setting. 1 = worst quality, 5 = best quality. <product dependent>
mjpeg_qvalue	10~200	50	Manual video quality level input.



	2~97 <product dependent>	<product dependent>	(This must be present if mjpeg_quant is equal to 0, 99) <product dependent>
mjpeg_maxframe	1~25, 26~30 (only for NTSC or 60Hz CMOS)	15	Set maximum frame rate in fps (for JPEG).
mpeg4_intraperiod	250, 500, 1000, 2000, 3000, 4000	1000	Intra frame period in milliseconds.
mpeg4_ratecontrolmode	cbr, vbr	vbr	cbr: constant bitrate vbr: fix quality
mpeg4_quant	0, 1~5 99, 1~5 <product dependent>	3	Quality of video when choosing vbr in "mpeg4_ratecontrolmode". 0,99 is the customized manual input setting. 1 = worst quality, 5 = best quality. <product dependent>
mpeg4_qvalue	1~31 2~31 <product dependent>	7 <product dependent>	Manual video quality level input. (This must be present if mpeg4_quant is equal to 0, 99) <product dependent> <product dependent>
mpeg4_bitrate	1000~8000000 1000~4000000 <product dependent>	512000 <product dependent>	Set bit rate in bps when choosing cbr in "mpeg4_ratecontrolmode".
mpeg4_maxframe	1~25, 26~30 (only for NTSC or 60Hz CMOS)	10 15 <product dependent>	Set maximum frame rate in fps (for MPEG-4).
h264_intraperiod	250, 500, 1000, 2000, 3000, 4000	1000	Intra frame period in milliseconds.
h264_ratecontrolmode	cbr, vbr	vbr	cbr: constant bitrate vbr: fix quality
h264_quant	0, 1~5 99, 1~5 <product dependent>	3	Quality of video when choosing vbr in "h264_ratecontrolmode". 0,99 is the customized manual input setting. 1 = worst quality, 5 = best quality. <product dependent>
h264_qvalue	0~51 <product dependent>	30 <product dependent>	Manual video quality level input. (This must be present if h264_quant is

		dependent>	equal to 0, 99) <product dependent>
h264_bitrate	1000~8000000 1000~4000000 <product dependent>	512000 <product dependent>	Set bit rate in bps when choosing cbr in "h264_ratecontrolmode".
h264_maxframe	1~25, 26~30 (only for NTSC or 60Hz CMOS)	10 15 <product dependent>	Set maximum frame rate in fps (for H264).

# Technical Specifications

Technical Specifications	
<b>System Information</b>	
CPU	Multimedia SoC (System-on-Chip)
Flash	16 MB
RAM	128 MB
<b>Camera Features</b>	
Image Sensor	1/3" Progressive CMOS
Maximum Resolution	1280x800
Lens Type	Vari-focal
Focal Length	f = 3 ~ 9 mm
Aperture	F1.2 (wide), F2.1 (tele)
Iris	P-iris
Field of View	102.68° ~ 35.4° (horizontal) 61.93° ~ 22.80° (vertical) 122.56° ~ 41.11° (diagonal)
Shutter Time	1/15 sec. to 1/25,000 sec.
WDR Technology	WDR Pro
Day/Night	Removable IR-cut filter for day & night function
Minimum Illumination	0.8 Lux @ F1.2, 50 IRE (Color) 0.001 Lux @ F1.2, 50 IRE (B/W)
Pan/tilt/zoom	ePTZ:
Functionalities	16x digital zoom (4x on IE plug-in, 4x built-in)
IR Illuminators	Built-in IR illuminators, effective up to 20 meters IR LED*18
On-board Storage	MicroSD/SDHC card slot
<b>Video</b>	
Compression	H.264, MJPEG & MPEG-4
Maximum Frame Rate	H.264: 30 fps at 1280x800 MPEG-4: 30 fps at 1280x800 MJPEG: 30 fps at 1280x800
Maximum Streams	2 simultaneous streams
S/N Ratio	Above 60.5 dB
Dynamic Range	110.4 dB
Video Streaming	Adjustable resolution, quality and bitrate Configurable video cropping for bandwidth saving
Image Settings	Adjustable image size, quality and bit rate Time stamp, text overlay, flip & mirror Configurable brightness, contrast, saturation, sharpness, white balance, exposure control, gain, backlight compensation, privacy masks Scheduled profile settings
<b>Audio</b>	
Audio Capability	Audio input/output (half duplex)
Compression	GSM-AMR, AAC, G.711
Interface	External microphone input External line output
<b>Network</b>	
Users	Live viewing for up to 10 clients
Protocols	IPv4, IPv6, TCP/IP, HTTP, HTTPS, UPnP, RTSP/RTMP/RTCP, IGMP, SMTP, FTP, DHCP, NTP, DNS, DDNS, PPPoE, CoS, QoS, SNMP, 802.1X
Interface	10Base-T/100 BaseTX Ethernet (RJ-45)
ONVIF	Ver. 1.02
<b>Intelligent Video</b>	
Video Motion Detection	Triple-window video motion detection
<b>Alarm and Event</b>	
Alarm Triggers	Video motion detection, manual trigger, digital input, periodical trigger, system boot, recording notify, camera tampering detection
Alarm Events	Event notification using digital output, HTTP, SMTP, FTP and NAS server File upload via HTTP, SMTP, FTP and NAS server
<b>General</b>	
Smart Focus System	Focus assist OSD (Network streaming)
Connectors	RJ-45 for Network/PoE connection 3.5 mm phone jack*2 for audio input/output Terminal block*2 for AC 24V power input Terminal block*4 for digital input*3 Terminal block*2 for digital output*1 MicroSD/SDHC card slot
LED Indicator	System power and status indicator
Power Input	24V AC IEEE 802.3af PoE Class 3
Power Consumption	Max. 8.0W
Dimensions	Ø: 173 mm x 115 mm
Weight	Net: 1414 g
Casing	Vandal-proof IK10-rated metal housing Weather-proof IP66-rated housing
Safety Certifications	CE, LVD, FCC Class A, VCCI, C-Tick
Operating Temperature	-20°C ~ 50°C (-4°F ~ 122°F)
Warranty	24 months
<b>System Requirements</b>	
Operating System	Microsoft Windows 7/Vista/XP/2000
Web Browser	Mozilla Firefox 7 ~ 10 (streaming only) Internet Explorer 7.x or 8.x
Other Players	VLC: 1.1.11 or above QuickTime: 7 or above
<b>Included Accessories</b>	
CD	User's manual, quick installation guide, Installation Wizard 2, ST7501 32-channel recording software
Others	Quick installation guide, warranty card, mounting plate, alignment sticker, ceiling hole template sticker, L-type hex key wrench, silica gel, screws, hex nut, double-sided tape, AV cable, waterproof connector & bushing
<b>Dimensions</b>	

## Compatible Accessories

### Mounting Kits



**AM-518**  
Outdoor dome adapter

### PoE Kits



**MS-POE-IJAF**  
PoE Injector, 802.3af Compliant

All specifications are subject to change without notice. Copyright © VIVOTEK INC. All rights reserved.

Distributed by:



**VIVOTEK INC.**  
6F, No.192, Lien-Cheng Rd., Chung-Ho,  
New Taipei City, 235, Taiwan, R.O.C.  
T: +886-2-82455282 F: +886-2-82455532  
E: sales@vivotek.com

**VIVOTEK USA**  
2050 Ringwood Avenue,  
San Jose, CA 95131  
T: 408-773-8686 F: 408-773-8298  
E: salesusa@vivotek.com

**VIVOTEK Europe**  
Busplein 36, 1315KV,  
Almere, The Netherlands  
T: +31(0)36-5389-149 F: +31(0)36-5389-111  
E: saleseurope@vivotek.com

Ver 1.3

## Technology License Notice

### MPEG-4 AAC Technology

THIS PRODUCT IS LICENSED UNDER THE MPEG-4 AAC AUDIO PATENT LICENSE. THIS PRODUCT MAY NOT BE DECOMPILED, REVERSE-ENGINEERED OR COPIED, EXCEPT WITH REGARD TO PC SOFTWARE, OF WHICH YOU MAY MAKE SINGLE COPIES FOR ARCHIVAL PURPOSES. FOR MORE INFORMATION, PLEASE REFER TO [HTTP://WWW.VIALICENSING.COM](http://www.vialicensing.com).

### MPEG-4 Visual Technology

THIS PRODUCT IS LICENSED UNDER THE MPEG-4 VISUAL PATENT PORTFOLIO LICENSE FOR THE PERSONAL AND NON-COMMERCIAL USE OF A CONSUMER FOR (i) ENCODING VIDEO IN COMPLIANCE WITH THE MPEG-4 VISUAL STANDARD ("MPEG-4 VIDEO") AND/OR (ii) DECODING MPEG-4 VIDEO THAT WAS ENCODED BY A CONSUMER ENGAGED IN A PERSONAL AND NON-COMMERCIAL ACTIVITY AND/OR WAS OBTAINED FROM A VIDEO PROVIDER LICENSED BY MPEG LA TO PROVIDE MPEG-4 VIDEO. NO LICENSE IS GRANTED OR SHALL BE IMPLIED FOR ANY OTHER USE. ADDITIONAL INFORMATION INCLUDING THAT RELATING TO PROMOTIONAL, INTERNAL AND COMMERCIAL USES AND LICENSING MAY BE OBTAINED FROM MPEG LA, LLC. PLEASE REFER TO [HTTP://WWW.MPEGLA.COM](http://www.mpegla.com).

### AMR-NB Standard

THIS PRODUCT IS LICENSED UNDER THE AMR-NB STANDARD PATENT LICENSE AGREEMENT. WITH RESPECT TO THE USE OF THIS PRODUCT, THE FOLLOWING LICENSORS' PATENTS MAY APPLY:

TELEFONAKIEBOLAGET ERICSSON AB: US PAT. 6192335; 6275798; 6029125; 6424938; 6058359. NOKIA CORPORATION: US PAT. 5946651; 6199035. VOICEAGE CORPORATION: AT PAT. 0516621; BE PAT. 0516621; CA PAT. 2010830; CH PAT. 0516621; DE PAT. 0516621; DK PAT. 0516621; ES PAT. 0516621; FR PAT. 0516621; GB PAT. 0516621; GR PAT. 0516621; IT PAT. 0516621; LI PAT. 0516621; LU PAT. 0516621; NL PAT. 0516621; SE PAT. 0516621; US PAT. 5444816; AT PAT. 819303/AT E 198805T1; AU PAT. 697256; BE PAT. 819303; BR PAT. 9604838-7; CA PAT. 2216315; CH PAT. 819303; CN PAT. ZL96193827.7; DE PAT. 819303/DE69611607T2; DK PAT. 819303; ES PAT. 819303; EP PAT. 819303; FR PAT. 819303; GB PAT. 819303; IT PAT. 819303; JP PAT. APP. 8-529817; NL PAT. 819303; SE PAT. 819303; US PAT. 5664053. THE LIST MAY BE UPDATED FROM TIME TO TIME BY LICENSORS AND A CURRENT VERSION OF WHICH IS AVAILABLE ON LICENSOR'S WEBSITE AT [HTTP://WWW.VOICEAGE.COM](http://www.voiceage.com).

## Electromagnetic Compatibility (EMC)

### FCC Statement

This device complies with FCC Rules Part 15. Operation is subject to the following two conditions.

- This device may not cause harmful interference, and
- This device must accept any interference received, including interference that may cause undesired operation.

This equipment has been tested and found to comply with the limits for a Class B digital device, pursuant to Part 15 of the FCC Rules. These limits are designed to provide reasonable protection against harmful interference in a residential installation. This equipment generates, uses and can radiate radio frequency energy and, if not installed and used in accordance with the instructions, may cause harmful interference to radio communications. However, there is no guarantee that interference will not occur in a partial installation. If this equipment does cause harmful interference to radio or television reception, which can be determined by turning the equipment off and on, the user is encouraged to try to correct the interference by one or more of the following measures:

- Reorient or relocate the receiving antenna.
- Increase the separation between the equipment and receiver.
- Connect the equipment into an outlet on a circuit different from that to which the receiver is connected.
- Consult the dealer or an experienced radio/TV technician for help.

Shielded interface cables must be used in order to comply with emission limits.

### CE Mark Warning

This is a Class B product. In a domestic environment, this product may cause radio interference, in which case the user may be required to take adequate measures.

### VCCI Warning

この装置は、情報処理装置等電波障害自主規制協議会（VCCI）の基準に基づくクラスB情報技術装置です。この装置は、家庭環境で使用することを目的としていますが、この装置がラジオやテレビジョン受信機に近接して使用されると、受信障害を引き起こすことがあります。

取扱説明書に従って正しい取り扱いをして下さい

### Liability

VIVOTEK Inc. cannot be held responsible for any technical or typographical errors and reserves the right to make changes to the product and manuals without prior notice. VIVOTEK Inc. makes no warranty of any kind with regard to the material contained within this document, including, but not limited to, the implied warranties of merchantability and fitness for any particular purpose.