

User's Manual

IP7161

2-megapixel • Day & Night

Network Camera



Table of Contents

Overview	3
Read Before Use.....	3
Package Contents.....	3
Physical Description.....	4
Installation	6
Hardware Installation.....	6
Network Deployment.....	7
Software Installation.....	10
Ready to Use.....	11
Accessing the Network Camera	12
Using Web Browsers.....	12
Using RTSP Players.....	14
Using 3GPP-compatible Mobile Devices.....	15
Using VIVOTEK Recording Software.....	16
Main Page	17
Client Settings	21
Configuration	23
System.....	24
Security.....	26
HTTPS.....	27
SNMP.....	32
Network.....	33
DDNS.....	48
Access List.....	50
Audio and Video.....	53
Motion Detection.....	65
Camera Tampering Detection.....	68
Camera Control.....	69
Homepage Layout.....	76
Application.....	79
Recording.....	92
Local Storage.....	95
System Log.....	99
View Parameters.....	100
Maintenance.....	101
Appendix	105
URL Commands for the Network Camera.....	105
Technical Specifications.....	162
Technology License Notice.....	163
Electromagnetic Compatibility (EMC).....	164

Overview

VIVOTEK IP7161 is a high-end 2-megapixel network camera with true day and night functions, ideally suited for wide open spaces such as building entrances and airports, or applications requiring accurate identification, such as human faces in banks or vehicle license plates in parking lots. With advanced 2-megapixel (1600 x 1200) resolution, the IP7161 can not only deliver extremely clear and detailed images, but also capture much larger areas of scenes that CCTV cameras cannot. Consequently, users can significantly reduce deployment costs by using a megapixel camera instead of multiple VGA models.

To consistently maintain superior image quality during 24-hour surveillance, the IP7161 comes with a built-in removable IR-cut filter for the acceptance of IR illumination and auto-iris lens for frequent light changes. For safe and secure monitoring, the IP7161 also supports tamper detection so that security staff can be alerted immediately if the camera is blocked, redirected, defocused, or spray-painted. The exceptional time-shift streaming feature stores pre- and post-event images temporarily on a buffer memory in the camera, giving the user a view of events leading up to and after incidents.

Additionally, the IP7161 camera incorporates an adjustment ring to improve the lens compatibility for either C- or CS-mount lens, with a design that provides system integrators with more flexibility and simpler installation for different applications. In order to facilitate convenient on-board storage and data portability, the camera also provides an SD/SDHC card slot for temporary recording and data storage.

The IP7161 includes other advanced features such as simultaneous dual streams, 802.3af compliant PoE, two-way audio via SIP protocol and HTTPS encrypted data transmission.

Read Before Use

The use of surveillance devices may be prohibited by law in your country. The Network Camera is not only a high-performance web-ready camera but can also be part of a flexible surveillance system. It is the user's responsibility to ensure that the operation of such devices is legal before installing this unit for its intended use.

It is important to first verify that all contents received are complete according to the Package Contents listed below. Take note of the warnings in the Quick Installation Guide before the Network Camera is installed; then carefully read and follow the instructions in the Installation chapter to avoid damage due to faulty assembly and installation. This also ensures the product is used properly as intended.

The Network Camera is a network device and its use should be straightforward for those who have basic networking knowledge. It is designed for various applications including video sharing, general security/surveillance, etc. The Configuration chapter suggests ways to best utilize the Network Camera and ensure proper operations. For creative and professional developers, the URL Commands of the Network Camera section serves as a helpful reference to customizing existing homepages or integrating with the current web server.

Package Contents

- IP7161
- Power Adapter
- Camera Stand
- CS-mount Lens
- Software CD
- Warranty Card
- Quick Installation Guide
- L-type Hex Key Wrench

Physical Description

Front Panel

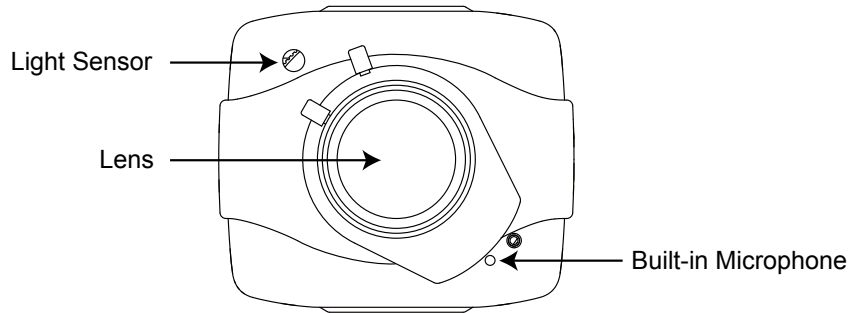

Back Panel

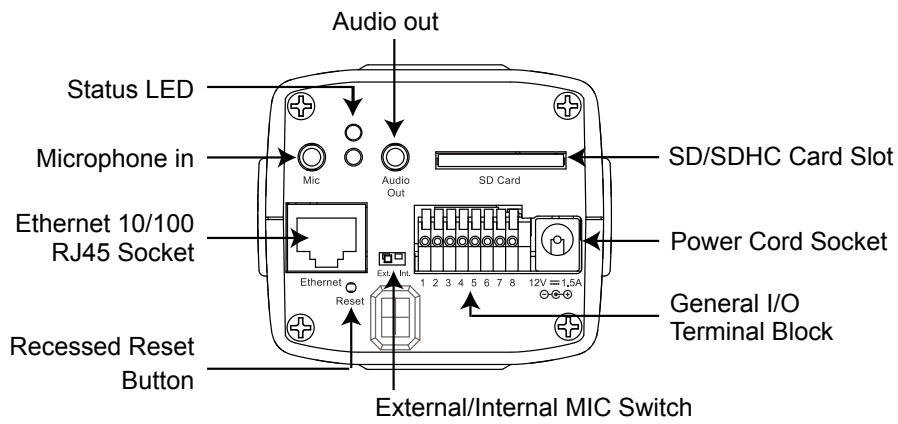

Lens

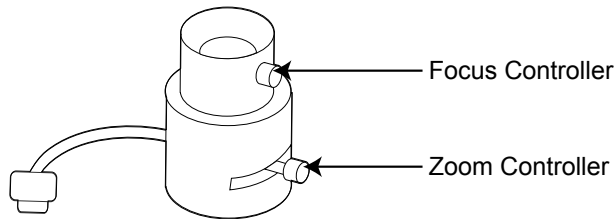

General I/O Terminal Block

This Network Camera provides a general I/O terminal block which is used to connect external input / output devices. The pin definitions are described below.

Pin	Name
1	Power +12V
2	Digital Output
3	Digital Input
4	Ground
5	AC 24V input
6	AC 24V input
7	RS-485 +
8	RS-485 -

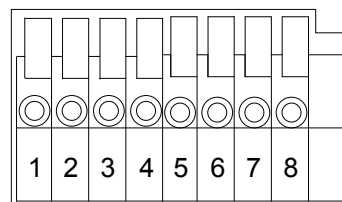

DI/DO Diagram

Refer to the following illustration for the connection method.

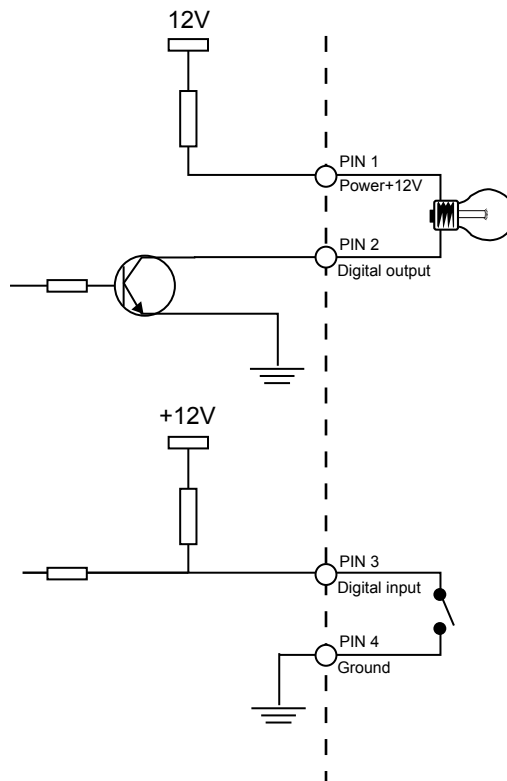

Status LED

The LED indicates the status of the Network Camera.

Item	LED status	Description
1	Steady Red	Power on and system booting
	Red LED unlighted	Power off
2	Steady Red + Blink Green every 1 sec.	Network works (heartbeat)
	Steady Red + Green LED unlighted	Network fail
3	Steady Red + Blink Green every 2 sec.	Audio mute (heartbeat)
4	Blink Red every 0.15 sec. + Blink Green every 1 sec.	Upgrading Firmware
5	Blink Red every 0.15 sec. + Blink Green every 0.15 sec.	Restore default

Hardware Reset

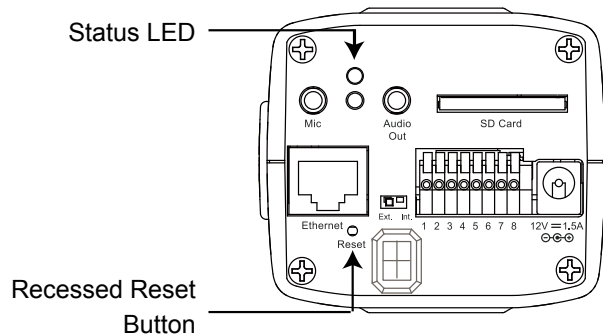

The reset button is used to reset the system or restore the factory default settings. Sometimes resetting the system can return the camera to normal operation. If the system problems remain after reset, restore the factory settings and install again.

Reset: Press and release the recessed reset button with a paper clip or thin object. Wait for the Network Camera to reboot.

Restore: Press and hold the recessed reset button until the status LED rapidly blinks. It takes about 30 seconds. Note that all settings will be restored to factory default. Upon successful restore, the status LED will blink green and red during normal operation.

SD/SDHC Card Capacity

This network camera is compliant with **SD/SDHC 16GB / 8GB** and other preceding standard SD cards.

Installation

Hardware Installation

Follow the steps below to mount the lens to the Network Camera:

1. Mount the lens by turning it clockwise onto the camera mount until it stops. If necessary, turn the lens counterclockwise slowly until it gets the best attitude.
2. Connect the lens cable plug to the camera connector.

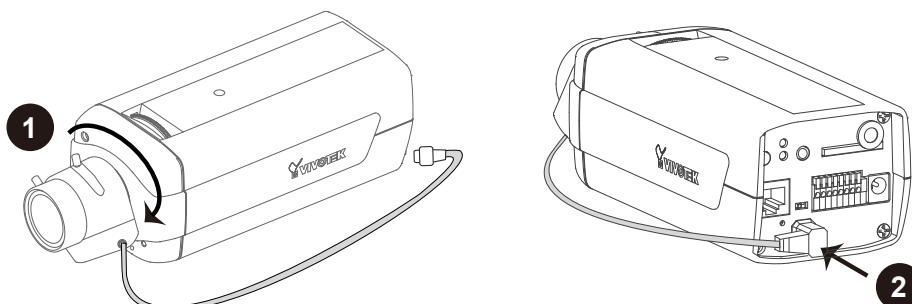

Network Deployment

Setting up the Network Camera over the Internet

This section explains how to configure the Network Camera to an Internet connection.

1. If you have external devices such as sensors and alarms, connect them to the general I/O terminal block.
2. Connect the camera to a switch via Ethernet cable.
3. Connect the power cable from the Network Camera to a power outlet.

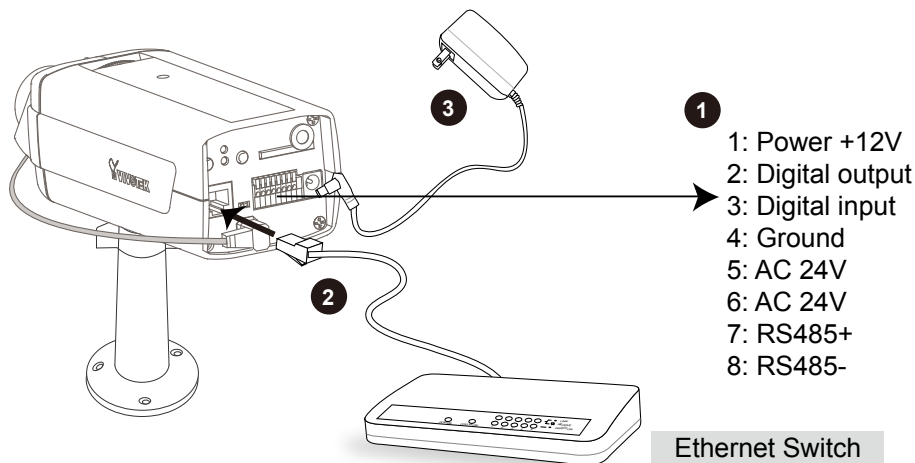

There are several ways to set up the Network Camera over the Internet. The first way is to set up the Network Camera behind a router. The second way is to utilize a static IP. The third way is to use PPPoE.

Internet connection via a router

Before setting up the Network Camera over the Internet, make sure you have a router and follow the steps below.

1. Connect your Network Camera behind a router, the Internet environment is illustrated below. Regarding how to obtain your IP address, please refer to Software Installation on page 10 for details.

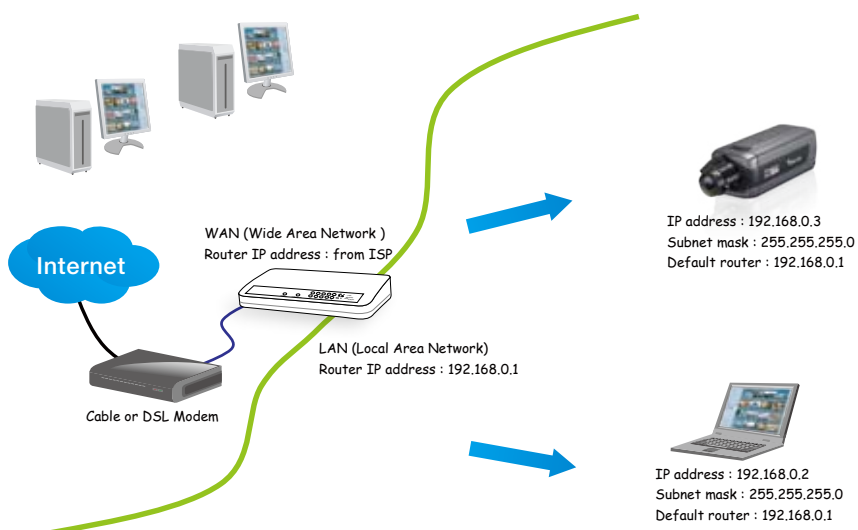

2. In this case, if the Local Area Network (LAN) IP address of your Network Camera is 192.168.0.3, please forward the following ports for the Network Camera on the router.

- HTTP port
- RTSP port
- RTP port for audio
- RTCP port for audio
- RTP port for video
- RTCP port for video

If you have changed the port numbers on the Network page, please open the ports accordingly on your router. For information on how to forward ports on the router, please refer to your router's user's manual.

3. Find out the public IP address of your router provided by your ISP (Internet Service Provider). Use the public IP and the secondary HTTP port to access the Network Camera from the Internet. Please refer to Network Type on page 33 for details.

Internet connection with static IP

Choose this connection type if you are required to use a static IP for the Network Camera. Please refer to LAN on page 33 for details.

Internet connection via PPPoE (Point-to-Point over Ethernet)

Choose this connection type if you are connected to the Internet via a DSL Line. Please refer to PPPoE on page 34 for details.

Set up the Network Camera through Power over Ethernet (PoE)

When using a PoE-enabled switch

The Network Camera is PoE-compliant, allowing transmission of power and data via a single Ethernet cable. Follow the below illustration to connect the Network Camera to a PoE-enabled switch via Ethernet cable.

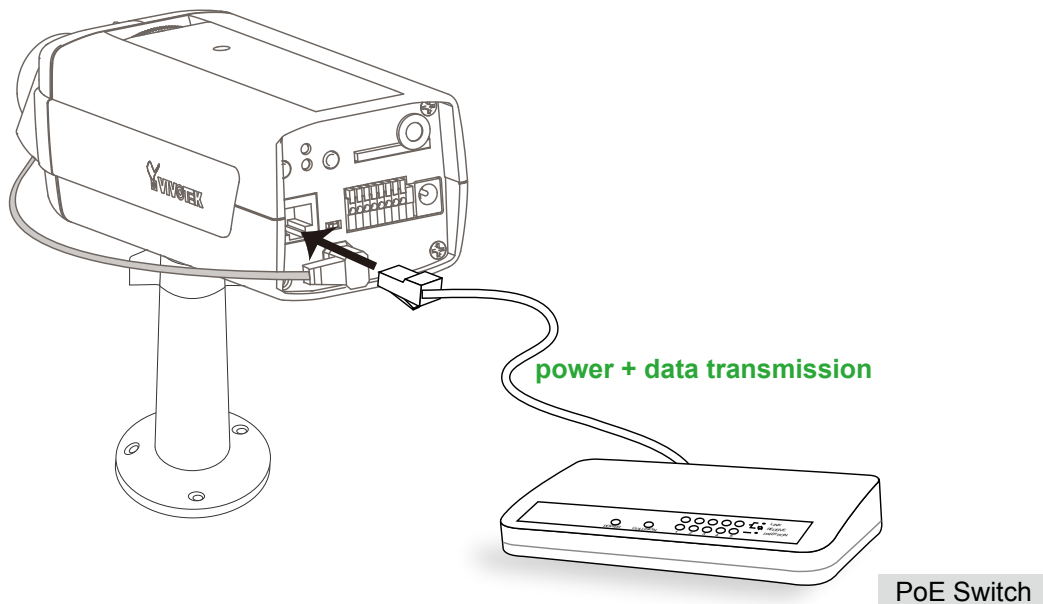

When using a non-PoE switch

If your switch/router does not support PoE, use a PoE power injector (optional) to connect between the Network Camera and a non-PoE switch.

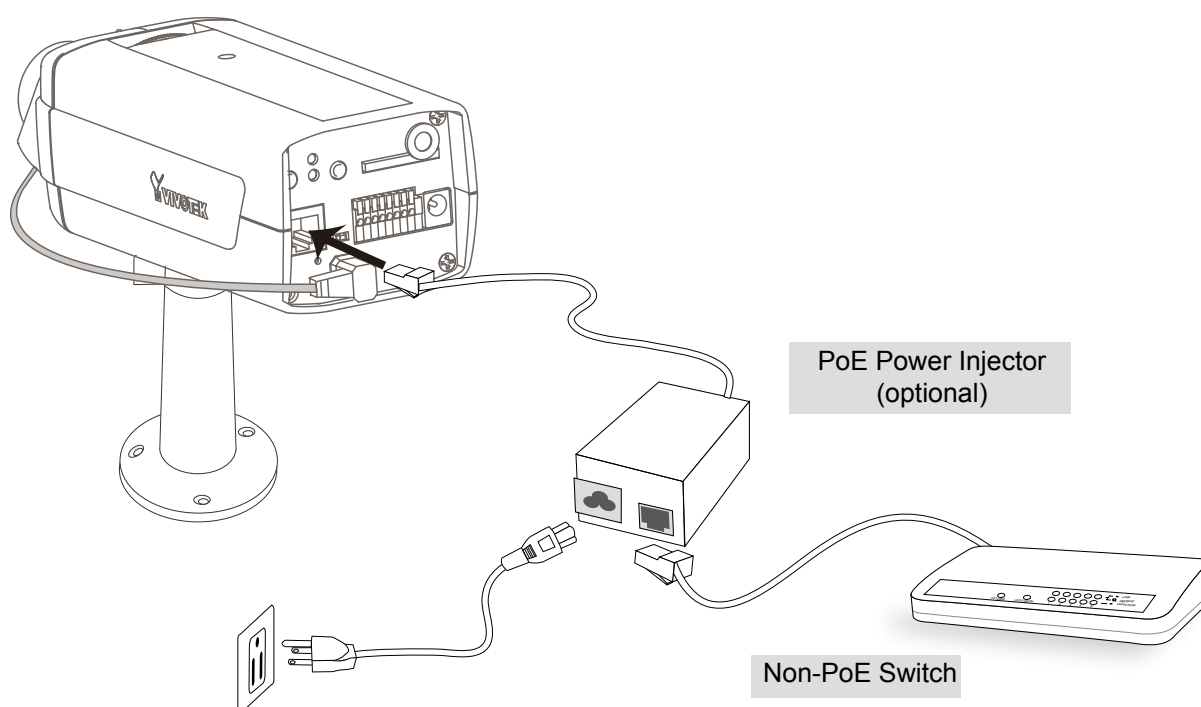

Software Installation

Installation Wizard 2 (IW2), free-bundled software included on the product CD, helps you set up your Network Camera on the LAN.

1. Install IW2 under the Software Utility directory from the software CD.
Double click the IW2 shortcut on your desktop to launch the program.



2. The program will conduct an analysis of your network environment.
After your network environment is analyzed, please click Next to continue the program.



3. The program will search for all VIVOTEK network device devices on the same LAN.
4. After searching, the main installer window will pop up. Click on the MAC and model name which matches the product label on your device to connect to the Network Camera via Internet Explorer.

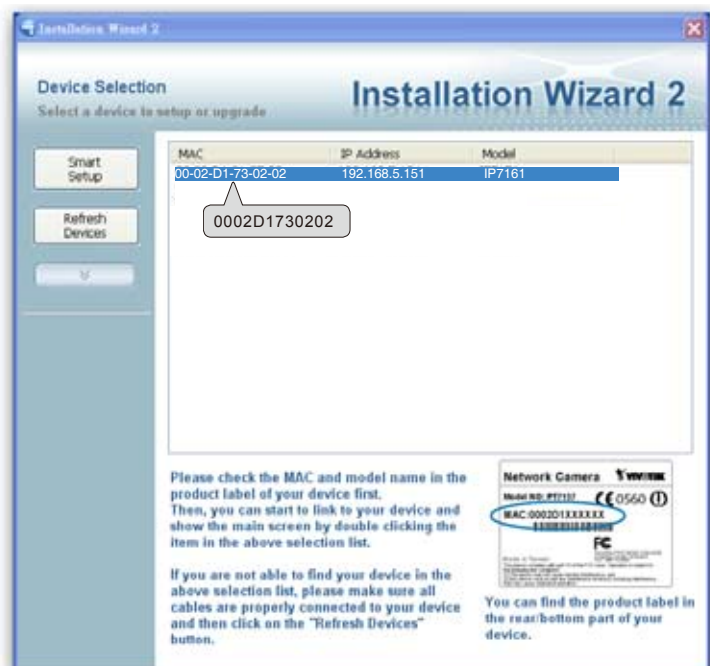

Ready to Use

1. Access the Network Camera on the LAN.
2. Retrieve live video through a web browser or recording software.

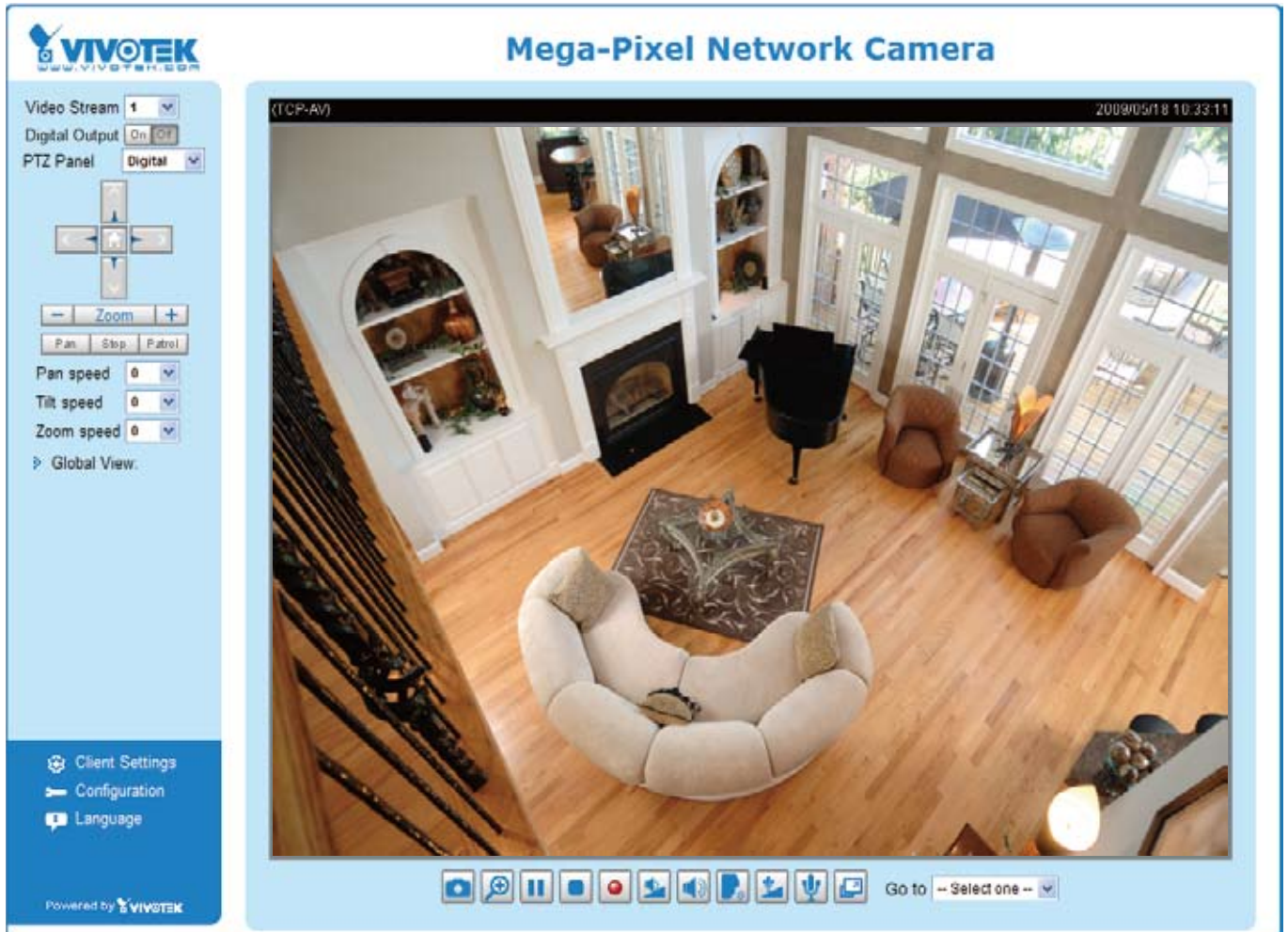

Accessing the Network Camera

This chapter explains how to access the Network Camera through web browsers, RTSP players, 3GPP-compatible mobile devices, and VIVOTEK recording software.

Using Web Browsers

Use Installation Wizard 2 (IW2) to access to the Network Cameras on the LAN.

If your network environment is not a LAN, follow these steps to access the Network Camera:

1. Launch your web browser (ex. Microsoft® Internet Explorer, Mozilla Firefox, or Netscape).
2. Enter the IP address of the Network Camera in the address field. Press **Enter**.
3. The live video will be displayed in your web browser.
4. If it is the first time installing the VIVOTEK network camera, an information bar will pop up as shown below. Follow the instructions to install the required plug-in on your computer.

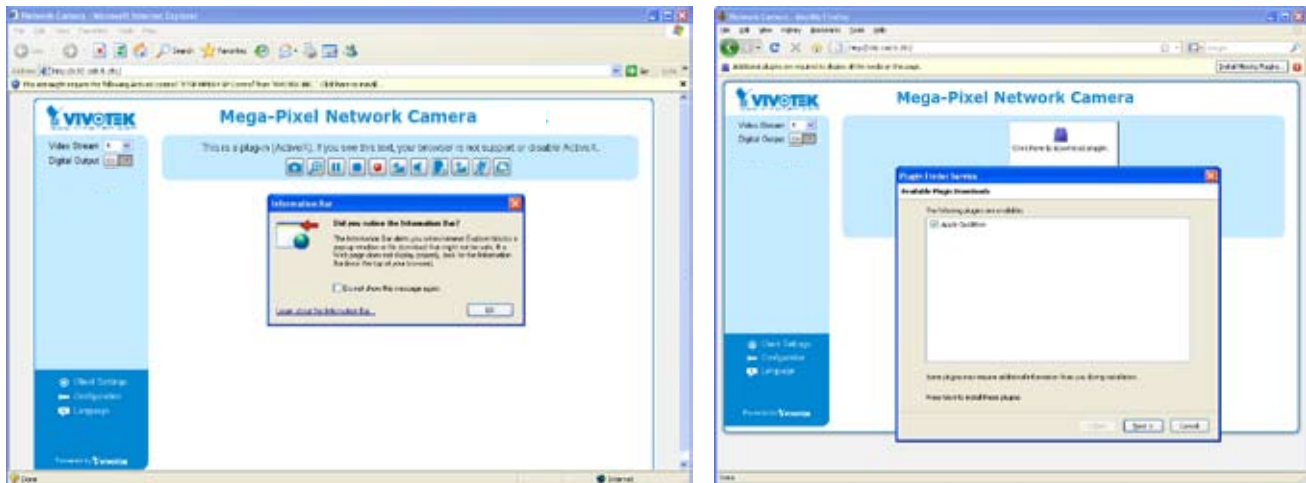

NOTE

- For Mozilla Firefox or Netscape users, your browser will use Quick Time to stream the live video. If you don't have Quick Time on your computer, please download it first, then launch the web browser.

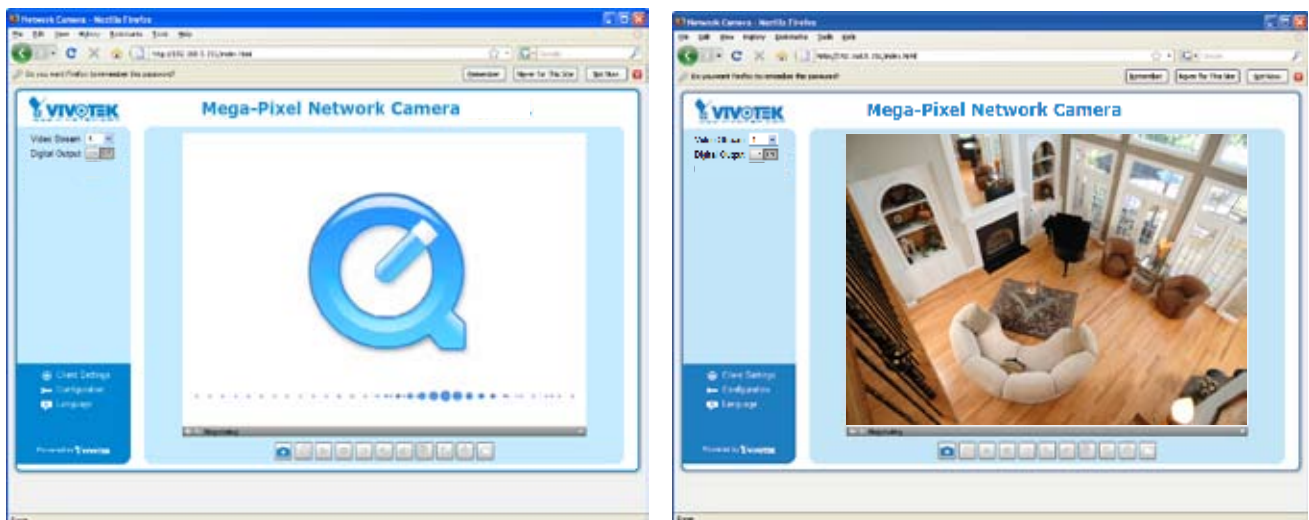

- ▶ *By default, the Network Camera is not password-protected. To prevent unauthorized access, it is highly recommended to set a password for the Network Camera. For more information about how to enable password protection, please refer to Security on page 26.*
- ▶ *If you see a dialog box indicating that your security settings prohibit running ActiveX® Controls, please enable the ActiveX® Controls for your browser.*

1. Choose **Tools > Internet Options > Security > Custom Level**.

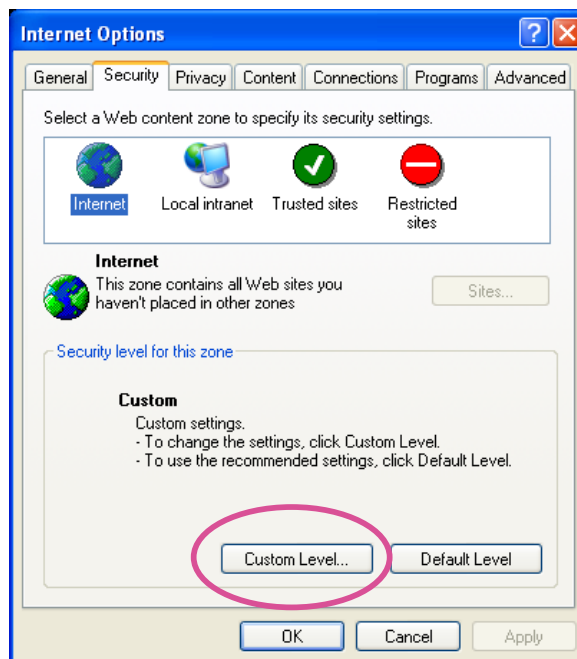

2. Look for **Download signed ActiveX® controls**; select **Enable or Prompt**. Click **OK**.

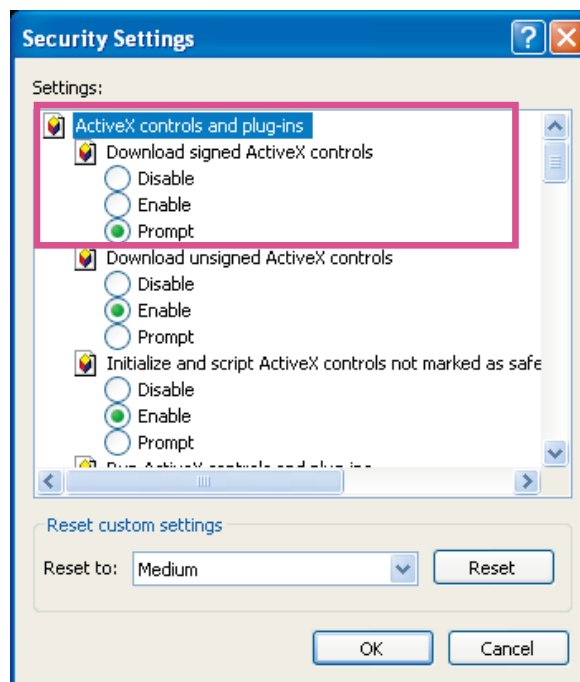

3. Refresh your web browser, then install the Active X® control. Follow the instructions to complete installation.

Using RTSP Players

To view the MPEG-4 streaming media using RTSP players, you can use one of the following players that support RTSP streaming.



Quick Time Player



Real Player

1. Launch the RTSP player.
2. Choose File > Open URL. A URL dialog box will pop up.
3. The address format is `rtsp://<ip address>:<rtsp port>/<RTSP streaming access name for stream1 or stream2>`

As most ISPs and players only allow RTSP streaming through port number 554, please set the RTSP port to 554. For more information, please refer to RTSP Streaming on page 46.

For example:

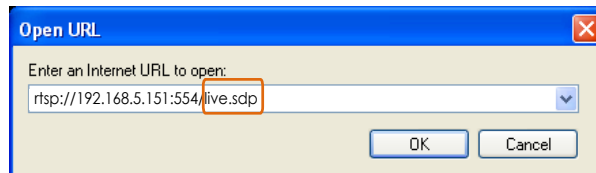

4. The live video will be displayed in your player.
For more information on how to configure the RTSP access name, please refer to RTSP Streaming on page 46 for details.

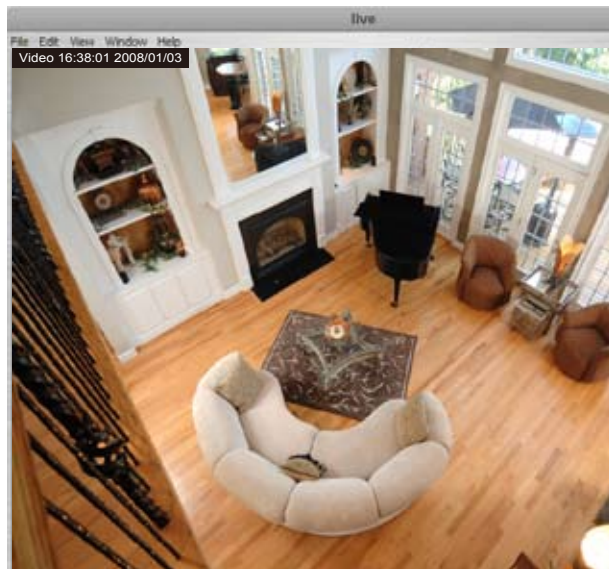

Using 3GPP-compatible Mobile Devices

To view the streaming media through 3GPP-compatible mobile devices, make sure the Network Camera can be accessed over the Internet. For more information on how to set up the Network Camera over the Internet, please refer to Setup the Network Camera over the Internet on page 7.

To utilize this feature, please check the following settings on your Network Camera:

1. Because most players on 3GPP mobile phones do not support RTSP authentication, make sure the authentication mode of RTSP streaming is set to disable.
For more information, please refer to RTSP Streaming on page 46.
2. As the the bandwidth on 3G networks is limited, you will not be able to use a large video size. Please set the video and audio streaming parameters as listed below.
For more information, please refer to Viewing Window on page 59.

Video Mode	MPEG-4
Frame size	176 x 144
Maximum frame rate	5 fps
Intra frame period	1S
Video quality (Constant bit rate)	40kbps
Audio type (GSM-AMR)	12.2kbps

3. As most ISPs and players only allow RTSP streaming through port number 554, please set the RTSP port to 554. For more information, please refer to RTSP Streaming on page 46.
4. Launch the player on the 3GPP-compatible mobile devices (ex. Real Player).
5. Type the following URL commands in the player.
The address format is `rtsp://<public ip address of your camera>:<rtsp port>/<RTSP streaming access name for stream 3>`.
For example:

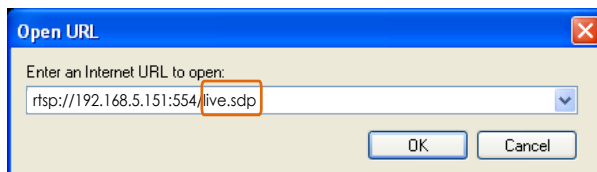

Using VIVOTEK Recording Software

The product software CD also contains recording software, allowing simultaneous monitoring and video recording for multiple Network Cameras. Please install the recording software; then launch the program to add the Network Camera to the Channel list. For detailed information about how to use the recording software, please refer to the user's manual of the software or download it from <http://www.vivotek.com>.



Main Page

This chapter explains the layout of the main page. It is composed of the following sections: VIVOTEK INC. Logo, Host Name, Camera Control Area, Configuration Area, Menu, and Live Video Window.

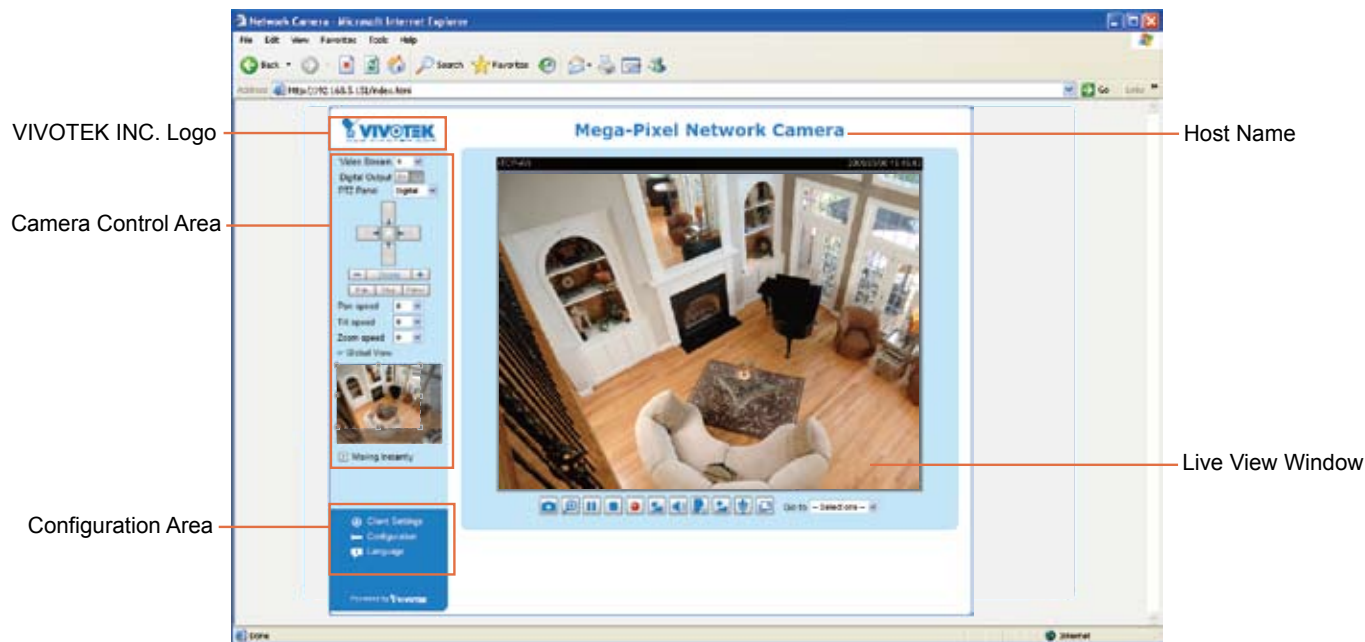

VIVOTEK INC. Logo

Click this logo to visit the VIVOTEK website.

Host Name

The host name can be customized to fit your needs. For more information, please refer to System on page 24.

Camera Control Area

Video Stream: This Network Camera supports multiple streams (stream 1 ~ 4) simultaneously. You can select either one for live viewing. For more information about multiple streams, please refer to page 59 for detailed information.

Digital Output: Click to turn the digital output device on or off.

PTZ Panel: This Network Camera supports both “digital” (e-PTZ) and “mechanical” pan/tilt/zoom control. Please refer to Camera Control on page 69 for detailed information.

Global View: Click on this item to display the Global View window. The Global View window contains a full view image (the largest frame size of the captured video) and a floating frame (the viewing region of the current video stream). The floating frame allows users to control the e-PTZ function (Electronic Pan/Tilt/Zoom). For more information about e-PTZ operation, please refer to E-PTZ Operation on page 74. For more information about how to set up the viewing region of the current video stream, please refer to Viewing Windows on page 59.

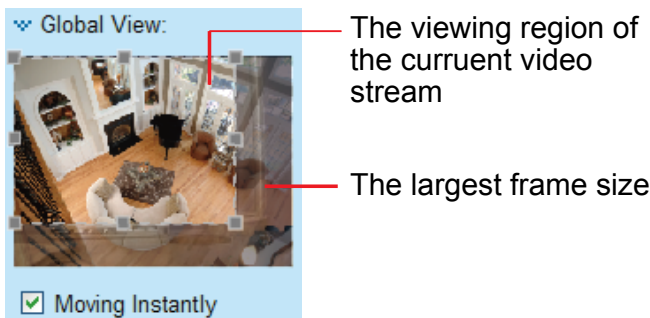

Configuration Area

Client Settings: Click this button to access the client setting page. For more information, please refer to Client Settings on page 21.

Configuration: Click this button to access the configuration page of the Network Camera. It is suggested that a password be applied to the Network Camera so that only the administrator can configure the Network Camera. For more information, please refer to Configuration on page 23.

Language: Click this button to choose a language for the user interface. Language options are available in: English, Deutsch, Español, Français, Italiano, 日本語, Português, 簡體中文, and 繁體中文.

Live Video Window

■ The following window is displayed when the video mode is set to MPEG-4:



Video Title: The video title can be configured. For more information, please refer to Video Settings on page 53.

MPEG-4 Protocol and Media Options: The transmission protocol and media options for MPEG-4 video streaming. For further configuration, please refer to Client Settings on page 21.

Time: Display the current time. For further configuration, please refer to Video Settings on page 53.



Title and Time: The video title and time can be stamped on the streaming video. For further configuration, please refer to Video Settings on page 53.



Video and Audio Control Buttons: Depending on the Network Camera model and Network Camera configuration, some buttons may not be available.

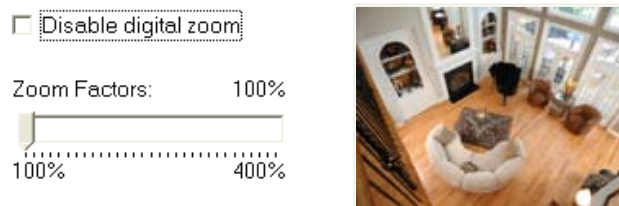

Snapshot: Click this button to capture and save still images. The captured images will be displayed in a pop-up window. Right-click the image and choose **Save Picture As** to save it in JPEG (*.jpg) or BMP (*.bmp) format.



Digital Zoom: Click and uncheck “Disable digital zoom” to enable the zoom operation. The navigation screen indicates the part of the image being magnified. To control the zoom level, drag the slider bar. To move to a different area you want to magnify, drag the navigation screen.







 **Pause:** Pause the transmission of the streaming media. The button becomes the  Resume button after clicking the Pause button.



 **Stop:** Stop the transmission of the streaming media. Click the  Resume button to continue transmission.



 **Start MP4 Recording:** Click this button to record video clips in MP4 file format to your computer. Press the  Stop MP4 Recording button to end recording. When you exit the web browser, video recording stops accordingly. To specify the storage destination and file name, please refer to MP4 Saving Options on page 22 for details.

 **Volume:** When the  Mute function is not activated, move the slider bar to adjust the volume on the local computer.

 **Mute:** Turn off the volume on the local computer. The button becomes the  Audio On button after clicking the Mute button.

 **Talk:** Click this button to talk to people around the Network Camera. Audio will project from the external speaker connected to the Network Camera. Click this button  again to end talking transmission.

 **Mic Volume:** When the  Mute function is not activated, move the slider bar to adjust the microphone volume on the local computer.

 **Mute:** Turn off the  Mic volume on the local computer. The button becomes the  Mic On button after clicking the Mute button.

 **Full Screen:** Click this button to switch to full screen mode. Press the “Esc” key to switch back to normal mode.

■ The following window is displayed when the video mode is set to MJPEG:

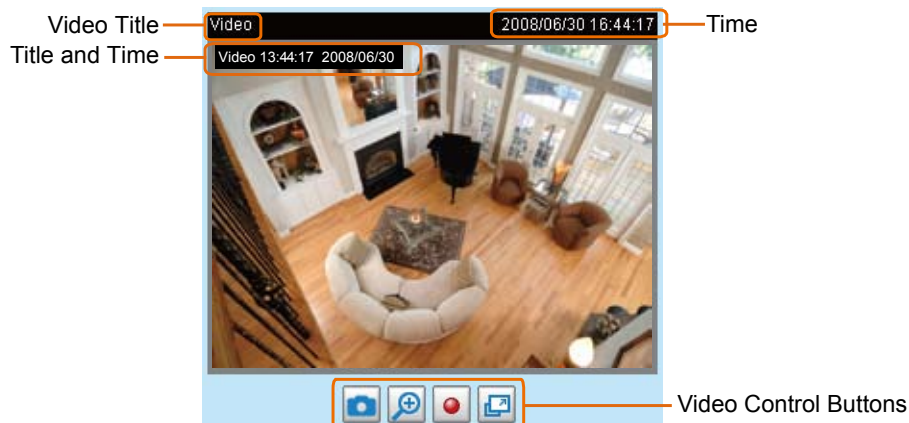



Video Title: The video title can be configured. For more information, please refer to Video Settings on page 53.

Time: Display the current time. For more information, please refer to Video Settings on page 53.



Title and Time: Video title and time can be stamped on the streaming video. For more information, please refer to Video Settings on page 53.

Video and Audio Control Buttons: Depending on the Network Camera model and Network Camera configuration, some buttons may not be available.

 **Snapshot:** Click this button to capture and save still images. The captured images will be displayed in a pop-up window. Right-click the image and choose **Save Picture As** to save it in JPEG (*.jpg) or BMP (*.bmp) format.

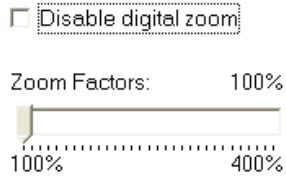
 **Digital Zoom:** Click and uncheck “Disable digital zoom” to enable the zoom operation. The navigation screen indicates the part of the image being magnified. To control the zoom level, drag the slider bar. To move to a different area you want to magnify, drag the navigation screen.



 **Start MP4 Recording:** Click this button to record video clips in MP4 file format to your computer. Press the  **Stop MP4 Recording** button to end recording. When you exit the web browser, video recording stops accordingly. To specify the storage destination and file name, please refer to MP4 Saving Options on page 22 for details.

 **Full Screen:** Click this button to switch to full screen mode. Press the “Esc” key to switch back to normal mode.

Client Settings

This chapter explains how to select the stream transmission mode and saving options on the local computer. When completed with the settings on this page, click **Save** on the page bottom to enable the settings.

MPEG-4 Media Options

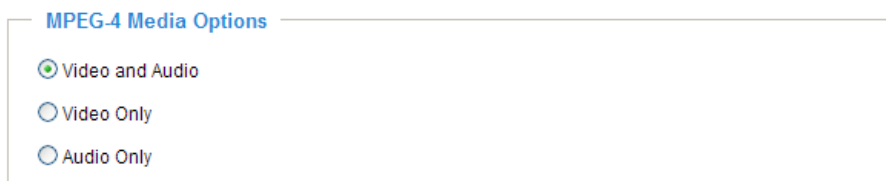

MPEG-4 Media Options

- Video and Audio
- Video Only
- Audio Only

Select to stream video or audio data or both. This is enabled only when the video mode is set to MPEG-4.

MPEG-4 Protocol Options

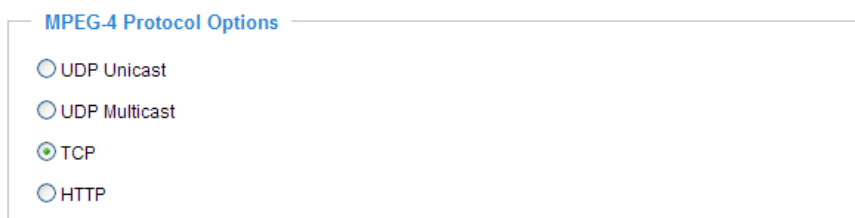

MPEG-4 Protocol Options

- UDP Unicast
- UDP Multicast
- TCP
- HTTP

Depending on your network environment, there are four transmission modes of MPEG-4 streaming:

UDP unicast: This protocol allows for more real-time audio and video streams. However, network packets may be lost due to network burst traffic and images may be broken. Activate UDP connection when occasions require time-sensitive responses and the video quality is less important. Note that each unicast client connecting to the server takes up additional bandwidth and the Network Camera allows up to ten simultaneous accesses.

UDP multicast: This protocol allows multicast-enabled routers to forward network packets to all clients requesting streaming media. This helps to reduce the network transmission load of the Network Camera while serving multiple clients at the same time. Note that to utilize this feature, the Network Camera must be configured to enable multicast streaming at the same time. For more information, please refer to RTSP Streaming on page 46.

TCP: This protocol guarantees the complete delivery of streaming data and thus provides better video quality. The downside of this protocol is that its real-time effect is not as good as that of the UDP protocol.

HTTP: This protocol allows the same quality as TCP protocol without needing to open specific ports for streaming under some network environments. Users inside a firewall can utilize this protocol to allow streaming data through.

MP4 Saving Options

MP4 Saving Options

Folder:

File name prefix:

Add date and time suffix to file name

Users can record live video as they are watching it by clicking  Start MP4 Recording on the main page. Here, you can specify the storage destination and file name.

Folder: Specify a storage destination for the recorded video files.

File name prefix: Enter the text that will be appended to the front of the video file name.

Add date and time suffix to the file name: Select this option to append the date and time to the end of the file name.

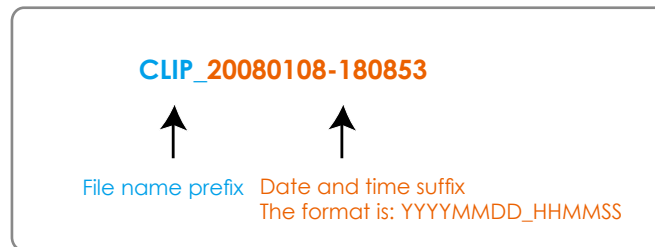

Configuration

Click **Configuration** on the main page to enter the camera setting pages. Note that only Administrators can access the configuration page.

VIVOTEK offers an easy-to-use user interface that helps you set up your network camera with minimal effort. To simplify the setting procedure, two types of user interfaces are available: Advanced Mode for professional users and Basic Mode for entry-level users. Some advanced functions (HTTPS/ Access list/ Homepage layout/ Application/ Recording/ System log/ View parameters) are not displayed in Basic Mode.

If you want to set up advanced functions, please click **[Advanced Mode]** on the bottom of the configuration list to quickly switch to Advanced Mode.

In order to simplify the user interface, the detailed information will be hidden unless you click on the function item. When you click on the first sub-item, the detailed information for the first sub-item will be displayed; when you click on the second sub-item, the detailed information for the second sub-item will be displayed and that of the first sub-item will be hidden.

The following is the interface of the Basic Mode and the Advanced Mode:

Basic Mode

The screenshot displays the VIVOTEK configuration web interface. On the left is a blue sidebar menu with the following items: Home, System, Security, Network, DDNS, Audio and video, Motion detection, Camera tampering detection, Camera control, and Maintenance. The 'System' item is selected. At the bottom of the sidebar, there is a button labeled '[Advanced mode]'. The main content area has a blue header with the VIVOTEK logo and 'www.vivotek.com' on the left, and 'Configuration' on the right. Below the header is a blue bar with '>System'. The main content area contains three sections: 'System' with a text input for 'Host name' (Mega-Pixel Network Camera) and a checkbox for 'Turn off the LED indicator'; 'Configuration List' with a sub-section 'System Time' containing radio buttons for 'Keep current date and time' (selected), 'Synchronize with computer time', 'Manual', and 'Automatic'; and 'DI and DO' with two rows of digital input/output settings, each with a dropdown menu for 'active state' and a text label for 'current state detected'. A 'Save' button is located at the bottom left of the main content area. At the bottom left of the sidebar, the text 'Version: 0101a' is displayed. Several orange callout boxes and arrows point to these elements: one around the sidebar menu, one around the '[Advanced mode]' button, one around the 'Version: 0101a' text, and one pointing to the 'Configuration List' section.

Advanced Mode

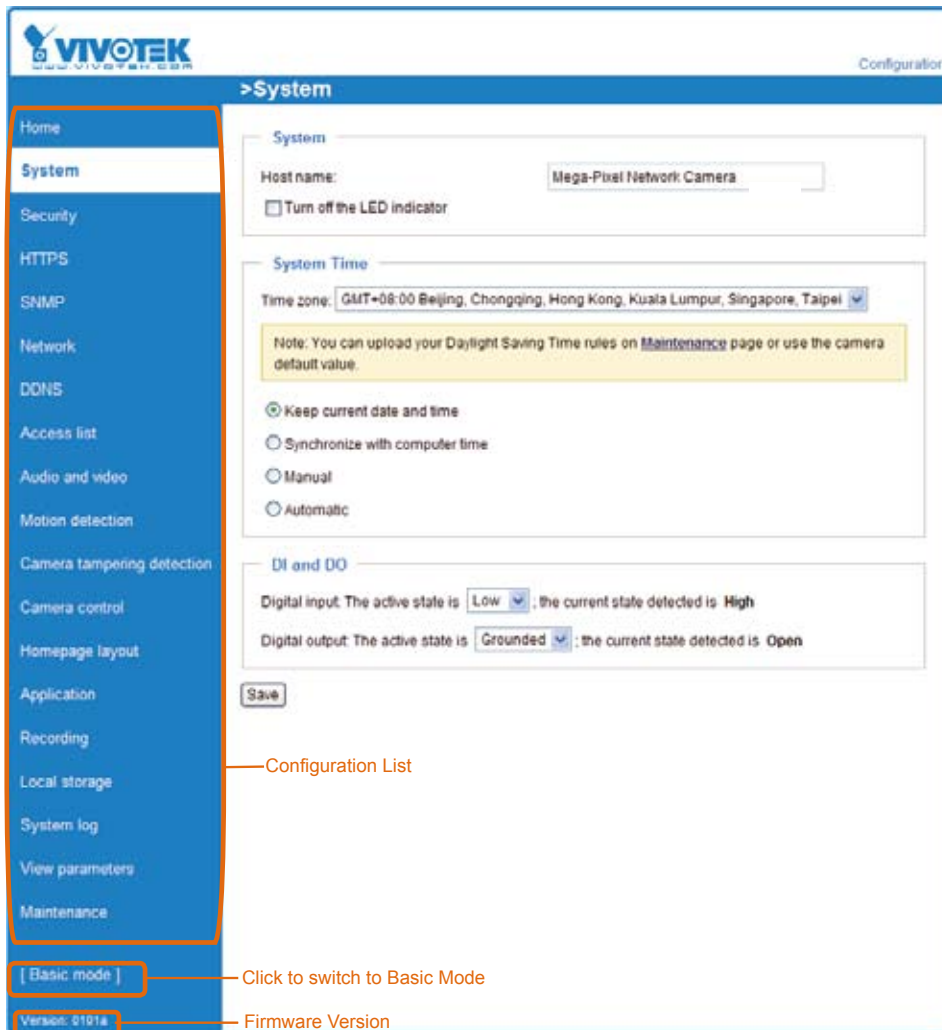

Each function on the configuration list will be explained in the following sections. Those functions that are displayed only in Advanced Mode are marked with **Advanced Mode**. If you want to set up advanced functions, please click **[Advanced Mode]** on the bottom of the configuration list to quickly switch over.

System

This section explains how to configure the basic settings for the Network Camera, such as the host name and system time. It is composed of the following three columns: System, System Time and DI and DO. When finished with the settings on this page, click **Save** at the bottom of the page to enable the settings.

System

System

Host name:

Turn off the LED indicator

Host name: Enter a desired name for the Network Camera. The text will be displayed at the top of the main page.

Turn off the LED indicators: If you do not want to let others know that the network camera is in operation, you can select this option to turn off the LED indicators.

System Time

System Time

Time zone: GMT+08:00 Beijing, Chongqing, Hong Kong, Kuala Lumpur, Singapore, Taipei ▼

Note: You can upload your Daylight Saving Time rules on [Maintenance](#) page or use the camera default value.

Keep current date and time

Sync with computer time:

Manual:

Automatic:

Keep current date and time: Select this option to preserve the current date and time of the Network Camera. The Network Camera's internal real-time clock maintains the date and time even when the power of the system is turned off.

Sync with computer time: Select this option to synchronize the date and time of the Network Camera with the local computer. The read-only date and time of the PC is displayed as updated.

Manual: The administrator can enter the date and time manually. Note that the date and time format are [yyyy/mm/dd] and [hh:mm:ss].

Automatic: The Network Time Protocol is a protocol which synchronizes computer clocks by periodically querying an NTP Server.

NTP server: Assign the IP address or domain name of the time-server. Leaving the text box blank connects the Network Camera to the default time servers.

Update interval: Select to update the time using the NTP server on an hourly, daily, weekly, or monthly basis.

Time zone Advanced Mode: Select the appropriate time zone from the list. If you want to upload Daylight Savings Time rules on the Maintenance page, please refer to Upload / Export Daylight Saving Time Configuration File on page 102 for details.

DI and DO

DI and DO

Digital input: The active state is Low ▼; the current state detected is **High**

Digital output: The active state is Grounded ▼; the current state detected is **Open**

Save

Digital input: Select High or Low to define normal status for the digital input. The Network Camera will report the current status.

Digital output: Select Grounded or Open to define normal status for the digital output. The Network Camera will show whether the trigger is activated or not.

Security

This section explains how to enable password protection and create multiple accounts.

Root Password

The administrator account name is “root”, which is permanent and can not be deleted. If you want to add more accounts in the Manage User column, please apply the password for the “root” account first.

1. Type the password identically in both text boxes, then click **Save** to enable password protection.
2. A window will be prompted for authentication; type the correct user’s name and password in their respective fields to access the Network Camera.

Manage Privilege **Advanced Mode**

	Operator	Viewer
Digital Output:	<input checked="" type="checkbox"/>	<input type="checkbox"/>
PTZ control:	<input checked="" type="checkbox"/>	<input checked="" type="checkbox"/>

Allow anonymous viewing

Digital Output & PTZ control: You can modify the manage privilege of operators or viewers. Check or uncheck the item, then click **Save** to enable the settings. If you give Viewers the privilege, Operators will also have the ability to control the Network Camera through the main page. (Please refer to Main Page on page 17.)

Allow anonymous viewing: If you check this item, any client can access the live stream without entering a User ID and Password.

Manage User

Administrators can add up to 20 user accounts.

1. Input the new user’s name and password.
2. Select the privilege level for the new user account. Click **Add** to enable the setting.

Access rights are sorted by user privilege (Administrator, Operator, and Viewer). Only administrators can access the Configuration page. Though operators cannot access the Configuration page, they can use the URL Commands to get and set the value of parameters. For more information, please refer to URL Commands of the Network Camera on page 105. Viewers access only the main page for live viewing.

Here you also can change a user’s access rights or delete user accounts.

1. Select an existing account to modify.
2. Make necessary changes and click **Update** or **Delete** to enable the setting.

HTTPS (Hypertext Transfer Protocol over SSL) Advanced Mode

This section explains how to enable authentication and encrypted communication over SSL (Secure Socket Layer). It helps protect streaming data transmission over the Internet on higher security level.

Enable HTTPS

Check this item to enable HTTPS communication, then select a connection option: "HTTP & HTTPS" or "HTTPS only". Note that you have to create and install a certificate first in the second column before clicking the **Save** button.

Enable HTTPS

*To enable HTTPS, you have to create and install certificate first.

Enable HTTPS secure connection:

HTTP & HTTPS
 HTTPS only

Save

Create and install certificate method

Create self-signed certificate automatically

Create self-signed certificate manually:

Create certificate request and install:

Create and Install Certificate Method

Before using HTTPS for communication with the Network Camera, a **Certificate** must be created first. There are three ways to create and install a certificate:

Create self-signed certificate automatically

1. Select this option.
2. In the first column, check **Enable HTTPS secure connection**, then select a connection option: "HTTP & HTTPS" or "HTTPS only".
3. Click **Save** to generate a certificate.

Enable HTTPS

*To enable HTTPS, you have to create and install certificate first.

Enable HTTPS secure connection:

HTTP & HTTPS
 HTTPS only

Save

Create and install certificate method

Create self-signed certificate automatically

Create self-signed certificate manually:

Create certificate request and install:

Certificate Information

Status: Not installed

Please wait while the certificate is being generated...

4. The Certificate Information will automatically be displayed in the third column as shown below. You can click **Property** to view detailed information about the certificate.

Certificate Information

Status:	Active
Country:	TW
State or province:	Asia
Locality:	Asia
Organization:	Vivotek.Inc
Organization Unit:	Vivotek.Inc
Common Name:	www.vivotek.com

5. Click **Home** to return to the main page. Change the address from “<http://>” to “<https://>” in the address bar and press **Enter** on your keyboard. Some Security Alert dialogs will pop up. Click **OK** or **Yes** to enable HTTPS.

https://

The screenshot shows the Vivotek web interface in Internet Explorer. The address bar is highlighted with a red box and labeled 'https://'. A 'Security Alert' dialog box is open, displaying the message: 'You are about to view pages over a secure connection. Any information you exchange with this site cannot be viewed by anyone else on the Web. In the future, do not show this warning'. The background shows a live video feed of a room with a fireplace and a chair.

Security Alert

Information you exchange with this site cannot be viewed or changed by others. However, there is a problem with the site's security certificate.

- The security certificate was issued by a company you have not chosen to trust. View the certificate to determine whether you want to trust the certifying authority.
- The security certificate date is valid.
- The name on the security certificate is invalid or does not match the name of the site

Do you want to proceed?

Security Information

This page contains both secure and nonsecure items.

Do you want to display the nonsecure items?

Create self-signed certificate manually

1. Select this option.
2. Click **Create** to open the Create Certificate page, then click **Save** to generate the certificate.

Create and install certificate method

Create self-signed certificate automatically
 Create self-signed certificate manually:
 Self-signed certificate:
 Create certificate request and install:

Create Certificate

Country:

State or province:

Locality:

Organization:

Organization Unit:

Common Name:

Validity: days

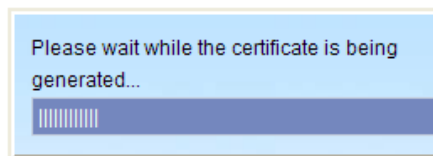

3. The Certificate Information will automatically be displayed in the third column as shown below. You can click **Property** to see detailed information about the certificate.

Certificate Information

Status:

Country: TW

State or province: Asia

Locality: Asia

Organization: Vivotek.Inc

Organization Unit: Vivotek.Inc

Common Name: www.vivotek.com

Create certificate and install : Select this option if you want to create a certificate from a certificate authority.

1. Select this option.
2. Click **Create** to open the Create Certificate page, then click **Save** to generate the certificate.

Create and install certificate method

Create self-signed certificate automatically
 Create self-signed certificate manually:
 Create certificate request and install:
 Certificate request:
 Select certificate file:

Create Certificate

Country:

State or province:

Locality:

Organization:

Organization Unit:

Common Name:

Validity: days

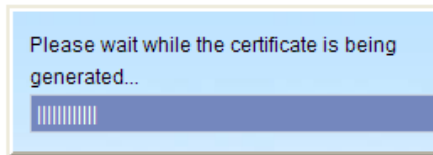

3. If you see the following Information bar, click **OK** and click on the Information bar at the top of the page to allow pop-ups.

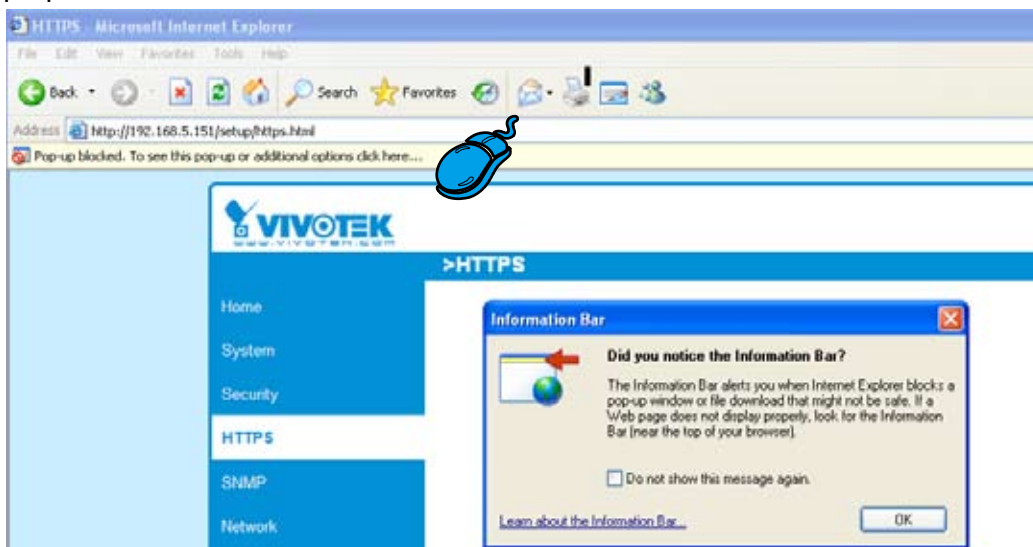

4. The pop-up window shows an example of a certificate request.

Create Certificate Request Completed

Copy the PEM format request below and send it to a CA for identify validation. After that, you have to install it by clicking the "Upload" button on HTTPS page.

Certificate Request (PEM format)

```

-----BEGIN CERTIFICATE REQUEST-----
MIIBuDCASECADB5MQswCQYDVQQGEwJUVzERMA8GA1UECBMIUHJvdmluY2UxEjAQ
BgNVBAsTCUNpdHkgTmFtZTEaMBgGA1UEChMRMjM3JnYw5pemFOaW9uIE5hbWUxEjAQ
BgNVBAsTCVVuaXQgTmFtZTEaMBgGA1UEAxMKSVAgQWRkcmVzcCBnzANBgkqhkiG
9w0BAQEFAAOBjQAwgYkCgYEAuOT75EY52gsSyPFMxZ7wHdQ1obPescsXLUx9DFw6
OMRheukFaXFDkM+5xk+K5oEPBPqj77yhH+zdUHS27fFSLG57bW9S0xrWuLhSvR2W
mCD+//AiJX864dJ/mjHn7Mc55GFaxgMvbALcxT+hCIeDCWYnRqh/fpKNj+BxvVoN
UrcCAwEAAaAAMAOGCSqGSIB3DQEBBQUAA4GBAAVazWOAtftfU9dyFgTxOYD1D/zO
FOTkbnDQG18e4ftJ3rROD1TvIIMjg3K8zsA38Gd3pME1ejqLYoBrtasQdCUqG1X
50bLG1subWsxr88PngaBwjYoTpG3q1zvUPJZLAVmdL3ne5urTbABXOScCHOQgtH+
PX9dw4OJWkIC8QhV
-----END CERTIFICATE REQUEST-----
    
```

5. Look for a trusted certificate authority that issues digital certificates. Enroll the Network Camera. Wait for the certificate authority to issue a SSL certificate; click **Browse...** to search for the issued certificate, then click Upload in the second column.

Create and install certificate method

Create self-signed certificate automatically
 Create self-signed certificate manually:
 Create certificate request and install:

Certificate request:
 Select certificate file:

Certificate Information

Status: ▼

NOTE

► How do I cancel the HTTPS settings?

1. Uncheck **Enable HTTPS secure connection** in the first column and click **Save**; a warning dialog will pop up.
2. Click **OK** to disable HTTPS.

Enable HTTPS

*To enable HTTPS, you have to create and install certificate first.

Enable HTTPS secure connection:

Create and install certificate method

Create self-signed certificate automatically
 Create self-signed certificate manually:

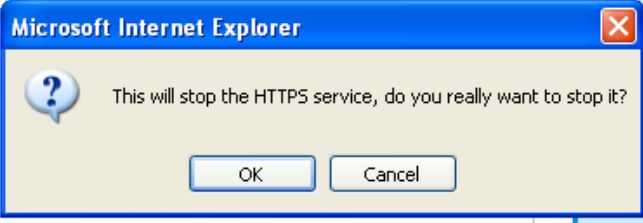

3. The webpage will redirect to a non-HTTPS page automatically.

► If you want to create and install other certificates, please remove the existing one. To remove the signed certificate, uncheck **Enable HTTPS secure connection** in the first column and click **Save**. Then click **Remove** to erase the certificate.

Certificate Information

Status: ▼

Country:

State or province:

Locality:

Organization:

Organization Unit:

Common Name:

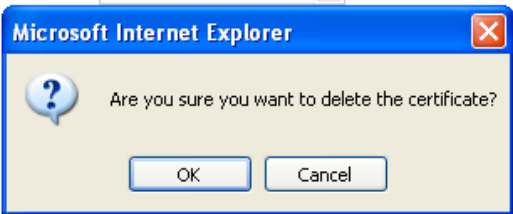

SNMP (Simple Network Management Protocol) Advanced Mode

This section explains how to use the SNMP on the network camera. The Simple Network Management Protocol is an application layer protocol that facilitates the exchange of management information between network devices. It helps network administrators to remotely manage network devices and find, solve network problems with ease.

■ The SNMP consists of the following three key components:

1. Manager: Network-management station (NMS), a server which executes applications that monitor and control managed devices.
2. Agent: A network-management software module on a managed device which transfers the status of managed devices to the NMS.
3. Managed device: A network node on a managed network. For example: routers, switches, bridges, hubs, computer hosts, printers, IP telephones, network cameras, web server, and database.

Before configuring SNMP settings on the this page, please enable your NMS first.

SNMP Configuration

Enable SNMPv1, SNMPv2c

Select this option and enter the names of Read/Write community and Read Only community according to your NMS settings.

Enable SNMPv1, SNMPv2c

SNMPv1, SNMPv2c Settings

Read/Write community:

Read only community:

Enable SNMPv3

This option contains cryptographic security, a higher security level, which allows you to set the Authentication password and the Encryption password.

- Security name: According to your NMS settings, choose Read/Write or Read Only and enter the community name.
- Authentication type: Select MD5 or SHA as the authentication method.
- Authentication password: Enter the password for authentication (at least 8 characters).
- Encryption password: Enter a password for encryption (at least 8 characters).

Enable SNMPv3

SNMPv3 Settings

Read/Write Security name:

Authentication Type:

Authentication Password:

Encryption Password:

Read only Security name:

Authentication Type:

Authentication Password:

Encryption Password:

Network

This section explains how to configure a wired network connection for the Network Camera.

Network Type

Network Type

LAN:

- Get IP address automatically
- Use fixed IP address:
- Enable UPnP presentation
- Enable UPnP port forwarding

PPPoE:

- Enable IPv6

LAN

Select this option when the Network Camera is deployed on a local area network (LAN) and is intended to be accessed by local computers. The default setting for the Network Type is LAN. Remember to click **Save** when you complete the Network setting.

Get IP address automatically: Select this option to obtain an available dynamic IP address assigned by the DHCP server each time the camera is connected to the LAN.

Use fixed IP address: Select this option to manually assign a static IP address to the Network Camera.

Network Type

LAN:

- Get IP address automatically
- Use fixed IP address:

IP address:	192.168.5.109
Subnet mask:	255.255.255.0
Default router:	192.168.5.1
Primary DNS:	192.168.0.10
Secondary DNS:	192.168.0.20
Primary WINS server:	
Secondary WINS server:	

- Enable UPnP presentation
- Enable UPnP port forwarding

PPPoE:

- Enable IPv6

1. You can make use of VIVOTEK Installation Wizard 2 on the software CD to easily set up the Network Camera on LAN. Please refer to Software Installation on page 10 for details.
2. Enter the Static IP, Subnet mask, Default router, and Primary DNS provided by your ISP.

Enable UPnP presentation: Select this option to enable UPnP™ presentation for your Network Camera so that whenever a Network Camera is presented to the LAN, shortcuts of connected Network Cameras will be listed in My Network Places. You can click the shortcut to link to the web browser. Currently, UPnP™ is supported by Windows XP or later. Note that to utilize this feature, please make sure the UPnP™ component is installed on your computer.

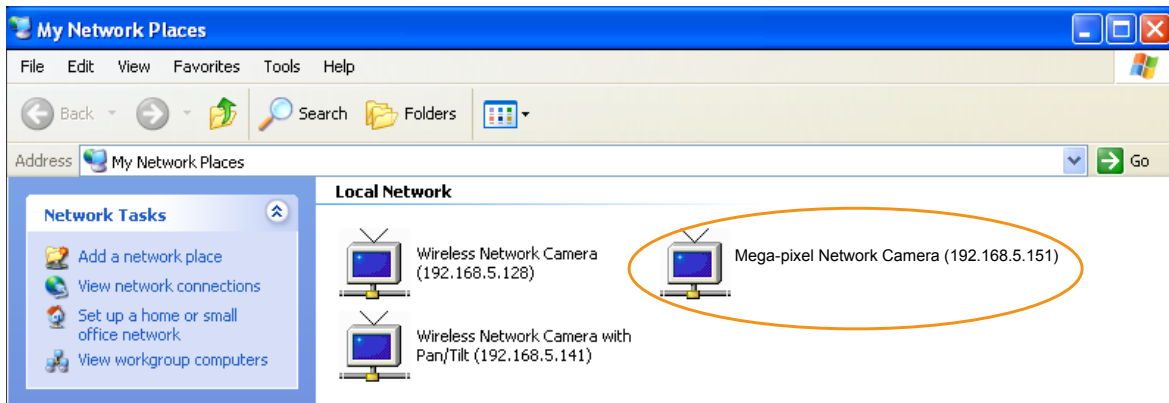

Enable UPnP port forwarding: To access the Network Camera from the Internet, select this option to allow the Network Camera to open ports on the router automatically so that video streams can be sent out from a LAN. To utilize of this feature, make sure that your router supports UPnP™ and it is activated.

PPPoE (Point-to-point over Ethernet)

Select this option to configure your Network Camera to make it accessible from anywhere as long as there is an Internet connection. Note that to utilize this feature, it requires an account provided by your ISP.

Follow the steps below to acquire your Network Camera's public IP address.

1. Set up the Network Camera on the LAN.
2. Go to Home > Configuration > Application > Server Settings (please refer to Server Settings on page 85) to add a new email or FTP server.
3. Go to Configuration > Application > Media Settings (please refer to Media Settings on page 88). Select System log so that you will receive the system log in TXT file format which contains the Network Camera's public IP address in your email or on the FTP server.
4. Go to Configuration > Network > Network Type. Select PPPoE and enter the user name and password provided by your ISP. Click **Save** to enable the setting.

Network Type

LAN:

PPPoE:

User name:

Password:

Confirm password:

5. The Network Camera will reboot.
6. Disconnect the power to the Network Camera; remove it from the LAN environment.

NOTE

- ▶ If the default ports are already used by other devices connected to the same router, the Network Camera will select other ports for the Network Camera.
- ▶ If UPnP™ is not supported by your router, you will see the following message:
Error: Router does not support UPnP port forwarding.

- **Steps to enable the UPnP™ user interface on your computer:**
 Note that you must log on to the computer as a system administrator to install the UPnP™ components.

1. Go to Start, click **Control Panel**, then click **Add or Remove Programs**.

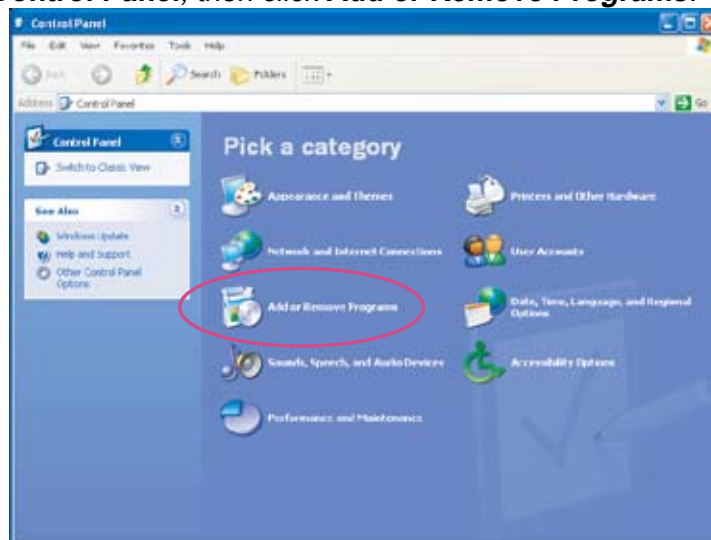

2. In the Add or Remove Programs dialog box, click **Add/Remove Windows Components**.

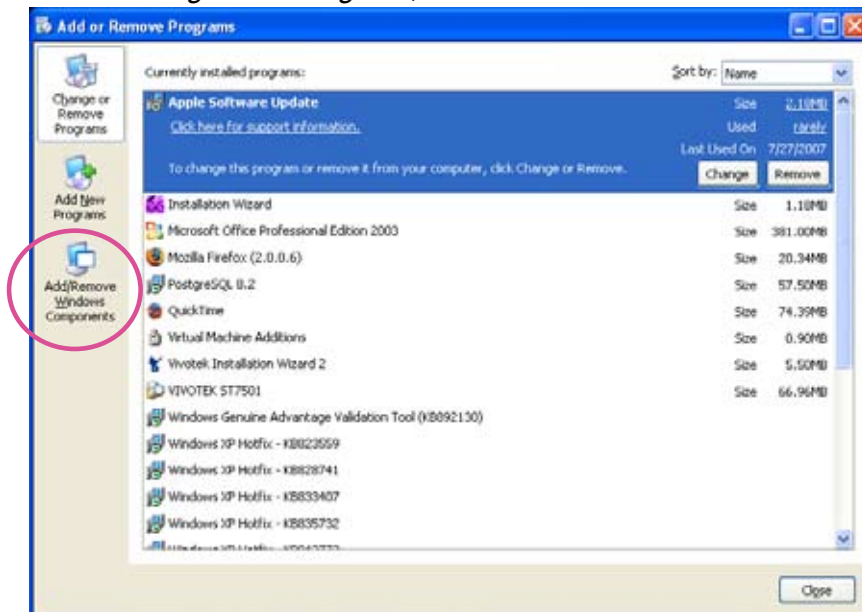

3. In the Windows Components Wizard dialog box, select **Networking Services** and click **Details**.

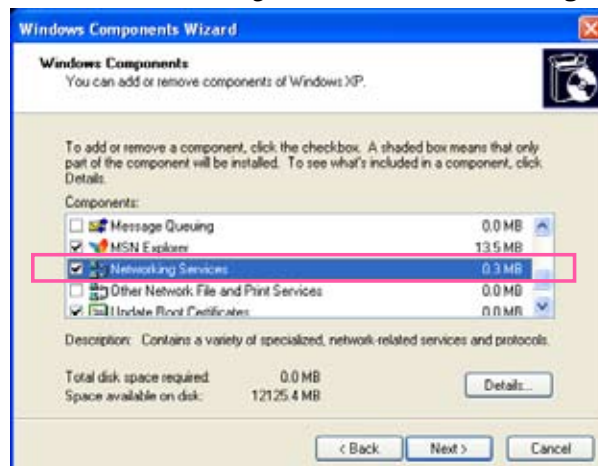

4. In the Networking Services dialog box, select **Universal Plug and Play** and click **OK**.

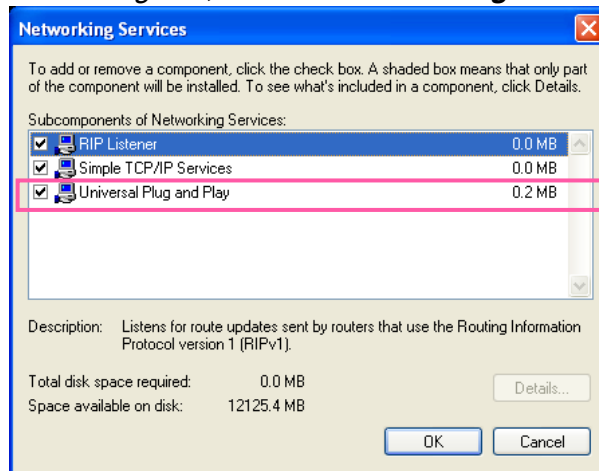

5. Click **Next** in the following window.

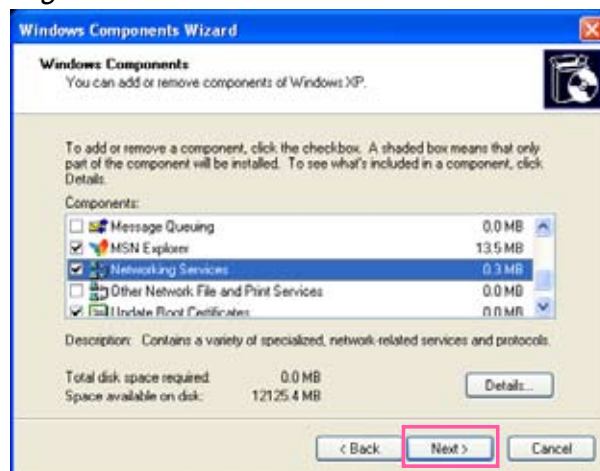

6. Click **Finish**. UPnP™ is enabled.

► **How does UPnP™ work?**

UPnP™ networking technology provides automatic IP configuration and dynamic discovery of devices added to a network. Services and capabilities offered by networked devices, such as printing and file sharing, are available among each other without the need for cumbersome network configuration. In the case of Network Cameras, you will see Network Camera shortcuts under My Network Places.

► **Enabling UPnP port forwarding allows the Network Camera to open a secondary HTTP port on the router-not HTTP port-meaning that you have to add the secondary HTTP port number to the Network Camera's public address in order to access the Network Camera from the Internet. For example, when the HTTP port is set to 80 and the secondary HTTP port is set to 8080, refer to the list below for the Network Camera's IP address.**

From the Internet	In LAN
http://203.67.124.123:8080	http://192.168.4.160 or http://192.168.4.160:8080

► **If the PPPoE settings are incorrectly configured or the Internet access is not working, restore the Network Camera to factory default; please refer to Restore on page 101 for details. After the Network Camera is reset to factory default, it will be accessible on the LAN.**

Enable IPv6

Select this option and click **Save** to enable IPv6 settings. Please note that this only works if your network environment and hardware equipment support IPv6. The browser should be Microsoft® Internet Explorer 6.5, Mozilla Firefox 3.0 or above.

Network Type

LAN:

- Get IP address automatically
- Use fixed IP address:
- Enable UPnP presentation
- Enable UPnP port forwarding

PPPoE:

- Enable IPv6

Manually setup the IP address

When IPv6 is enabled, by default, the network camera will listen to router advertisements and be assigned with a link-local IPv6 address accordingly.

IPv6 Information: Click this button to obtain the IPv6 information as shown below.

IPv6 NET Information

[eth0 address]

IPv6 address list of host

[Gateway]

IPv6 address list of gateway

[DNS]

IPv6 address list of DNS

If your IPv6 settings are successful, the IPv6 address list will be listed in the pop-up window. The IPv6 address will be displayed as follows:

Refers to Ethernet

	[eth0 address]	
	2001:0c08:2500:0002:0202:d1ff:fe04:65f4/64@Global	— Link-global IPv6 address/network mask
	fe80:0000:0000:0000:0202:d1ff:fe04:65f4/64@Link	— Link-local IPv6 address/network mask
	[Gateway]	
	fe80::211:d8ff:fea2:1a2b	
	[DNS]	
	2010:05c0:978d::	

Please follow the steps below to link to an IPv6 address:

1. Open your web browser.
2. Enter the link-global or link-local IPv6 address in the address bar of your web browser.
3. The format should be:

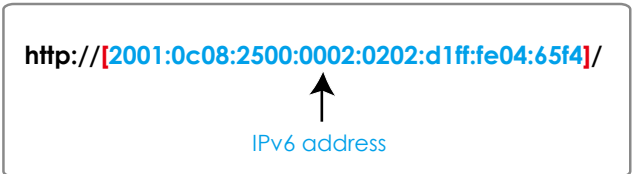

4. Press **Enter** on the keyboard or click **Refresh** button to refresh the webpage.
For example:

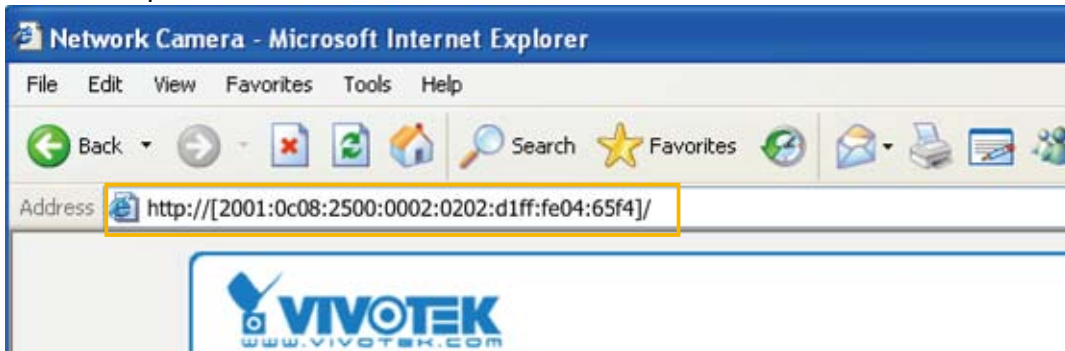

NOTE

- ▶ If you have a Secondary HTTP port (the default value is 8080), you can also link to the webpage in the following address format: (Please refer to **HTTP** on page 43 for detailed information.)



- ▶ If you choose PPPoE as the Network Type, the [PPPoE address] will be displayed in the IPv6 information column as shown below.

[eth0 address]	fe80:0000:0000:0000:0202:d1ff:fe11:2299/64@Link
[ppp0 address]	fe80:0000:0000:0000:0202:d1ff:fe11:2299/10@Link
	2001:b100:01c0:0002:0202:d1ff:fe11:2299/64@Global
[Gateway]	fe80::90:1a00:4142:8ced
[DNS]	2001:b000::1

Manually setup the IP address: Select this option to manually set up IPv6 settings if your network environment does not have DHCPv6 server and router advertisements-enabled routers.

If you check this item, the following blanks will be displayed for you to enter the corresponding information:

Enable IPv6

IPv6 Information

Manually setup the IP address

Optional IP address / Prefix length / 64

Optional default router

Optional primary DNS

IEEE 802.1x Advanced Mode

Enable this function if your network environment uses IEEE 802.1x, which is a port-based network access control. The network devices, intermediary switch/access point/hub, and RADIUS server must support and enable 802.1x settings.

The 802.1x standard is designed to enhance the security of local area networks, which provides authentication to network devices (clients) attached to a network port (wired or wireless). If all certificates between client and server are verified, a point-to-point connection will be enabled; if authentication fails, access on that port will be prohibited. 802.1x utilizes an existing protocol, the Extensible Authentication Protocol (EAP), to facilitate communication.

■ The components of a protected network with 802.1x authentication:



1. Supplicant: A client end user (camera), which requests authentication.
2. Authenticator (an access point or a switch): A “go between” which restricts unauthorized end users from communicating with the authentication server.
3. Authentication server (usually a RADIUS server): Checks the client certificate and decides whether to accept the end user’s access request.

■ VIVOTEK Network Cameras support two types of EAP methods to perform authentication: **EAP-PEAP** and **EAP-TLS**.

Please follow the steps below to enable 802.1x settings:

1. Before connecting the Network Camera to the protected network with 802.1x, please apply a digital certificate from a Certificate Authority (ie. MIS of your company) which can be validated by a RADIUS server.
2. Connect the Network Camera to a PC or notebook outside of the protected LAN. Open the configuration page of the Network Camera as shown below. Select **EAP-PEAP** or **EAP-TLS** as the EAP method. In the following blanks, enter your ID and password issued by the CA, then upload related certificate(s).

IEEE 802.1x

Enable 802.1x

EAP method: EAP-PEAP ▼

Identity:

Password:

CA certificate:

Status: no file

IEEE 802.1x

Enable 802.1x

EAP method: EAP-TLS ▾

Identity:

Private key password:

CA certificate: Browse... Upload

Status: no file Remove

client certificate: Browse... Upload

Status: no file Remove

Client private key: Browse... Upload

Status: no file Remove

3. When all settings are complete, move the Network Camera to the protected LAN by connecting it to an 802.1x enabled switch. The devices will then start the authentication automatically.

NOTE

► *The authentication process for 802.1x:*

1. *The Certificate Authority (CA) provides the required signed certificates to the Network Camera (the supplicant) and the RADIUS Server (the authentication server).*
2. *A Network Camera requests access to the protected LAN using 802.1X via a switch (the authenticator). The client offers its identity and client certificate, which is then forwarded by the switch to the RADIUS Server, which uses an algorithm to authenticate the Network Camera and returns an acceptance or rejection back to the switch.*
3. *The switch also forwards the RADIUS Server's certificate to the Network Camera.*
4. *Assuming all certificates are validated, the switch then changes the Network Camera's state to authorized and is allowed access to the protected network via a pre-configured port.*

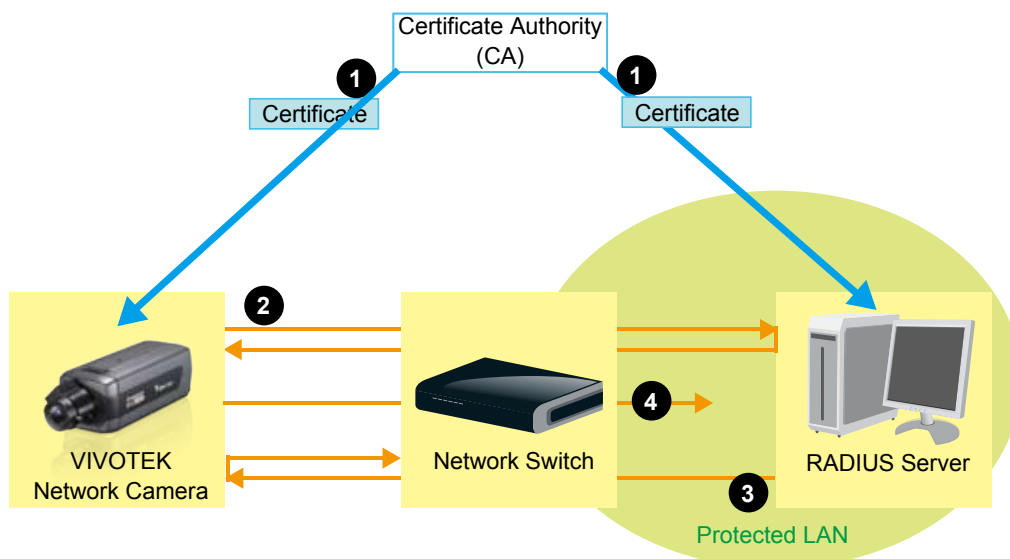

QoS (Quality of Service) Advanced Mode

Quality of Service refers to a resource reservation control mechanism, which guarantees a certain quality to different services on the network. Quality of service guarantees are important if the network capacity is insufficient, especially for real-time streaming multimedia applications. Quality can be defined as, for instance, a maintained level of bit rate, low latency, no packet dropping, etc.

The following are the main benefits of a QoS-aware network:

- The ability to prioritize traffic and guarantee a certain level of performance to the data flow.
- The ability to control the amount of bandwidth each application may use, and thus provide higher reliability and stability on the network.

Requirements for QoS

To utilize QoS in a network environment, the following requirements must be met:

- All network switches and routers in the network must include support for QoS.
- The network video devices used in the network must be QoS-enabled.

QoS models

CoS (the VLAN 802.1p model)

IEEE802.1p defines a QoS model at OSI Layer 2 (Data Link Layer), which is called CoS, Class of Service. It adds a 3-bit value to the VLAN MAC header, which indicates prioritization from 0~7 (Eight different classes of service are available). The priority is set up on the network switches, which then use different queuing disciplines to forward the packets.

Below is the setting column for CoS. Enter the **VLAN ID** of your switch (0~4095) and choose the priority for each application (0~7).

CoS

Enable CoS

VLAN ID:

Live video: ▼

Live audio: ▼

Event/Alarm: ▼

Management: ▼

If you assign Video the highest level, the switch will handle video packets first.

NOTE

- ▶ *The web browsing may fail if the CoS setting is incorrect.*
- ▶ *Class of Service technologies do not guarantee a level of service in terms of bandwidth and delivery time; they offer a "best-effort." Users can think of CoS as "coarsely-grained" traffic control and QoS as "finely-grained" traffic control.*
- ▶ *Though CoS is simple to manage, it lacks scalability and does not offer end-to-end quarantees since it is based on L2 protocol.*

QoS/DSCP (the DiffServ model)

DSCP-ECN defines QoS at Layer 3 (Network Layer). The Differentiated Services (DiffServ) model is based on packet marking and router queuing disciplines. The marking is done by adding a field to the IP header, called the DSCP (Differentiated Services Codepoint). This is a 6-bit field that provides 64 different class IDs. It gives an indication of how a given packet is to be forwarded, known as the Per Hop Behavior (PHB). The PHB describes a particular service level in terms of bandwidth, queueing theory, and dropping (discarding the packet) decisions. Routers at each network node classify packets according to their DSCP value and give them a particular forwarding treatment; for example, how much bandwidth to reserve for it.

Below are the setting options of DSCP (DiffServ Codepoint). Specify the DSCP value for each application (0~63).

QoS/DSCP

Enable QoS/DSCP

Live video:	<input type="text" value="0"/>
Live audio:	<input type="text" value="0"/>
Event/Alarm:	<input type="text" value="0"/>
Management:	<input type="text" value="0"/>

HTTP **Advanced Mode**

To utilize HTTP authentication, make sure that you have set a password for the Network Camera first; please refer to Security on page 26 for details.

HTTP

Authentication:

HTTP port:

Secondary HTTP port:

Access name for stream 1:

Access name for stream 2:

Access name for stream 3:

Access name for stream 4:

Access name for stream 5:

Authentication: Depending on your network security requirements, the Network Camera provides two types of security settings for an HTTP transaction: basic and digest.

If **basic** authentication is selected, the password is sent in plain text format and there can be potential risks of being intercepted. If **digest** authentication is selected, user credentials are encrypted using MD5 algorithm and thus provide better protection against unauthorized accesses.

HTTP port / Secondary HTTP port: By default, the HTTP port is set to 80 and the secondary HTTP port is set to 8080. They can also be assigned to another port number between 1025 and 65535. If the ports are incorrectly assigned, the following warning messages will be displayed:

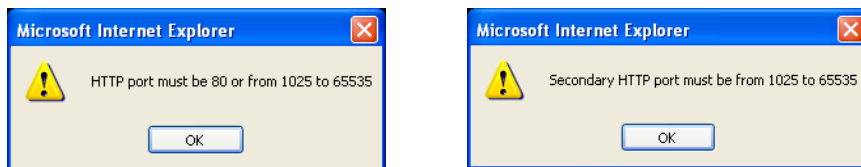

To access the Network Camera on the LAN, both the HTTP port and secondary HTTP port can be used to access the Network Camera. For example, when the HTTP port is set to 80 and the secondary HTTP port is set to 8080, refer to the list below for the Network Camera’s IP address.

```

In LAN
http://192.168.4.160 or
http://192.168.4.160:8080
    
```

Access name for stream 1 ~ 5: This Network camera supports multiple streams simultaneously. The access name is used to differentiate the streaming source. Users can click **Configuration > Audio and Video > Video Settings** to set up the video quality of linked streams. For more information about how to set up the video quality, please refer to Viewing Windows on page 59.

When using Mozilla Firefox or Netscape to access the Network Camera and the video mode is set to JPEG, users will receive video comprised of continuous JPEG images. This technology, known as “server push”, allows the Network Camera to feed live pictures to Mozilla Firefox and Netscape.

URL command -- <http://<ip address>:<http port>/<access name for stream 1 ~ 5>>

For example, when the Access name for stream 2 is set to [video2.mjpg](#):

1. Launch Mozilla Firefox or Netscape.
2. Type the above URL command in the address bar. Press **Enter**.
3. The JPEG images will be displayed in your web browser.

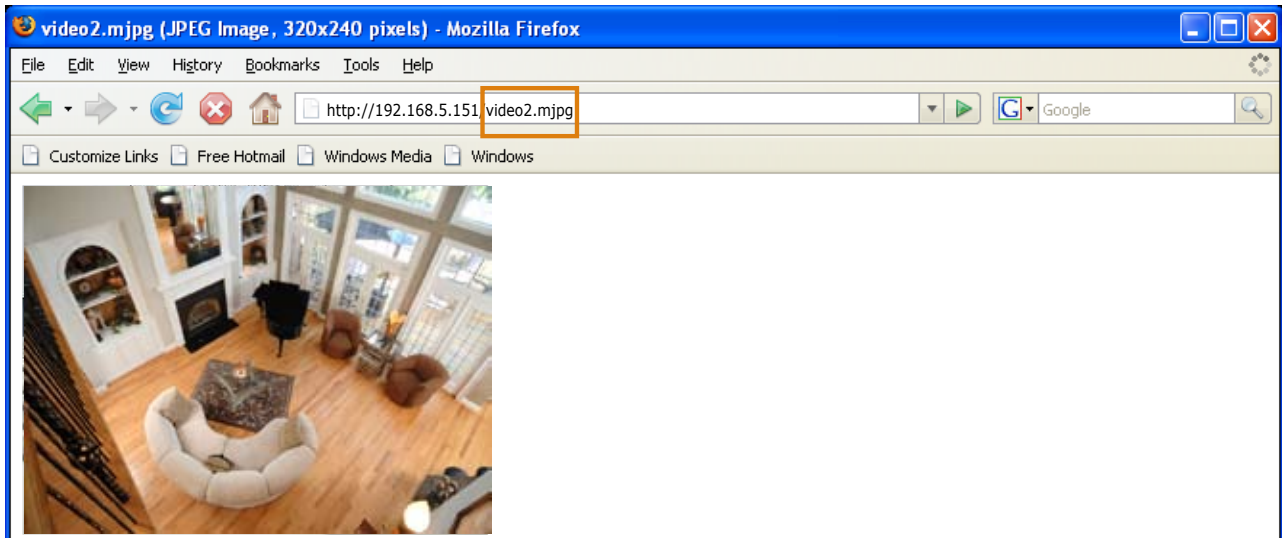

NOTE

- ▶ Microsoft® Internet Explorer does not support server push technology; therefore, using <http://<ip address>:<http port>/<access name for stream 1 ~ 5>> will fail to access the Network Camera.
- ▶ Users can only use URL commands to request the stream 5. For more information about URL commands, please refer to page 105.

HTTPS

HTTPS

HTTPS port:

By default, the HTTPS port is set to 443. It can also be assigned to another port number between 1025 and 65535.

Two way audio

Two way audio

Two way audio port:

By default, the two way audio port is set to 5060. Also, it can also be assigned to another port number between 1025 and 65535.

The Network Camera supports two way audio communication so that operators can transmit and receive audio simultaneously. By using the Network Camera's built-in or external microphone and an external speaker, you can communicate with people around the Network Camera.

Note that as JPEG only transmits a series of JPEG images to the client, to enable the two-way audio function, make sure the video mode is set to "MPEG-4" on the Audio and Video Settings page and the media option is set to "Video and Audio" on the Client Settings page. Please refer to Client Settings on page 21 and Audio and Video Settings on page 52.

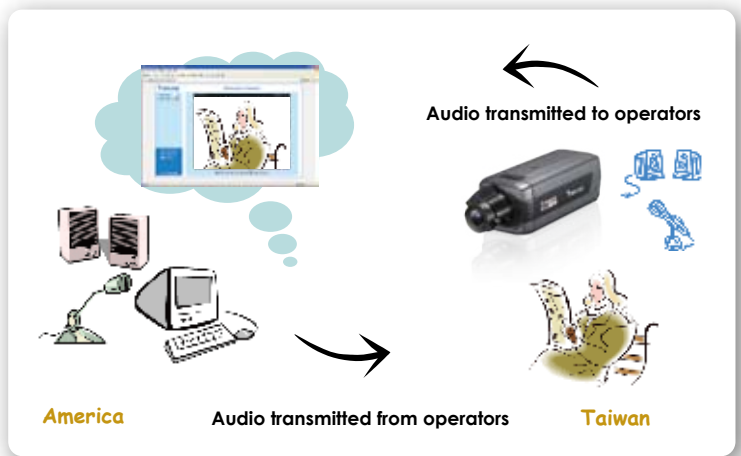

Audio is being transmitted to the Network Camera

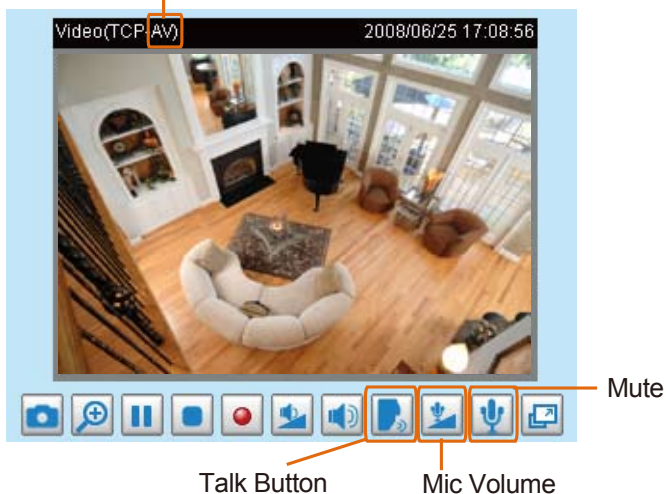

Click to enable audio transmission to the Network Camera; click to adjust the volume of microphone; click to turn off the audio. To stop talking, click again.

FTP

FTP

FTP port:

The FTP server allows the user to save recorded video clips. You can utilize VIVOTEK's Installation Wizard 2 to upgrade the firmware via FTP server. By default, the FTP port is set to 21. It also can be assigned to another port number between 1025 and 65535.

RTSP Streaming

To utilize RTSP streaming authentication, make sure that you have set a password for the Network Camera first; please refer to Security on page 26 for details.

RTSP Streaming

Authentication:

Access name for stream 1:

Access name for stream 2:

Access name for stream 3:

Access name for stream 4:

Access name for stream 5:

RTSP port:

RTP port for video:

RTCP port for video:

RTP port for audio:

RTCP port for audio:

Authentication: Depending on your network security requirements, the Network Camera provides three types of security settings for streaming via RTSP protocol: disable, basic, and digest.

If **basic** authentication is selected, the password is sent in plain text format, but there can be potential risks of it being intercepted. If **digest** authentication is selected, user credentials are encrypted using MD5 algorithm, thus providing better protection against unauthorized access.

The availability of the RTSP streaming for the three authentication modes is listed in the following table:

	Quick Time player	Real Player
Disable	O	O
Basic	O	O
Digest	O	X

Access name for stream 1 ~ 5: This Network camera supports multiple streams simultaneously. The access name is used to differentiate the streaming source.

If you want to use an **RTSP player** to access the Network Camera, you have to set the video mode to **MPEG-4** and use the following RTSP URL command to request transmission of the streaming data.

`rtsp://<ip address>:<rtsp port>/<access name for stream1 ~ 5>`

For example, when the access name for **stream 1** is set to **live.sdp**:

1. Launch an RTSP player.
2. Choose File > Open URL. A URL dialog box will pop up.
3. Type the above URL command in the text box.
4. The live video will be displayed in your player as shown below.

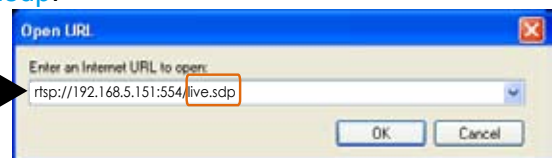

RTSP port /RTP port for video, audio/ RTCP port for video, audio

- RTSP (Real-Time Streaming Protocol) controls the delivery of streaming media. By default, the port number is set to 554.
- The RTP (Real-time Transport Protocol) is used to deliver video and audio data to the clients. By default, the RTP port for video is set to 5556 and the RTP port for audio is set to 5558.
- The RTCP (Real-time Transport Control Protocol) allows the Network Camera to transmit the data by monitoring the Internet traffic volume. By default, the RTCP port for video is set to 5557 and the RTCP port for audio is set to 5559.

The ports can be changed to values between 1025 and 65535. The RTP port must be an even number and the RTCP port is the RTP port number plus one, and thus is always an odd number. When the RTP port changes, the RTCP port will change accordingly.

If the RTP ports are incorrectly assigned, the following warning message will be displayed:

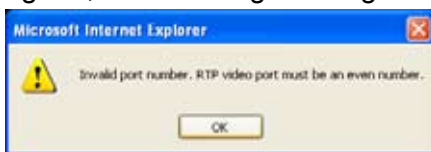

Multicast settings for stream 1 ~ 5: Click the items to display the detailed configuration information. Select the Always multicast option to enable multicast for stream 1 ~ 5.

▼ Multicast settings for stream 1:

Always multicast

Multicast group address: 239.128.1.99

Multicast video port: 5560

Multicast RTCP video port: 5561

Multicast audio port: 5562

Multicast RTCP audio port: 5563

Multicast TTL [1~255]: 15

▼ Multicast settings for stream 2:

Always multicast

Multicast group address: 239.128.1.100

Multicast video port: 5564

Multicast RTCP video port: 5565

Multicast audio port: 5566

Multicast RTCP audio port: 5567

Multicast TTL [1~255]: 15

Unicast video transmission delivers a stream through point-to-point transmission; multicast, on the other hand, sends a stream to the multicast group address and allows multiple clients to acquire the stream at the same time by requesting a copy from the multicast group address. Therefore, enabling multicast can effectively save Internet bandwidth.

The ports can be changed to values between 1025 and 65535. The multicast RTP port must be an even number and the multicast RTCP port number is the multicast RTP port number plus one, and thus is always odd. When the multicast RTP port changes, the multicast RTCP port will change accordingly.

If the multicast RTP video ports are incorrectly assigned, the following warning message will be displayed:



Multicast TTL [1~255]: The multicast TTL (Time To Live) is the value that tells the router the range a packet can be forwarded.

DDNS

This section explains how to configure the dynamic domain name service for the Network Camera. DDNS is a service that allows your Network Camera, especially when assigned with a dynamic IP address, to have a fixed host and domain name.

DDNS: Dynamic domain name service

Enable DDNS: Select this option to enable the DDNS setting.

Provider: Select a DDNS provider from the provider drop-down list.

VIVOTEK offers [Safe100.net](#), a free dynamic domain name service, to VIVOTEK customers. It is recommended that you register [Safe100.net](#) to access VIVOTEK's Network Cameras from the Internet. Additionally, we offer other DDNS providers, such as Dyndns.org(Dynamic), Dyndns.org(Custom), TZO.com, DHS.org, CustomSafe100, dyn-interfree.it.

Note that before utilizing this function, please apply for a dynamic domain account first.

■ [Safe100.net](#)

1. In the DDNS column, select [Safe100.net](#) from the drop-down list. Click **I accept** after reviewing the terms of the Service Agreement.
2. In the Register column, fill in the Host name (xxxx.safe100.net), Email, Key, and Confirm Key, and click **Register**. After a host name has been successfully created, a success message will be displayed in the DDNS Registration Result column.

3. Click **Copy** and all the registered information will automatically be uploaded to the corresponding fields in the DDNS column at the top of the page as seen in the picture.

DDNS: Dynamic domain name service

Enable DDNS:

Provider:

Host name: [*.safe100.net]

Email:

Key:

Register

Host name:

Email:

Key:

Confirm key:

To apply for a domain name for the camera, or to modify the previously registered information, fill in the following fields and then click "Register".

DDNS Registration Result:

Upon successful registration, you can click [copy](#) to automatically upload relevant information to the DDNS form or you can manually fill it in. Then, click "Save" to save new settings.

4. Select Enable DDNS and click **Save** to enable the setting.

■ CustomSafe100

VIVOTEK offers documents to establish a CustomSafe100 DDNS server for distributors and system integrators. You can use CustomSafe100 to register a dynamic domain name if your distributor or system integrators offer such services.

1. In the DDNS column, select CustomSafe100 from the drop-down list.
2. In the Register column, fill in the Host name, Email, Key, and Confirm Key; then click **Register**. After a host name has been successfully created, you will see a success message in the DDNS Registration Result column.
3. Click **Copy** and all for the registered information will be uploaded to the corresponding fields in the DDNS column.
4. Select Enable DDNS and click **Save** to enable the setting.

Forget key: Click this button if you have forgotten the key to Safe100.net or CustomSafe100. Your account information will be sent to your email address.

Refer to the following links to apply for a dynamic domain account when selecting other DDNS providers:

- [Dyndns.org\(Dynamic\) / Dyndns.org\(Custom\)](http://www.dyndns.com/): visit <http://www.dyndns.com/>
- [TZO.com](http://www.tzo.com/): visit <http://www.tzo.com/>
- [DHS.org](http://www.dns.org/): visit <http://www.dns.org/>
- dyn-interfree.it: visit <http://dyn-interfree.it/>

Access List Advanced Mode

This section explains how to control access permission by verifying the client PC's IP address.

General Settings

General Settings

Maximum number of concurrent streaming connection(s) limited to:

Enable access list filtering

Maximum number of concurrent streaming connection(s) limited to: Simultaneous live viewing for 1~10 clients (including stream 1 and stream 2). The default value is 10. If you modify the value and click **Save**, all current connections will be disconnected and automatically attempt to re-link (IE Explore or Quick Time Player).

View Information: Click this button to display the connection status window showing a list of the current connections. For example:

Connection status

	IP address	Elapsed time	User ID
<input type="checkbox"/>	192.168.1.147	12:20:34	root
<input type="checkbox"/>	61.22.15.3	00:10:09	
<input type="checkbox"/>	192.168.3.25	45:00:34	greg

- IP address: Current connections to the Network Camera.
- Elapsed time: How much time the client has been at the webpage.
- User ID: If the administrator has set a password for the webpage, the clients have to enter a user name and password to access the live video. The user name will be displayed in the User ID column. If the administrator allows clients to link to the webpage without a user name and password, the User ID column will be empty.

There are some situations which allow clients access to the live video without a user name and password:

1. The administrator does not set up a root password. For more information about how to set up a root password and manage user accounts, please refer to Security on page 26.
2. The administrator has set up a root password, but set **RTSP Authentication** to "disable". For more information about **RTSP Authentication**, please refer to RTSP Streaming on page 46.
3. The administrator has set up a root password, but allows anonymous viewing. For more information about **Allow Anonymous Viewing**, please refer to Security on page 26.

- Refresh: Click this button to refresh all current connections.
- Add to deny list: You can select entries from the Connection Status list and add them to the Deny List to deny access. Please note that those checked connections will only be disconnected temporarily and will automatically try to re-link again (IE Explore or Quick Time Player). If you want to enable the denied list, please check **Enable access list filtering** and click **Save** in the first column.
- Disconnect: If you want to break off the current connections, please select them and click this button. Please note that those checked connections will only be disconnected temporarily and will automatically try to re-link again (IE Explore or Quick Time Player).

Enable access list filtering: Check this item and click **Save** if you want to enable the access list filtering function.

Filter

There are two lists for permission control: Allowed list and Denied list. Only those clients whose IP addresses are on the Allowed list and not on the Denied list can access the Network Camera. Please note that the IPv6 access list column will not be displayed unless you enable IPv6 on the Network page. For more information about **IPv6 Settings**, please refer to page 37 for detailed information.

General Settings

Maximum number of concurrent streaming connection(s) limited to: 10 View Information

Enable access list filtering

Save

Filter

IPv4 access list

<p>Allowed list</p> <div style="border: 1px solid #ccc; padding: 5px; min-height: 40px;">1.0.0.0-255.255.255.255</div> <p style="text-align: center;">Add Delete</p>	<p>Denied list</p> <div style="border: 1px solid #ccc; padding: 5px; min-height: 40px;"></div> <p style="text-align: center;">Add Delete</p>
---	---

IPv6 access list

<p>Allowed list</p> <div style="border: 1px solid #ccc; padding: 5px; min-height: 40px;">::/0</div> <p style="text-align: center;">Add Delete</p>	<p>Denied list</p> <div style="border: 1px solid #ccc; padding: 5px; min-height: 40px;"></div> <p style="text-align: center;">Add Delete</p>
--	---

- Add a rule to Allowed/Denied list: Click **Add** to add a rule to Allowed/Denied list.

There are three types of rules:

Single: This rule allows the user to add an IP address to the Allowed/Denied list.

For example:

filter address

Rule: Single

IP address: 192.168.2.1

OK Cancel

Network: This rule allows the user to assign a network address and corresponding subnet mask to the Allow/Deny List.
 For example:

filter address

Rule: Network ▾

Network address / Network mask /

IP address 192.168.2.x will be blocked.

Range: This rule allows the user to assign a range of IP addresses to the Allow/Deny List. This rule is only applied to IPv4.
 For example:

filter address

Rule: Range ▾

IP address - IP address -

■ **Delete Allowed/Denied list:**

In the Delete Allowed List or Delete Denied List column, make a selection and click **Delete**.

NOTE

► For example, when the range of IP addresses on the allowed list is set from 1.1.1.0 to 192.255.255.255 and the range in the denied list is set from 1.1.1.0 to 170.255.255.255, only users' IPs between 171.0.0.0 and 192.255.255.255 can access the Network Camera.

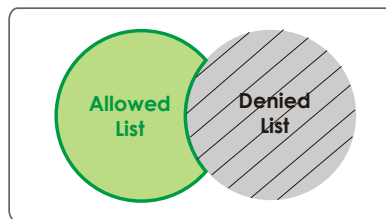

Administrator IP address

Always allow the IP address to access this device: You can check this item and add the Administrator's IP address in this field to make sure the Administrator can always connect to the device.

Administrator IP address

Always allow the IP address to access this device

Audio and Video

This section explains how to configure the audio and video settings of the Network Camera. It is composed of the following two columns: Video Settings and Audio Settings.

Video Settings

Video settings

Video title:

Color: Color ▾

Power line frequency: 60 Hz ▾

Select caching stream: Stream 1 ▾

Video orientation: Flip Mirror

Overlay title and time stamp on video and snapshot.

Enable time shift caching stream

Image Settings Privacy Mask Sensor Settings Viewing Window

Video title: Enter a name that will be displayed on the title bar of the live video.

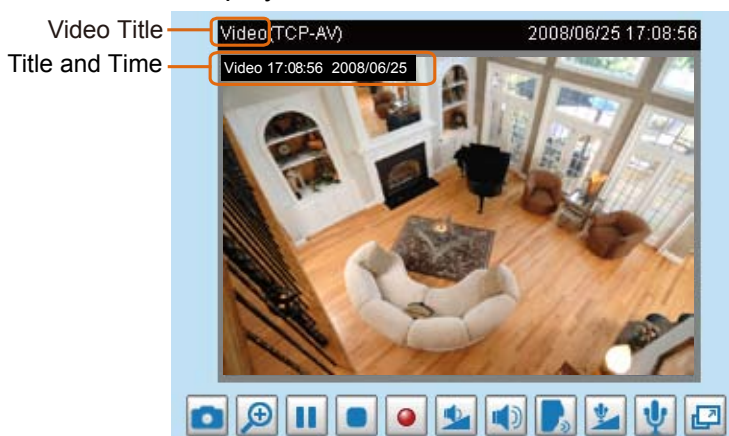

Color: Select to display color or black/white video streams.

Power line frequency: Set the power line frequency consistent with local utility settings to eliminate image flickering associated with fluorescent lights. Note that after the power line frequency is changed, you must disconnect and reconnect the power cord of the Network Camera in order for the new setting to take effect.

Select caching stream: This Network Camera supports time shift cache stream on the Network Camera. Select one stream and check the below option **Enable time shift caching stream**.

Enable time shift caching stream Advanced Mode: Check this item to enable the time shift cache stream on the Network Camera, which will stores video in the camera's embedded memory for a period of time depending on the cache memory of each Network Camera. This function can work seamlessly with VIVOTEK's ST7501 recording software. When an event occurs, the recording software can request time shift cache stream from the camera, which allows the user to get an earlier video data.

Video orientation: Flip--vertically reflect the display of the live video; Mirror--horizontally reflect the display of the live video. Select both options if the Network Camera is installed upside-down (ex. on the ceiling) to correct the image orientation.

Overlay title and time stamp on video: Select this option to place the video title and time on the video streams.

Note that when the frame size is set to 176 x 144 as shown in the picture below, only the time will be stamped on the video streams.

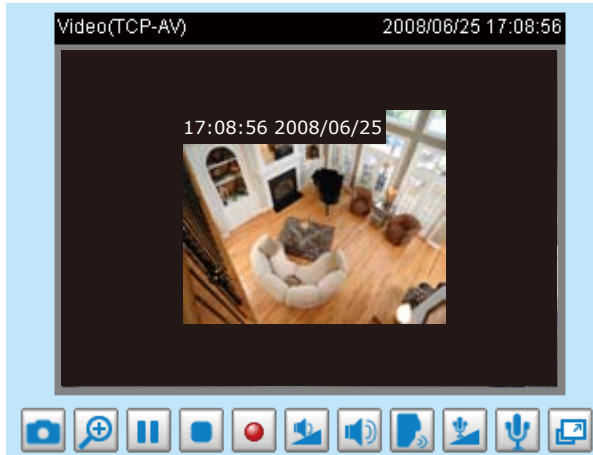

[Image Settings](#) **Advanced Mode**

Click **Image settings** to open the Image Settings page. On this page, you can tune the White balance, Brightness, Saturation, Contrast, and Sharpness settings for the video.

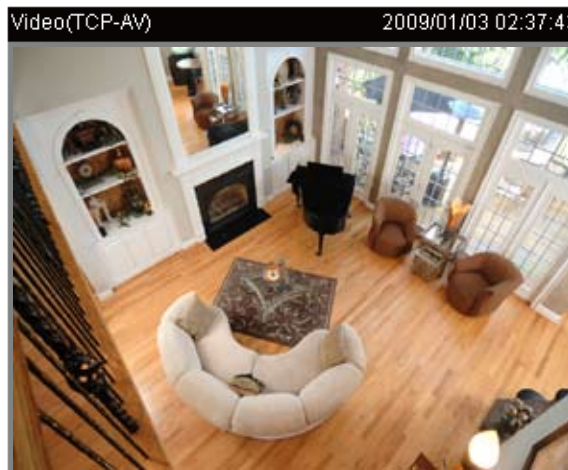

White Balance

Auto Save

Image Adjustment

Brightness: -5 Saturation: +0

Contrast: +0 Sharpness: +0

Enable Edge Enhancement

Enable Noise Reduction

Preview Restore Save

Close

White balance: Adjust the value for the best color temperature.

■ Auto

The Network Camera automatically adjusts the color temperature of the light in response to different light sources. The white balance setting defaults to **Auto** and works well in most situations.

■ Keep current value

Follow the steps below to manually set the white balance to compensate for the ambient lighting conditions.

1. Set the White balance to **Auto** and click **Save**.
2. Place a sheet of white paper in front of the lens, then allow the Network Camera to adjust the color temperature automatically.
3. Select Keep Current Value to confirm the setting while the white balance is being measured.
4. Click **Save** to enable the new setting.

Image Adjustment

- **Brightness**: Adjust the image brightness level, which ranges from -5 to +5. The default value is set to -5.
- **Saturation**: Adjust the image saturation level, which ranges from -5 to +5. The default value is set to 0.
- **Contrast**: Adjust the image contrast level, which ranges from -5 to +5. The default value is set to 0.
- **Sharpness**: Adjust the image sharpness level, which ranges from -5 to +5. The default value is set to 0.

Enable Edge Enhancement

Edge enhancement is an image processing filter that enhances the edge contrast of an image or video to improve its sharpness. Enter a value from 1 to 128 to set the degree of enhancement desired.

Enable Edge Enhancement

Strength: (1~128)

Enable Noise Reduction

Noise reduction is the process of removing noise from a signal. Select the type of noise to remove and enter a value from 1 to 63 to set the degree of enhancement required.

Enable Noise Reduction

Remove Noise: ▼

Strength: (1~63)

You can click **Preview** to fine-tune the image, or click **Restore** to recall the original settings without incorporating the changes. When completed with the settings on this page, click **Save** to enable the setting and click **Close** to exit the page.

Privacy Mask **Advanced Mode**

Click **Privacy Mask** to open the settings page. On this page, you can block out sensitive zones to address privacy concerns.



■ To set the privacy mask windows, follow the steps below:

1. Click **New** to add a new window.
2. Use the mouse to size and drag-drop the window, which is recommended to be at least twice the size of the object (height and width) you want to cover.
3. Enter a Window Name and click **Save** to enable the setting.
4. Select **Enable privacy mask** to enable this function.

NOTE

- ▶ *Up to 5 privacy mask windows can be set up on the same screen.*
- ▶ *If you want to delete the privacy mask window, please click the 'x' on the upper right-hand corner of the window.*

[Sensor Settings](#) **Advanced Mode**

Click **Sensor Settings** to open the Sensor Settings page. On this page, you can set the maximum exposure time, exposure level, and AGC (Auto Gain Control) settings.

You can configure two sets of sensor settings: one for normal situations, the other for special situations, such as day/night/schedule mode.



Exposure

Maximum Exposure Time:		1/30 S ▾	Sensor Setting 1: For normal situations
Exposure level:		4 ▾	
Enable AGC:		4X ▾	
<input type="checkbox"/> Enable BLC			Sensor Setting 2: For special situations
<input type="button" value="Profile"/>			

Exposure

- **Maximum Exposure Time:** Select a proper maximum exposure time according to the light source of the surroundings. The exposure times are selectable for the following durations: 1/120 second, 1/90 second, 1/30 second, 1/15 second, and 1/5 second. Shorter exposure times result in less light.
- **Exposure level:** You can manually set the Exposure level, which ranges from 1 to 8 (dark to bright). The default value is 4.
- **Enable AGC (Auto Gain Control):** You can manually set the AGC level (2X 4X, or 8X). The default value is 4X.
- **Enable BLC (Back Light Compensation):** Enable this option when the object is too dark or too bright to recognize. It allows the camera to adjust to the best light conditions in any environment and automatically give the necessary light compensation.

You can click **Preview** to fine-tune the image, or click **Restore** to recall the original settings without incorporating the changes. When completed with the settings on this page, click **Save** to enable the settings and click **Close** to exit the page.

If you want to configure another sensor setting for day/night/schedule mode, please click **Profile** to open the Sensor Settings Profile Settings page as shown below.



General Settings

Enable this profile

This profile is applied to

Day mode

Night mode

Schedule mode:

Exposure

Maximum Exposure Time: 1/5 S ▼

Exposure level: 4 ▼

Enable AGC: 8X ▼

Enable BLC

Please follow the steps below to setup a profile:

1. Check **Enable this profile**.
2. Select the applied mode: Day mode, Night mode, or schedule mode. Please manually enter a range of time if you choose Schedule mode.
3. Configure Exposure settings in the second column. Please refer to last page for detailed information.
4. Click **Save** to enable the setting and click **Close** to exit the page.

Viewing Window **Advanced Mode**

This Network Camera supports multiple streams with frame size ranging from 176 x 144 to 1600 x 1200.



Options of Video

- Video quality first (MAX 15fps)
- Video frame rate first (Maximum frame size 800x600)

- ❖ Video quality settings for stream 1:
- ❖ Video quality settings for stream 2:
- ❖ Video quality settings for stream 3:
- ❖ Video quality settings for stream 4:

The definition of multiple streams:

- Stream 1: Users can define the "Region of Interest" (viewing region) and the "Output Frame Rate" (size of the live view window).
- Stream 2: Users can define the "Region of Interest" (viewing region) and the "Output Frame Rate" (size of the live view window).
- Stream 3 (Mobile stream): Users can define the "Region of Interest" (viewing region), but the "Output Frame Rate" (size of the live view window) is fixed at 176 x 144.
- Stream 4 (Global view stream): This stream captures the full view of the video and streams out at the maximum resolution (1600 x 1200).

Region of Interest (Viewing Region)

Output Frame Size (Size of the Live View Window)

Click **Viewing Window** to open the viewing region settings page. On this page, you can set the **Region of Interest** and the **Output Frame Size** for stream 1 ~ 3.

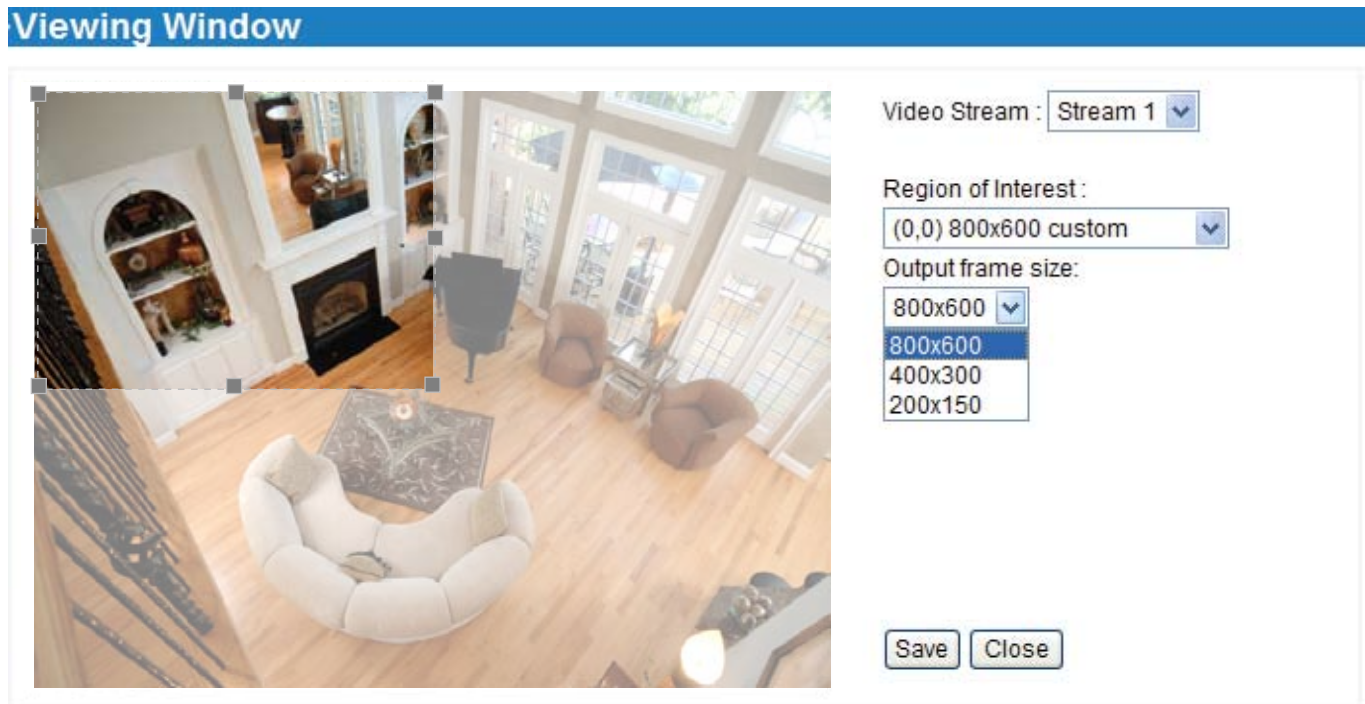

Please follow the steps below to set up those settings for a stream:

1. Select a stream which you want to set up the viewing region. If you want to stream out the video to a mobile device, please select stream 3.
2. Select a **Region of Interest** from the drop-down list. The floating frame, the same as the one in the Gloabl View window on the home page, will resize accordingly. If you want to set up a customized viewing region, you can also resize and drag the floating frame to a desired position with your mouse.
3. Choose a proper **Output Frame Size** from the drop-down list according to the size of your monitoring device.

■ The parameters of the multiple streams:

	Region of Interest	Output frame size
Stream 1	1600 X 1200 ~ 176 x 144 (Selectable)	1600 X 1200 ~ 176 x 144 (Selectable)
Stream 2	1600 X 1200 ~ 176 x 144 (Selectable)	1600 X 1200 ~ 176 x 144 (Selectable)
Stream 3	1468 x 1200 ~ 176 x 144 (Selectable)	176 x 144 (Fixed)
Stream 4	1600 X 1200 (Fixed)	1600 X 1200 (Fixed)

■ The maximum **Region of Interest** of stream 3 is 1468 x 1200. You can also check the item "Set region to full view" to extend the region to full view (1600 x 1200). However, the image will be distorted a little bit.

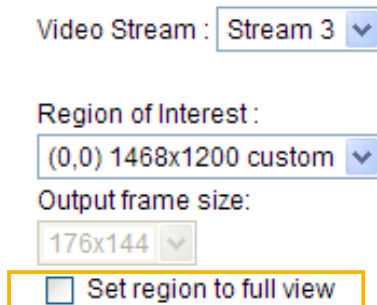

When completed with the settings in the Viewing Window, click **Save** to enable the settings and click **Close** to exit the window. The selected **Output Frame Size** will immediately be applied to the **Frame size** of each video stream as shown on the next page. Then you can go back to the home page to test the e-PTZ function. For more information about the e-PTZ function, please refer to page 74.

[Options of Video](#)

Choose either **Video quality first** or **Video frame rate first** for the video streams.

Note: Select Video quality first will reduce the maximum frame rate to 15 fps. Select Video frame rate first will limit the frame size to 800x600 and clear the settings in the Viewing Window.

Options of Video

- Video quality first (MAX 15fps)
- Video frame rate first (Maximum frame size 800x600)

[Video quality settings for stream 1 ~ 4](#) **Advanced Mode**

Click the items to display the detailed video quality settings.

The selections of frame sizes will be listed according to your settings in the Viewing Window.

Video quality settings for stream 1:

selectable

MPEG-4:

Frame size: 800x600

Maximum frame rate: 15 fps

Intra frame period: 1 S

Video quality:

Constant bit rate: 512 Kbps

Fixed quality: Good

JPEG:

Video quality settings for stream 3:

fixed

MPEG-4:

Frame size: 176x144

Maximum frame rate: 5 fps

Intra frame period: 1 S

Video quality:

Constant bit rate: 40 Kbps

Fixed quality: Good

JPEG:

Video quality settings for stream 2:

selectable

MPEG-4:

JPEG:

Frame size: 320x240

Maximum frame rate: 15 fps

Video quality: Good

Video quality settings for stream 4:

fixed

MPEG-4:

Frame size: 1600x1200

Maximum frame rate: 15 fps

Intra frame period: 1 S

Video quality:

Constant bit rate: 512 Kbps

Fixed quality: Good

JPEG:

This Network Camera offers two choices of video compression standards (MPEG-4 and MJPEG) for real-time viewing.

If **MPEG-4** mode is selected, the video is streamed via RTSP protocol. There are four parameters provided in MPEG-4 mode which allow you to adjust the video performance:

MPEG-4:

Frame size: 1600x1200

Maximum frame rate: 15 fps

Intra frame period: 1 S

Video quality:

Constant bit rate: 512 Kbps

Fixed quality: Good

- **Frame size**

You can set up different video resolution for different viewing devices. For example, set a smaller frame size and lower bit rate for remote viewing on mobile phones and a larger video size and a higher bit rate for live viewing on web browsers. Note that a larger frame size takes up more bandwidth.

- **Maximum frame rate**

This limits the maximum refresh frame rate per second. Set the frame rate higher for smoother video quality.

If the power line frequency is set to 50Hz, the frame rates are selectable at 1fps, 2fps, 3fps, 5fps, 8fps, 10fps, 15fps, 20fps, and 25fps. If the power line frequency is set to 60Hz, the frame rates are selectable at 1fps, 2fps, 3fps, 5fps, 8fps, 10fps, 15fps, 20fps, 25fps, and 30fps. You can also select **Customize** and manually enter a value. The frame rate will decrease if you select a higher resolution.

- **Intra frame period**

Determine how often to plant an I frame. The shorter the duration, the more likely you will get better video quality, but at the cost of higher network bandwidth consumption. Select the intra frame period from the following durations: 1/4 second, 1/2 second, 1 second, 2 seconds, 3 seconds, and 4 seconds.

- **Video quality**

A complex scene generally produces a larger file size, meaning that higher bandwidth will be needed for data transmission. Therefore, if **Constant bit rate** is selected, the bandwidth utilization is fixed at a selected level, resulting in mutable video quality performance. The bit rates are selectable at the following rates: 20Kbps, 30Kbps, 40Kbps, 50Kbps, 64Kbps, 128Kbps, 256Kbps, 512Kbps, 768Kbps, 1Mbps, 2Mbps, 3Mbps, and 4Mbps. You can also select **Customize** and manually enter a value.

On the other hand, if **Fixed quality** is selected, all frames are transmitted with the same quality; bandwidth utilization is therefore unpredictable. The video quality can be adjusted to the following settings: Medium, Standard, Good, Detailed, and Excellent. You can also select **Customize** and manually enter a value.

If **JPEG** mode is selected, the Network Camera continuously sends JPEG images to the client, producing a moving effect similar to a filmstrip. Every single JPEG image transmitted guarantees the same image quality, which in turn comes at the expense of variable bandwidth usage. Because the media contents are a combination of JPEG images, no audio data is transmitted to the client. There are three parameters provided in MJPEG mode to control the video performance:

JPEG:

Frame size:	1600x1200
Maximum frame rate:	15 fps
Video quality:	Good

- **Frame size**

You can set up different video resolution for different viewing devices. For example, set a smaller frame size and lower bit rate for remote viewing on mobile phones and a larger video size and a higher bit rate for live viewing on web browsers. Note that a larger frame size takes up more bandwidth.

- **Maximum frame rate**

This limits the maximum refresh frame rate per second. Set the frame rate higher for smoother video quality.

If the power line frequency is set to 50Hz, the frame rates are selectable at 1fps, 2fps, 3fps, 5fps, 8fps, 10fps, 15fps, 20fps, and 25fps. If the power line frequency is set to 60Hz, the frame rates are selectable at 1fps, 2fps, 3fps, 5fps, 8fps, 10fps, 15fps, 20fps, 25fps, and 30fps. You can also select **Customize** and manually enter a value. The frame rate will decrease if you select a higher resolution.

■ Video quality

The video quality can be adjusted to the following settings: Medium, Standard, Good, Detailed, and Excellent. You can also select **Customize** and manually enter a value.

NOTE

- ▶ *Video quality and fixed quality refers to the **compression rate**, so a lower value will produce higher quality.*

Day/Night Settings

▼ Day/Night settings:

Switch to B/W in night mode

IR cut filter:

Auto mode ▼

Light sensor sensitivity:

Normal ▼

Switch to B/W in night mode

Select this to enable the Network Camera to automatically switch to B/W during night mode.

IR cut filter

With a removable IR-cut filter, this Network Camera can automatically remove the filter to let IR light into the sensor during low light conditions.

■ Auto mode

The Network Camera automatically removes the filter by judging the level of ambient light.

■ Day mode

In day mode, the Network Camera switches on the IR cut filter at all times to block infrared light from reaching the sensor so that the colors will not be distorted.

■ Night mode

In night mode, the Network Camera switches off the IR cut filter at all times for the sensor to accept infrared light, thus helping to improve low light sensitivity.

■ Schedule mode

The Network Camera switches between day mode and night mode based on a specified schedule. Enter the start and end time for day mode. Note that the time format is [hh:mm] and is expressed in 24-hour clock time. By default, the start and end time of day mode are set to 07:00 and 18:00.

Light sensor sensitivity

Select Low, Normal, or High sensitivity for the light sensor.

Audio Settings

Audio Settings

Mute

Internal microphone input gain: 0 dB ▼

External microphone input: 0 dB ▼

Audio type:

AAC:

GSM-AMR:

GSM-AMR bit rate: 12.2 Kbps ▼

Mute: Select this option to disable audio transmission from the Network Camera to all clients. Note that if mute mode is turned on, no audio data will be transmitted even if audio transmission is enabled on the Client Settings page. In that case, the following message is displayed:

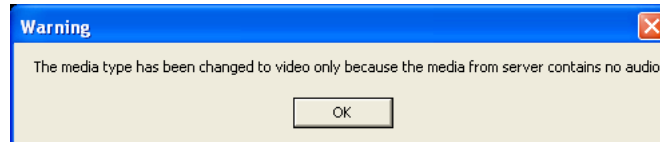

Internal microphone input gain: Select the gain of the internal audio input according to ambient conditions. Adjust the gain from +21 db (most sensitive) ~ -33 db (least sensitive).

External microphone input: Select the gain of the external audio input according to ambient conditions. Adjust the gain from +21 db (most sensitive) or -33 db (least sensitive).

Audio type: Select audio codec AAC or GSM-AMR and the bit rate **Advanced Mode**.

- AAC provides good sound quality at the cost of higher bandwidth consumption. The bit rates are selectable from: 16Kbps, 32Kbps, 48Kbps, 64Kbps, 96Kbps, and 128Kbps.
- GSM-ARM is designed to optimize speech quality and requires less bandwidth. The bit rates are selectable from: 4.75Kbps, 5.15Kbps, 5.90Kbps, 6.7Kbps, 7.4Kbps, 7.95Kbps, 10.2Kbps, and 12.2Kbps.

When completed with the settings on this page, click **Save** to enable the settings.

NOTE

- ▶ *The Network Camera offers two inputs to capture audio - internal microphone or external microphone. The internal/external microphone switch is located on the back panel of the Network Camera.*

Motion Detection

This section explains how to configure the Network Camera to enable motion detection. A total of three motion detection windows can be configured.



Motion Detection Setting 1:
For normal situations

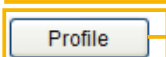

Motion Detection Setting 2:
For special situations

Follow the steps below to enable motion detection:

1. Click **New** to add a new motion detection window.
2. In the Window Name text box, enter a name for the motion detection window.
 - To move and resize the window, drag and drop your mouse on the window.
 - To delete window, click X on the top right corner of the window.
3. Define the sensitivity to moving objects and the space ratio of all alerted pixels by moving the Sensitivity and Percentage slider bar.
4. Click **Save** to enable the settings.
5. Select **Enable motion detection** to enable this function.

For example:

Enable motion detection

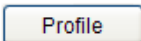

The Percentage Indicator will rise or fall depending on the variation between sequential images. When motions are detected by the Network Camera and are judged to exceed the defined threshold, the red bar rises. Meanwhile, the motion detection window will be outlined in red. Photos or videos can be captured instantly and configured to be sent to a remote server (Email, FTP) by utilizing this feature as a trigger source. For more information on how to set an event, please refer to Application on page 79.

A green bar indicates that even though motions have been detected, the event has not been triggered because the image variations still fall under the defined threshold.

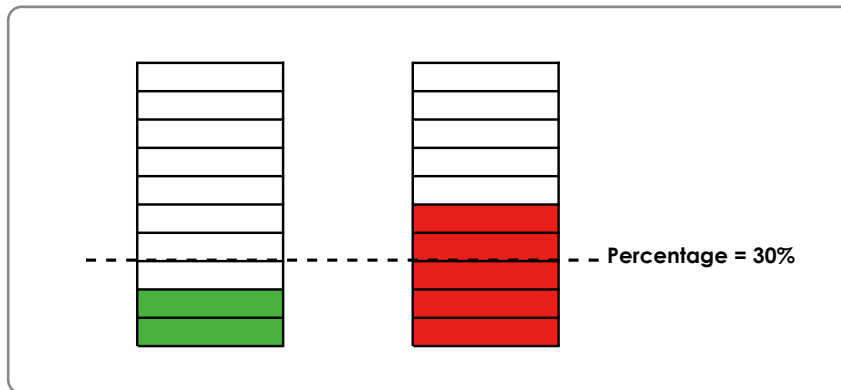

If you want to configure other motion detection settings for day/night/schedule mode, please click **Profile** to open the Motion Detection Profile Settings page as shown below. A total of three motion detection windows can be configured on this page as well.

The screenshot shows the Motion Detection Profile Settings page. At the top, there is a video feed of a living room with a timestamp of "2008/01/09 14:59:09". Below the video, there are settings for "Window Name", "Sensitivity", and "Percentage", each with a slider set to 0%. There are "New" and "Save" buttons. The bottom section is titled "General Settings" and includes a checkbox for "Enable this profile", radio buttons for "Day mode", "Night mode" (selected), and "Schedule mode", and a "Save" button. A "Close" button is located at the bottom center of the page.

Please follow the steps below to set up a profile:

1. Create a new motion detection window.
2. Check **Enable this profile**.
3. Select the applicable mode: Day mode, Night mode, or Schedule mode. Please manually enter a time range if you choose Schedule mode.
4. Click **Save** to enable the settings and click **Close** to exit the page.

This motion detection window will also be displayed on the Event Settings page. You can go to Application > Event Settings > Trigger to choose it as a trigger source. Please refer to page 81 for detailed information.

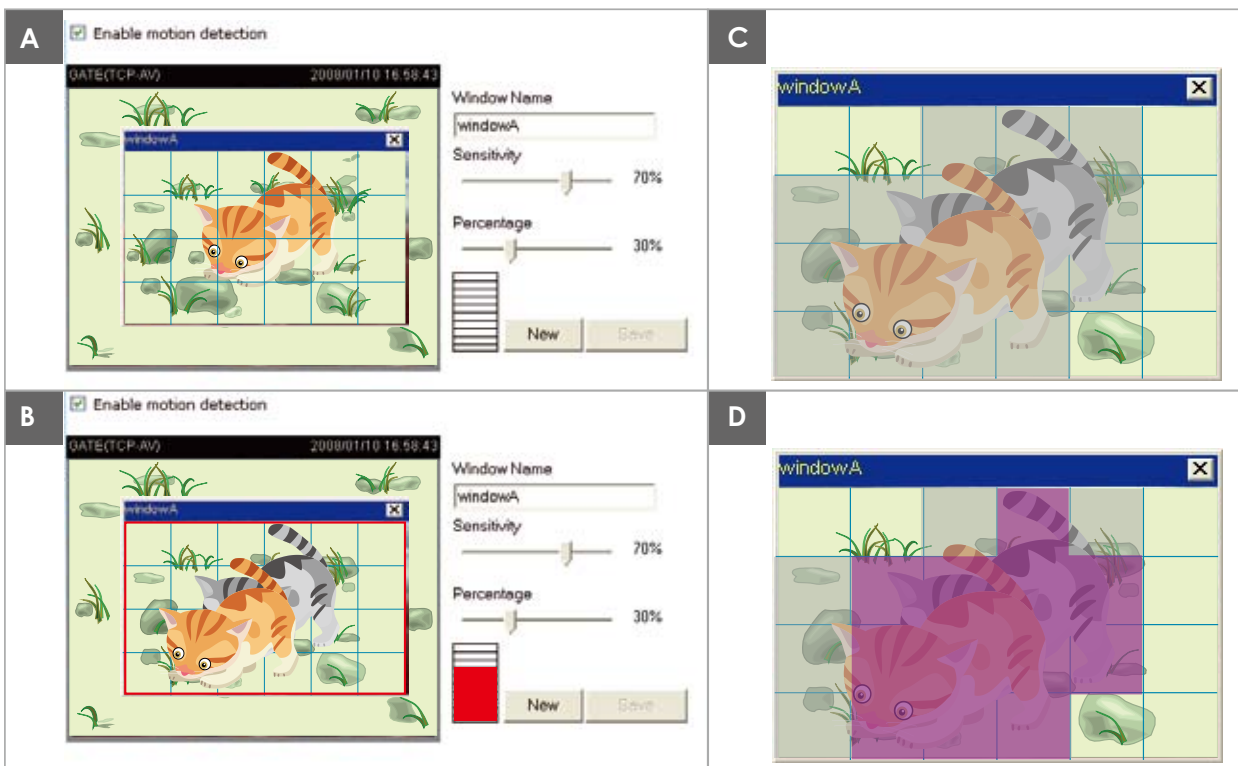
NOTE► *How does motion detection work?*

There are two motion detection parameters: *Sensitivity* and *Percentage*. In the illustration above, frame A and frame B are two sequential images. Pixel differences between the two frames are detected and highlighted in gray (frame C) and will be compared with the sensitivity setting. *Sensitivity* is a value that expresses the sensitivity to moving objects. Higher sensitivity settings are expected to detect slight movements while smaller sensitivity settings will neglect them. When the sensitivity is set to 70%, the Network Camera defines the pixels in the purple areas as “alerted pixels” (frame D).

Percentage is a value that expresses the proportion of “alerted pixels” to all pixels in the motion detection window. In this case, 50% of pixels are identified as “alerted pixels”. When the percentage is set to 30%, the motions are judged to exceed the defined threshold; therefore, the motion window will be outlined in red.

For applications that require a high level of security management, it is suggested to use higher sensitivity settings and smaller percentage values.

Camera Tampering Detection

This section explains how to set up camera temper detection. With tamper detection, the camera is capable of detecting incidents such as **redirection, blocking or defocusing**, or even **spray paint**.

Camera tampering detection

Enable camera tampering detection

Trigger duration: seconds [10~600]

Please follow the steps below to set up the camera tamper detection function:

1. Check **Enable camera tampering detection**.
2. Enter the tamper trigger duration. (10 sec. ~ 10 min.) The tamper alarm will be triggered only when the tampering factor (the difference between current frame and pre-saved background) exceeds the trigger threshold.
3. Set up the event source as Camera Tampering Detection on **Application page > Event Settings / Server Settings (how to send alarm message) / Media Settings (send what type of alarm message)**. Please refer to page 81 for detailed information.

Camera Control

This section explains how to control the Network Camera’s Pan/Tilt/Zoom operation.

There are two ways to enable the camera control function:

1. Mechanical: Connect the Network Camera to a PTZ driver or scanner via RS485 interface.
2. Digital: Control the e-PTZ operation. It allows users to quickly move the focus to a target area for close-up viewing without moving the camera physically. Please refer to page 74 for detailed instruction.

Mechanical PTZ Operation

If you select “Mechanical“, the RS485 Settings section will be displayed as shown below:

Activated mode :

RS485 Settings

Disable

PTZ camera

Transparent HTTP Tunnel

RS485 Settings

Disable: Select this option to disable this function.

PTZ camera: Select this option to enable PTZ operation.

To utilize this feature, please connect the Network Camera to a PTZ driver or scanner via RS485 interface first. Then you can configure the PTZ driver and RS485 port with the following settings.

PTZ camera

Transparent HTTP Tunnel

Camera ID:

PTZ driver:

Port settings:

Baud rate:

Data bits:

Stop bits:

Parity bit:

VIVOTEK offers three PTZ drivers: DynaDome/SmartDOME, Lilin PIH-7x00, and Pelco D protocol. If none of the above PTZ drivers is supported by your PTZ scanner, please select **Custom camera** (scanner). Please refer to the user’s manual of your PTZ scanner to determine the Camera ID, PTZ driver, and Port settings. The Camera ID is necessary to control multiple cameras. If you click **Save** to enable this function, the camera control panel will be displayed on the main page. Please refer to the illustration on page 71.

Transparent HTTP Tunnel: If you want to use your own RS-485 device, you can use UART commands to build a Transparent HTTP Tunnel. The UART commands will be sent through HTTP tunnel established between the RS-485 device and the linked camera. For detailed application notes, please refer to URL Commands on page 105 or http://www.vivotek.com/downloadfiles/faq/videoserver/UART_HTTP_Tunnel.pdf.

Transparent HTTP Tunnel

Port settings:

Baud rate: 9600

Data bits: 8

Stop bits: 1

Parity bit: none

Preset Positions

If you select DynaDome/SmartDOME, Lilin PIH-7x00, or Pelco D protocol as the PTZ driver and click the **Save** button, the **Preset Position** button will be enabled. Click **Preset Position** to open the settings page. You can also select preset positions for the camera to patrol. A total of 20 preset positions can be configured.

Please follow the steps below to preset a position:

1. Adjust the shooting area to the desired position using the buttons on the right side of the window.
2. Enter a name for the preset position, which allows for up to forty characters. Click **Add** to enable the settings. The preset positions will be displayed under the Preset Location list on the left-hand side.
3. To add additional preset positions, please repeat steps 1~2.
4. To remove a preset position from the list, select it from the drop-down list and click **Delete**.
5. The preset positions will also displayed on the main page. Please refer to the illustration on the next page.
6. Click **Save** to enable the settings.

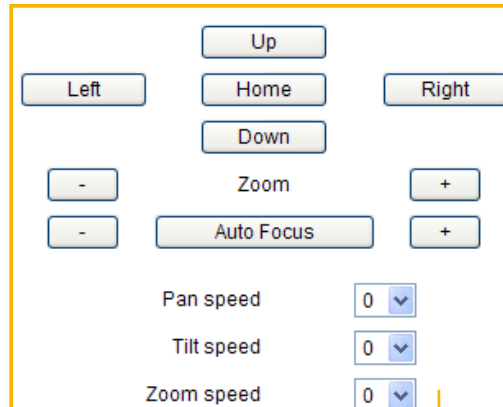
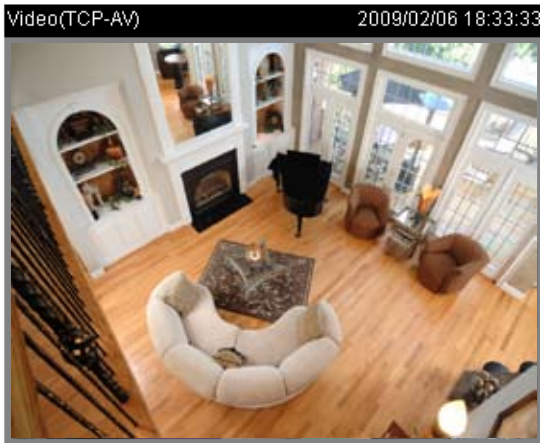

1 Functions are the same as the Control Panel on the home page

Patrol selection:

2

Preset locations	Selected locations	
	Source	Dwelling time (sec):

6 Save

Remove Up Down 0 Update

2

Preset position name: Add

4

Preset Position:

Go to Delete

Home page in Mechanical PTZ Mode

The screenshot displays the VIVOTEK web interface for a Mega-Pixel Network Camera in Mechanical PTZ Mode. The main area shows a live video feed of a living room. The left sidebar contains various controls:

- Video Stream: 1
- Digital Output: On/Off
- PTZ Panel: Mechani
- Navigation: A central cross-shaped directional pad.
- Zoom: - Zoom +
- Focus: - Focus +
- Pan: Stop, Patrol
- Pan speed: 0
- Tilt speed: 0
- Zoom speed: 0
- Client Settings, Configuration, Language
- Powered by VIVOTEK

At the bottom of the video feed, there is a toolbar with icons for home, zoom, play/pause, stop, record, pan, volume, mute, and a 'Go to' dropdown menu. The 'Go to' menu is open, showing the following options:

- Select one --
- Select one --
- up
- right
- down
- left

- The Preset Positions will also be displayed on the home page. Select one from the drop-down list, and the Network Camera will move to the selected preset position.

Patrol Settings

You can select some preset positions for the Network Camera to patrol.

Please follow the steps below to set up a patrol schedule:

1. Click a preset location on the list and click **Select**.
2. The selected preset location will be displayed on the **Source** list.
3. Set the **Dwelling time** for the preset location during auto patrol. You can also manually enter a value in the blank and click **Update**.
4. Repeat step 1 and 3 to select additional preset locations.
5. If you want to delete a selected location, select it from the Source list and click **Remove**.
6. Select a location and click **Up** or **Down** to rearrange the patrol order.
7. Click **Save** to enable the settings.



Control panel for the camera with the following buttons and settings:

- Left, Home, Right, Up, Down
- Zoom: - (minus), + (plus)
- Auto Focus: - (minus), + (plus)
- Pan speed: 0 (dropdown)
- Tilt speed: 0 (dropdown)
- Zoom speed: 0 (dropdown)

Patrol selection:

Patrol selection dialog box with the following components:

Preset locations	Selected locations	
up right down left	Source	Dwelling time (sec):
	right	10
	left	10
Select	Remove	Up
	Down	10
		Update

Additional controls and fields:

- Save (7)
- Close
- Preset position name: Add
- Preset Position: up (dropdown)
- Go to, Delete

Custom Command

If **Custom Camera (scanner)** is selected as the PTZ driver, the **Preset Position** and **PTZ Control Panel** on the main page will be disabled. You will need to configure command buttons to control the PTZ scanner. Click **Custom Command** to open the Custom Command page to set the commands in the Control Settings session. Please refer to your PTZ scanner user's manual to enter the commands in the following fields. Click **Save** to enable the settings and click **Close** to exit the page.

Control settings:

Up	<input type="text"/>
Down	<input type="text"/>
Left	<input type="text"/>
Right	<input type="text"/>
Home	<input type="text"/>
Zoom in	<input type="text"/>
Zoom out	<input type="text"/>
Closer focus	<input type="text"/>
More distant focus	<input type="text"/>
Auto Focus	<input type="text"/>

NOTE

► If you select DynaDome/SmartDOME, Lilin PIH-7x00, or Pelco D protocol as the PTZ driver, the Control Settings column will not be displayed.

► For all PTZ drivers, a total of five additional command buttons can be configured.

Leaving the "Button name" field empty means the command button will not be displayed in the homepage.

	Button name	Command
Command 1:	<input type="text" value="Upleft"/>	<input type="text"/>
Command 2:	<input type="text" value="Upright"/>	<input type="text"/>
Command 3:	<input type="text" value="Downleft"/>	<input type="text"/>
Command 4:	<input type="text" value="Downright"/>	<input type="text"/>
Command 5:	<input type="text"/>	<input type="text"/>

► The command buttons will be displayed on the main page:

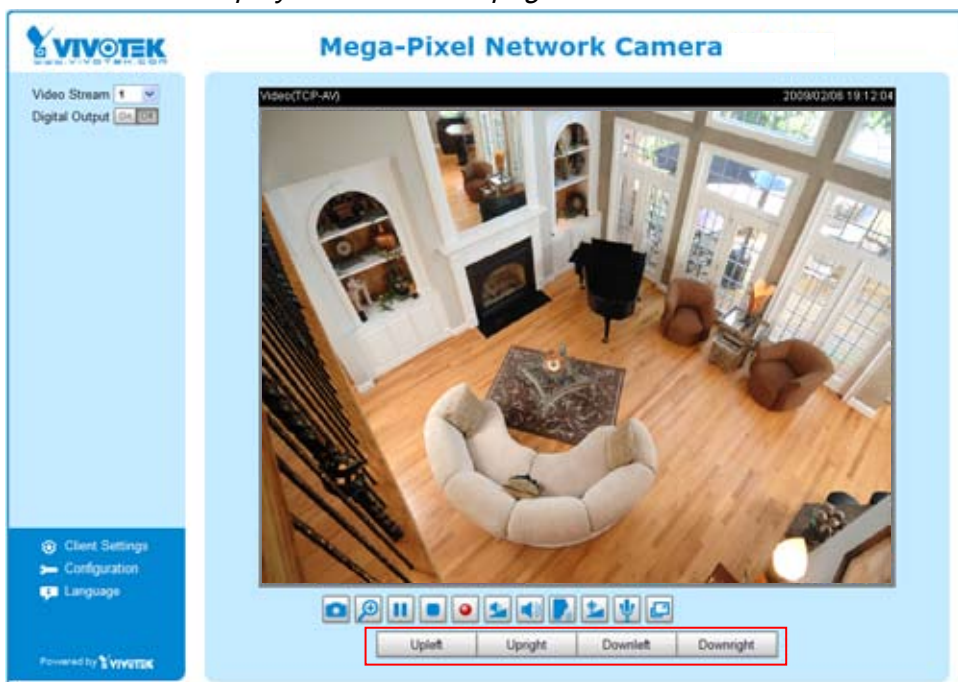

E-PTZ Operation

If you select “Digital”, the e-PTZ control settings section will be displayed as shown below:

Activated mode : Digital

Select stream : 1

(TCP-AV) 2009/05/13 19:52:41



Up

Left Home Right

Down

- Zoom +

Pan speed 0

Tilt speed 0

Zoom speed 0

Auto pan/patrol speed 1

Zoom times display

Patrol settings

Preset locations	Selected locations	
	Source	Dwelling time
Select	Remove Up Down	10 Update

Save

Preset position name

Preset Position

Select Stream: Select one of the stream 1~3 to set up the e-PTZ control. Please note that **each stream can be set up with its own e-preset positions and e-patrol settings**. For detailed information about how to set up **Preset Positions** and **Patrol Settings**, please refer to page 70~72.

Zoom Times Display

If you check this item, the zoom indicator will be displayed on the home page when you zoom in/out the live viewing window as the picture shown on the next page.

When completed with the settings of e-PTZ, click **Save** to enable the settings on this page.

Home page in E-PTZ Mode

- The e-Preset Positions will also be displayed on the home page. Select one from the drop-down list, and the Network Camera will move to the selected e-preset position.
- If you have set up different e-preset positions for stream 1~3, you can select one of the video streams to display its separate e-preset positions.

Global View

In addition to using the e-PTZ control panel, you can also use the mouse to drag or resize the floating frame to pan/tilt/zoom the viewing region. The live view window will also move to the viewing region accordingly.

Moving Instantly

If you check this item, the live view window will switch to the new viewing region instantly after you move the floating frame.

Click on Image

The e-PTZ function also supports "Click on Image". When you click on any point of the Global View Window or Live View Window, the viewing region will also move to that point.

Homepage Layout Advanced Mode

This section explains how to set up your own customized homepage layout.

Preview

This column shows the settings of your homepage layout. You can manually select the background and font colors in Theme Options (the third column on this page). The settings will be displayed automatically in this Preview field. The following shows the homepage using the default settings:



Hide Powered by VIVOTEK

- **Hide Powered by VIVOTEK:** If you check this item, it will be removed from the homepage.



Logo

Here you can change the logo at the top of your homepage.

Logo graph

You can upload a small logo(Gif, JPG or PNG), which will be resized to 160x50 pixels (if it is not already that size) and which will be visible on the main page. Upload a new logo will replace the old custom logo (if there was one uploaded)

Default
 Custom

Logo link:

Follow the steps below to upload a new logo:

1. Click **Custom** and the Browse field will appear.
2. Select a logo from your files.
3. Click **Upload** to replace the existing logo with a new one.
4. Enter a website link if necessary.
5. Click **Save** to enable the settings.

Theme Options

Here you can change the color of your homepage layout. There are three types of preset patterns for you to choose from. The new layout will simultaneously appear in the **Preview** filed. Click **Save** to enable the settings.

Theme Options

Themes

Custom

Color:

Font color:	#000000
Font color of configuration area:	#ffffff
Font color of video title:	#098bd6
Bk color of control area:	#c4eaff
Bk color of configuration area:	#0186D1
Bk color of video area:	#c4eaff
Frame color:	#0186D1

Preview

VIVOTEK
www.vivotek.com

Video Stream 1

Digital Output On Off

Client Settings

Powered by **VIVOTEK**

Mega-Pixel Network

Preview

VIVOTEK
www.vivotek.com

Video Stream 1

Digital Output On Off

Client Settings

Powered by **VIVOTEK**

Mega-Pixel Network

Preview

VIVOTEK
www.vivotek.com

Video Stream 1

Digital Output On Off

Client Settings

Powered by **VIVOTEK**

Mega-Pixel Network

Preview

VIVOTEK
www.vivotek.com

Video Stream 1

Digital Output On Off

Client Settings

Powered by **VIVOTEK**

Mega-Pixel Network

User's Manual - 77

- Follow the steps below to set up the customized homepage:
 - Click **Custom** on the left column.
 - Click the field where you want to change the color on the right column.

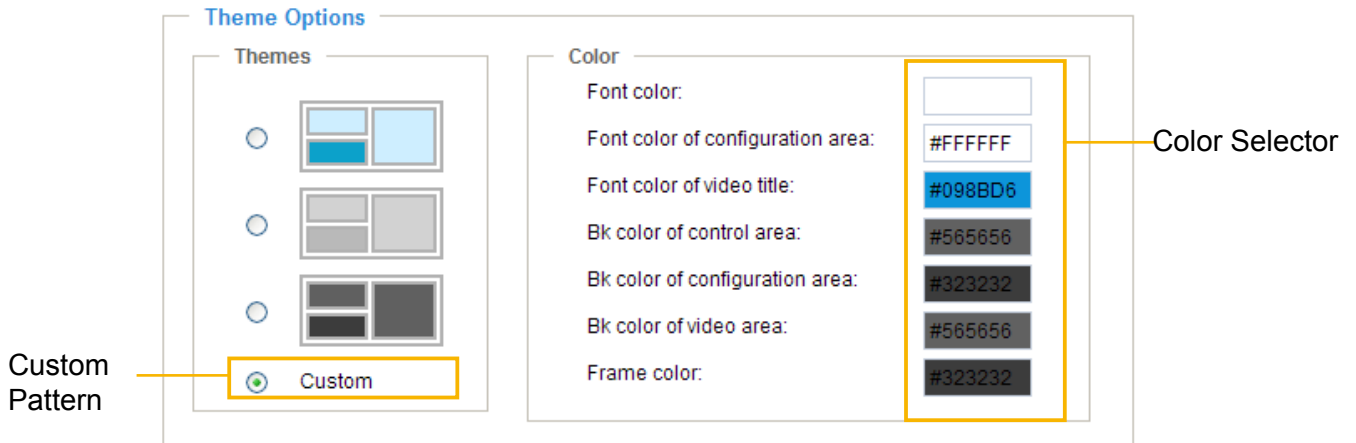

- The palette window will pop up as shown below.

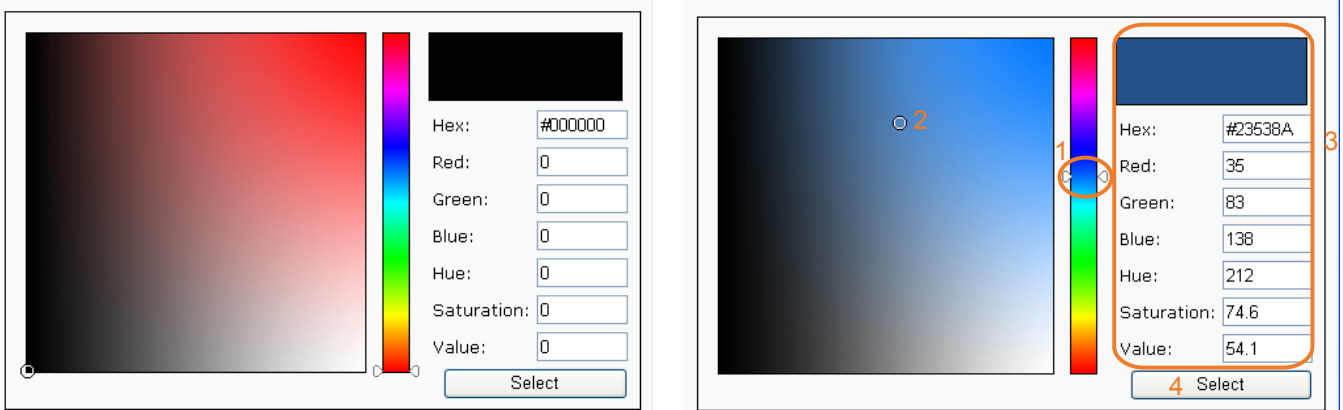

- Drag the slider bar and click on the left square to select a desired color.
- The selected color will be displayed in the corresponding fields and in the **Preview** column.
- Click **Save** to enable the settings.

Application Advanced Mode

This section explains how to configure the Network Camera to respond to particular situations (event). A typical application is that when a motion is detected, the Network Camera sends buffered images to an FTP server or e-mail address as notifications.

In the illustration on the right, an event can be triggered by many sources, such as motion detection or external digital input devices. When an event is triggered, you can specify what type of action that will be performed. You can configure the Network Camera to send snapshots or videos to your email address or FTP site.

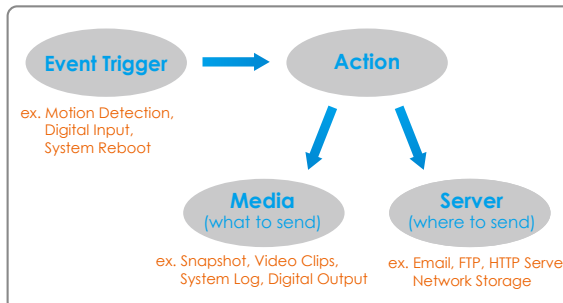

Event Settings

Name	Status	Sun	Mon	Tue	Wed	Thu	Fri	Sat	Time	Trigger
<input type="button" value="Add"/> <input type="button" value="Help"/>										

Customized Script

Name	Date	Time
<input type="button" value="Add"/> <input type="button" value="▼"/> <input type="button" value="Delete"/>		

Customized Script

This function allows you to upload a sample script (.xml file) to the webpage, which will save your time on configuring the settings. Please note that there is a limited number of customized scripts you can upload; if the current amount of customized scripts has reached the limit, an alert message will pop up. If you need more information, please ask for VIVOTEK technical support.

Customized Script

Name	Date	Time
User1	20081113	18:13:46
User2	20081113	18:11:32

```

<?xml version="1.0" encoding="UTF-8"?>
<eventmgr version="0102">
<maxprocess>1</maxprocess>
<!-- From 08:30:00-20:30:00 on Monday to Friday every week -->
<schedule id="0">
<duration>
<weekday>1-5</weekday>
<time>08:30:00-20:30:00</time>
</duration>
</schedule>
<!-- Motion -->
<action condition="0">
<status id="0">trigger</status>
<status id="1">trigger</status>
</motion>
<event id="0">
<description>Mail system log to email address</description>
<condition>0</condition>
<scheduleid>0</scheduleid>
<delay>10</delay>
<!-- users can send email with title "Motion" to recipient gudding.yang@vivotek.com. The body of mail is the log messages -->
<process>
/usr/bin/ncpclient -s "Motion" -f IP@159@vivotek.com -b /var/log/messages -S ma.vivotek.tw -H S gudding.yang@vivotek.com
</process>
<priority>0</priority>
</event>
</eventmgr>
                
```

Click to upload a file →

Click to modify the script online →

Event Settings

In the **Event Settings** column, click **Add** to open the **Event Settings** page. On this page, you can arrange three elements -- Trigger, Schedule, and Action to set an event. A total of 3 event settings can be configured.

Event name:

Enable this event

Priority:

Detect next event after second(s).

Note: This can only applied to motion detection and digital input

Trigger

Video motion detection:

Periodically:

Digital input

System boot

Recording notify

Camera tampering detection:

Event Schedule

Sun Mon Tue Wed Thu Fri Sat

Time

Always

From to [hh:mm]

Action

Trigger digital output for seconds

Server	Media	Extra parameter
<input type="checkbox"/> SD	<input type="text" value="None"/>	<input type="button" value="SD Test"/> <input type="button" value="View"/>

Event name: Enter a name for the event setting.

Enable this event: Select this option to enable the event setting.

Priority: Select the relative importance of this event (High, Normal, or Low). Events with a higher priority setting will be executed first.

Detect next event after seconds: Enter the duration in seconds to pause motion detection after a motion is detected.

An event is an action initiated by a user-defined trigger source; it is the causal arrangement of the following three elements: Trigger, Event Schedule, and Action.

Trigger

This is the cause or stimulus which defines when to trigger the Network Camera. The trigger source can be configured to use the Network Camera’s built-in motion detection mechanism or external digital input devices.

There are several choices of trigger sources as shown below. Select the item to display the detailed configuration options.

■ Video motion detection

This option makes use of the built-in motion detection mechanism as a trigger source. To enable this function, you need to configure a Motion Detection Window first. For more information, please refer to Motion Detection on page 65 for details.

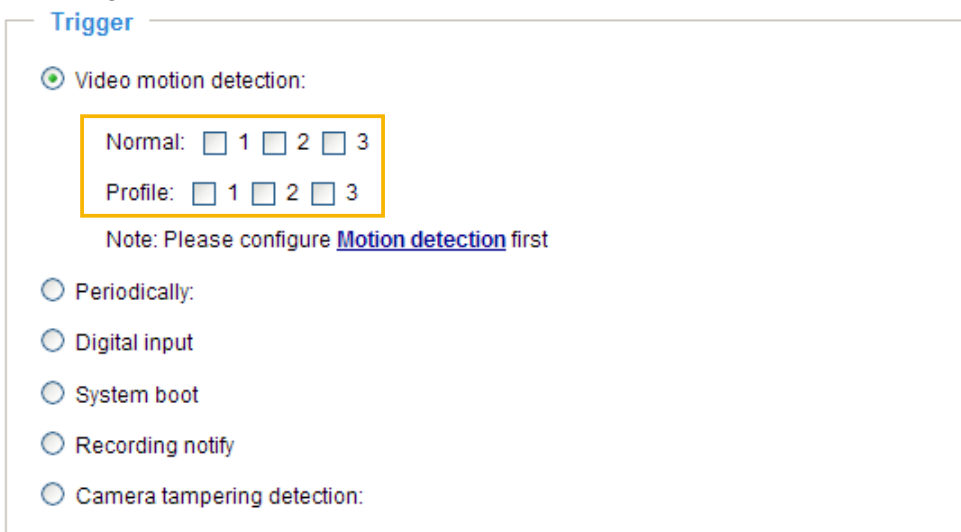

■ Periodically

This option allows the Network Camera to trigger periodically for every other defined minute. Up to 999 minutes are allowed.

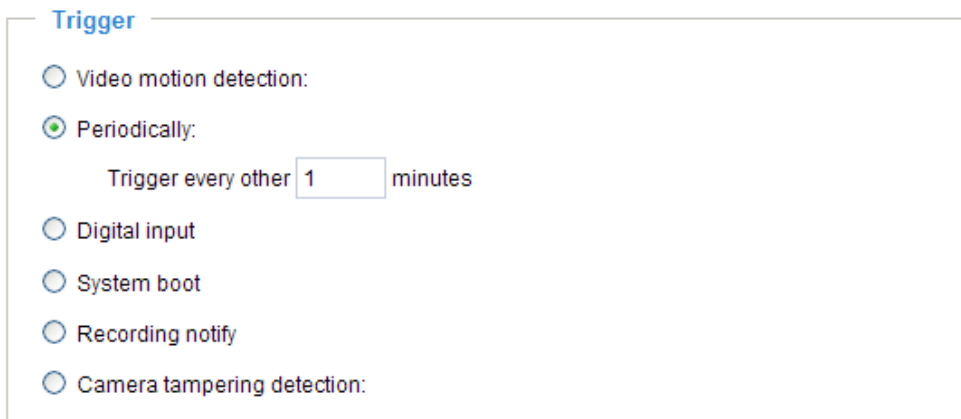

■ Digital input

This option allows the Network Camera to use an external digital input device or sensor as a trigger source. Depending on your application, there are many choices of digital input devices on the market which helps to detect changes in temperature, vibration, sound, and light, etc.

■ System boot

This option triggers the Network Camera when the power to the Network Camera is disconnected.

■ Recording notify

This option allows the Network Camera to trigger when the recording disk is full or when recording starts to rewrite older data. If you want receive **Recording notify message**, please refer to page 90 for detailed information.

■ Camera tampering detection

This option allows the Network Camera to trigger when the camera detects that is is being tampered with. To enable this function, you need to configure the Tampering Detection option first. Please refer to page 68 for detailed information.

Trigger

- Video motion detection:
- Periodically:
- Digital input
- System boot
- Recording notify
- Camera tampering detection:

Note: Please configure [Camera tampering detection](#) first

[Event Schedule](#)

Specify the period for the event.

Event Schedule

Sun Mon Tue Wed Thu Fri Sat

Time

Always

From to [hh:mm]

■ Select the days of the week.

■ Select the recording schedule in 24-hr time format.

[Action](#)

Define the actions to be performed by the Network Camera when a trigger is activated.

Action

Trigger digital output for seconds

Server	Media	Extra parameter
<input type="checkbox"/> SD	-----None-----	<input type="button" value="SD Test"/> <input type="button" value="View"/>

■ Trigger digital output for seconds

Select this option to turn on the external digital output device when a trigger is activated. Specify the length of the trigger interval in the text box.

To set an event with recorded video or snapshots, it is necessary to configure the server and media settings so that the Network Camera will know what action to take (such as which server to send the media files to) when a trigger is activated.

■ Add Server / Add Media

Click **Add Server** to configure [Server Settings](#). For more information, please refer to Server Settings on page 85.

Click **Add Media** to configure [Media Settings](#). For more information, please refer to Media Settings on page 88.

Here is an example of the Event Settings page:

Event name:

Enable this event

Priority:

Detect next event after second(s).

Note: This can only applied to motion detection and digital input

Trigger

Video motion detection

Periodically

Digital input

System boot

Recording notify

Camera tampering detection

Event Schedule

Sun Mon Tue Wed Thu Fri Sat

Time

Always

From To [hh:mm]

Action

Trigger digital output for seconds

Server	Media	Extra parameter
<input type="checkbox"/> SD	<input type="text" value="----None----"/>	<input type="button" value="SD Test"/> <input type="button" value="View"/>
<input type="checkbox"/> FTP	<input type="text" value="----None----"/>	
<input type="checkbox"/> NAS	<input type="text" value="----None----"/>	<input type="checkbox"/> Create folders by date time and hour automatically <input type="button" value="View"/>
<input type="checkbox"/> Email	<input type="text" value="----None----"/>	
<input type="checkbox"/> HTTP	<input type="text" value="----None----"/>	

When completed, click **Save** to enable the settings and click **Close** to exit Event Settings page. The new event settings / server settings / media settings will appear in the event drop-down list on the Application page.

Here is an example of the Application page with an event setting:

Event Settings

Name	Status	Sun	Mon	Tue	Wed	Thu	Fri	Sat	Time	Trigger
Event1	ON	V	V	V	V	V	V	V	00:00~24:00	di

Server Settings

Name	Type	Address/Location
FTP	ftp	ftp.vivotek.com
NAS	ns	\\192.168.5.122\nas
Email	email	Ms.vivotek.tw
HTTP	http	http://192.168.5.10/cgi-bin/upload.cgi

Media Settings

Available memory space: 8000KB

Name	Type
Snapshot	snapshot
Video Clip	videoclip
System log	systemlog
Recording notify	recordmsg

Customized Script

Name	Date	Time
------	------	------

When the Event Status is **ON**, once an event is triggered by motion detection, the Network Camera will automatically send snapshots via e-mail.

If you want to stop the event trigger, you can click **ON** to turn it to **OFF** status or click **Delete** to remove the event setting.

To remove a server setting from the list, select a server name from the drop-down list and click **Delete**. Note that only when the server setting is not being applied to an event setting can it be deleted.

To remove a media setting from the list, select a media name from the drop-down list and click **Delete**. Note that only when the media setting is not being applied to an event setting can it be deleted.

Server Settings

Click **Add Server** on Event Settings page to open the Server Setting page. On this page, you can specify where the notification messages are sent when a trigger is activated. A total of 5 server settings can be configured.

Server name: Enter a name for the server setting.

Server Type

There are four choices of server types available: Email, FTP, HTTP, and Network storage. Select the item to display the detailed configuration options. You can configure either one or all of them.

Email: Select to send the media files via email when a trigger is activated.

Server name:

Server Type

Email:

Sender email address:

Recipient email address:

Server address:

User name:

Password:

Server port:

This server requires a secure connection (SSL)

FTP:

HTTP:

Network storage:

- Sender email address: Enter the email address of the sender.
- Recipient email address: Enter the email address of the recipient.
- Server address: Enter the domain name or IP address of the email server.
- User name: Enter the user name of the email account if necessary.
- Password: Enter the password of the email account if necessary.
- Server port: The default mail server port is set to 25. You can also manually set another port.

If your SMTP server requires a secure connection (SSL), check **This server requires a secure connection (SSL)**.

To verify if the email settings are correctly configured, click **Test**. The result will be shown in a pop-up window. If successful, you will also receive an email indicating the result.

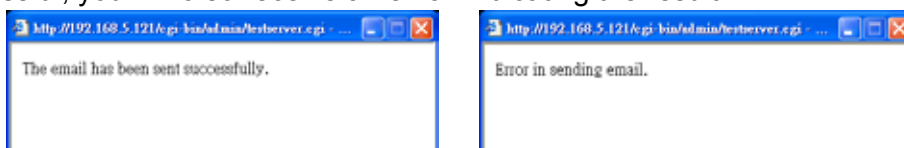

Click **Save** to enable the settings, then click **Close** to exit the page.

FTP: Select to send the media files to an FTP server when a trigger is activated.

Server name:

Server Type

Email:

FTP:

Server address:

Server port:

User name:

Password:

FTP folder name:

Passive mode

HTTP:

Network storage:

- **Server address:** Enter the domain name or IP address of the FTP server.
- **Server port**
By default, the FTP server port is set to 21. It can also be assigned to another port number between 1025 and 65535.
- **User name:** Enter the login name of the FTP account.
- **Password:** Enter the password of the FTP account.
- **Remote folder name**
Enter the folder where the media file will be placed. If the folder name does not exist, the Network Camera will create one on the FTP server.
- **Passive mode**
Most firewalls do not accept new connections initiated from external requests. If the FTP server supports passive mode, select this option to enable passive mode FTP and allow data transmission to pass through the firewall.

To verify if the FTP settings are correctly configured, click **Test**. The result will be shown in a pop-up window as shown below. If successful, you will also receive a test.txt file on the FTP server.



Click **Save** to enable the settings, then click **Close** to exit the page.

HTTP: Select to send the media files to an HTTP server when a trigger is activated.

Server name:

Server Type

Email:

FTP:

HTTP:

URL:

User name:

Password:

Network storage:

- URL: Enter the URL of the HTTP server.
- User name: Enter the user name if necessary.
- Password: Enter the password if necessary.

To verify if the HTTP settings are correctly configured, click **Test**. The result will be shown in a pop-up window as below. If successful, you will receive a test.txt file on the HTTP server.



Click **Save** to enable the settings, then click **Close** to exit the page.

Network storage: Select to send the media files to a network storage location when a trigger is activated. Please refer to **Network Storage Setting** on page 92 for details.

Click **Save** to enable the settings, then click **Close** to exit the page.

When completed, the new server settings will automatically be displayed on the Event Settings page. For example:

	Server	Media	Extra parameter
<input type="checkbox"/>	SD	-----None-----	<input type="button" value="SD Test"/> <input type="button" value="View"/>
<input type="checkbox"/>	FTP	-----None-----	
<input type="checkbox"/>	NAS	-----None-----	<input type="checkbox"/> Create folders by date time and hour automatically <input type="button" value="View"/>
<input type="checkbox"/>	Email	-----None-----	
<input type="checkbox"/>	HTTP	-----None-----	

Media Settings

Click **Add Media** on the Event Settings page to open the Media Settings page. On this page, you can specify the type of media that will be sent when a trigger is activated. A total of 5 media settings can be configured.

Media name: Enter a name for the media setting.

Media Type

There are three choices of media types available: Snapshot, Video Clip, and System log. Select the item to display the detailed configuration options. You can configure either one or all of them.

Snapshot: Select to send snapshots when a trigger is activated.

Media name:

Media Type

Snapshot

Source:

Send pre-event image(s) [0~7]

Send post-event image(s) [0~7]

File name prefix:

Add date and time suffix to file name

Video Clip

System log

Recording notify message

- Source: Select to take snapshots from stream 1 ~ 4.
- Send pre-event images
The Network Camera has a buffer area; it temporarily holds data up to a certain limit. Enter a number to decide how many images to capture before a trigger is activated. Up to 7 images can be generated.
- Send post-event images
Enter a number to decide how many images to capture after a trigger is activated. Up to 7 images can be generated.

For example, if both the Send pre-event images and Send post-event images are set to 7, a total of 15 images are generated after a trigger is activated.

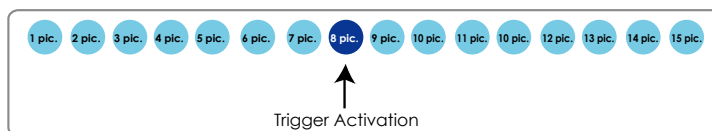

- File name prefix
Enter the text that will be appended to the front of the file name.
- Add date and time suffix to the file name
Select this option to add a date/time suffix to the file name.

For example:

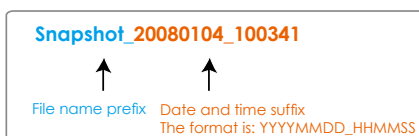

Click **Save** to enable the settings, then click **Close** to exit the page.

Video clip: Select to send video clips when a trigger is activated.

Media name:

Media Type

Snapshot

Video Clip

Source:

Pre-event recording: seconds [0~9]

Maximum duration: seconds [1~10]

Maximum file size: Kbytes [50~800]

File name prefix:

System log

Recording notify message

- **Source:** Select to record video clips from stream 1 ~ 4.
- **Pre-event recording**
The Network Camera has a buffer area; it temporarily holds data up to a certain limit. Enter a number to decide the duration of recording before a trigger is activated. Up to 9 seconds can be set.
- **Maximum duration**
Specify the maximum recording duration in seconds. Up to 10 seconds can be set.
For example, if pre-event recording is set to five seconds and the maximum duration is set to ten seconds, the Network Camera continues to record for another 4 seconds after a trigger is activated.

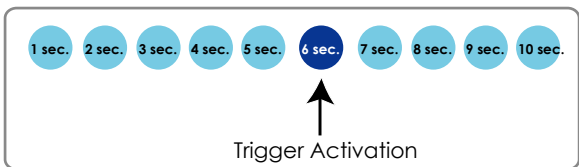

- **Maximum file size**
Specify the maximum file size allowed.
- **File name prefix**
Enter the text that will be appended to the front of the file name.
For example:



Click **Save** to enable the settings, then click **Close** to exit the page.

System log: Select to send a system log when a trigger is activated.
Click **Save** to enable the settings, then click **Close** to exit the page.

Recording notify message: Select to send a recording notification message when a trigger is activated. The following is an example of a recording notification message (.txt file), which shows a list of deleted previously-recorded data due to cycle recording.

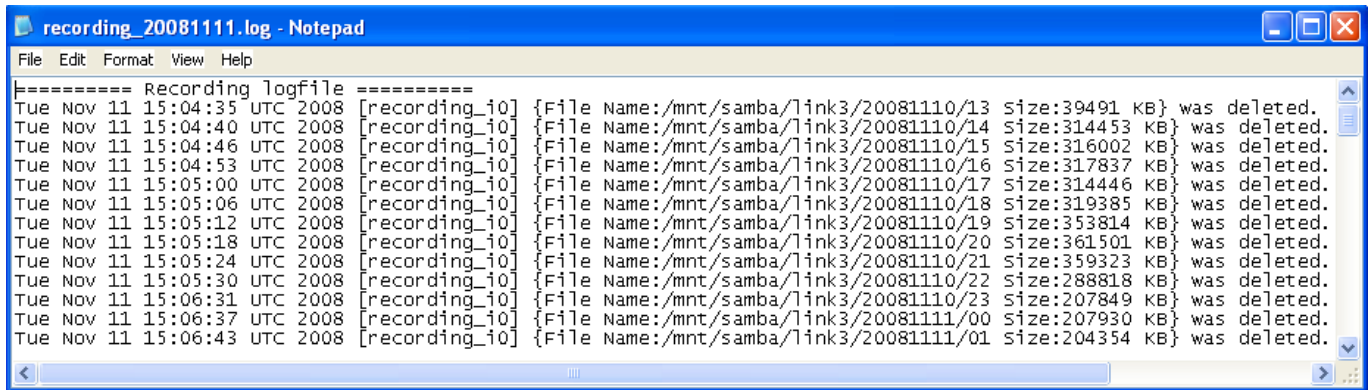

When completed, click **Save** to enable the settings and click **Close** to exit this page. The new media settings will appear on the Event Settings page.

You can continue to select a server and media type for the event. Please go back to page 66 for detailed information.

The screenshot shows a configuration form with the following elements:

- Buttons: "Add Server", "Add Media"
- Table with columns: "Server", "Media", "Extra parameter"
- Server options: SD, FTP, NAS, Email, HTTP (each with a checkbox and a dropdown menu set to "None")
- Media dropdown menu for SD: "None", "Snapshot", "Video Clip", "System log", "Recording notify"
- Buttons: "SD Test", "View" (next to SD)
- Checkbox: "Create folders by date time and hour automatically"
- Button: "View" (below the checkbox)

- **SD Test:** Click to test your SD card. The system will display a message indicating success or failure. If you want to use your SD card for local storage, please format it before use. Please refer to page 92 for detailed information.
- **Create folders by date, time, and hour automatically:** If you check this item, the system will generate folders automatically by date.
- **View:** Click this button to open a file list window. This function is only for **SD card** and **Network Storage**.

If you click **View** button of SD card, a **Local storage** page will pop up for you to manage recorded files on SD card. For more information about Local storage, please refer to page 95 for illustration.

If you click **View** button of Network storage, a **file directory window** will pop up for you to view recorded data on Network storage. For detailed illustration, please refer to the next page.

The following is an example of a file destination with video clips:

The format is: YYYYMMDD
Click to open the directory

Click to delete selected items

Click to delete all recorded data

Click [20081120](#) to open the directory:

The format is: HH (24r)
Click to open the file list for that hour

	file name	size	date	time
<input type="checkbox"/>	Recording1 58.mp4	2526004	2008/11/20	07:58:28
<input type="checkbox"/>	Recording1 59.mp4	2563536	2008/11/20	07:59:28

Click to delete selected items

Click to delete all recorded data

Click to go back to the previous level of the directory

	file name	size	date	time
<input type="checkbox"/>	Recording1 58.mp4	2526004	2008/11/20	07:58:28
<input type="checkbox"/>	Recording1 59.mp4	2563536	2008/11/20	07:59:28

The format is: File name prefix + Minute (mm)
You can set up the file name prefix on Media Settings page.
Please refer to page 88 for detailed information.

Recording Advanced Mode

This section explains how to configure the recording settings for the Network Camera.

Recording Settings

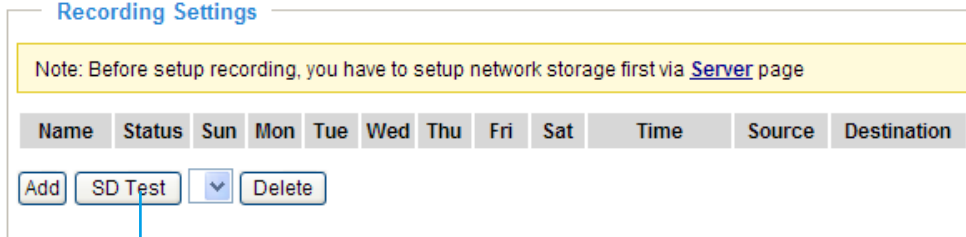

Insert your SD card and click here to test

NOTE

- ▶ Before setting up this page, please set up the Network Storage on the Server Settings page first.
- ▶ Please remember to format your SD card when using for the first time. Please refer to page 95 for detailed information.

Network Storage Setting

Click [Server](#) to open the Server Settings page and follow the steps below to set up:

1. Fill in the information for your server.

For example:

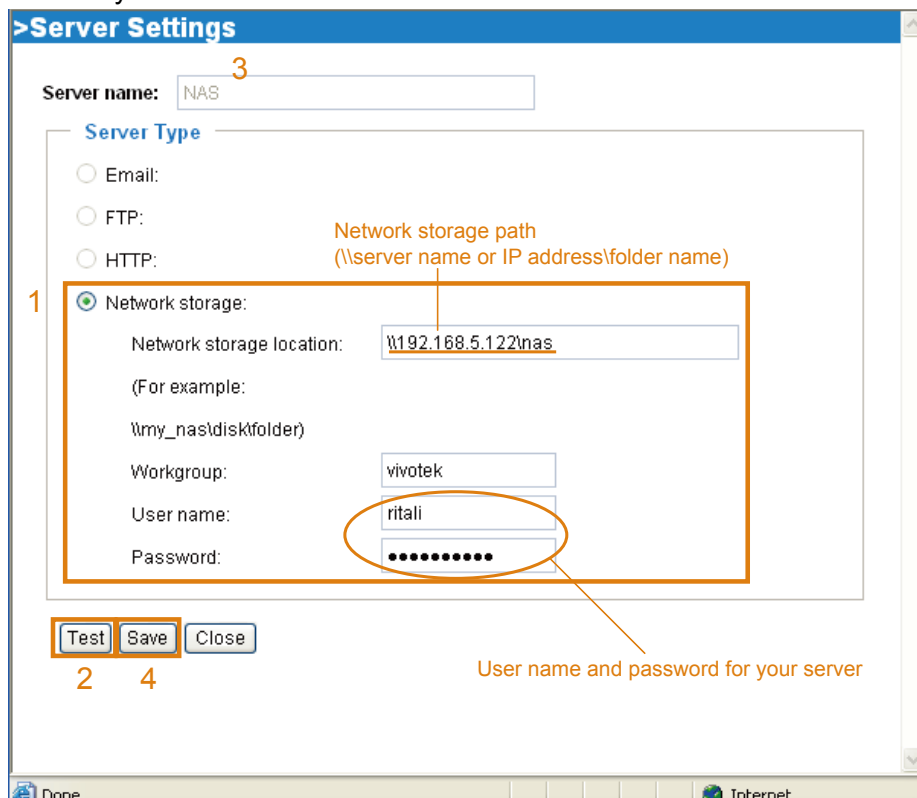

2. Click **Test** to check the setting. The result will be shown in the pop-up window.

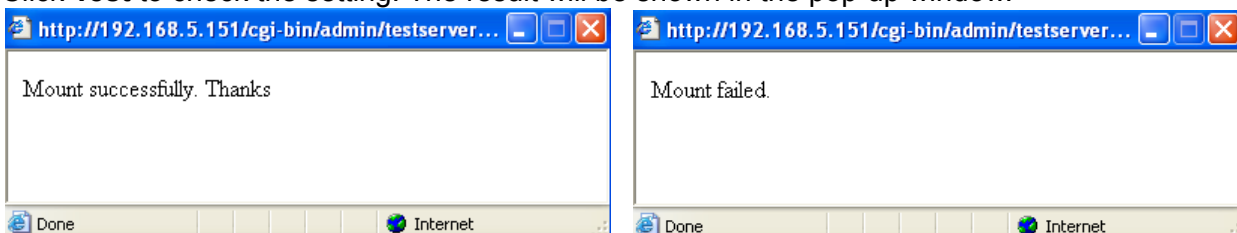

If successful, you will receive a test.txt file on the network storage server.

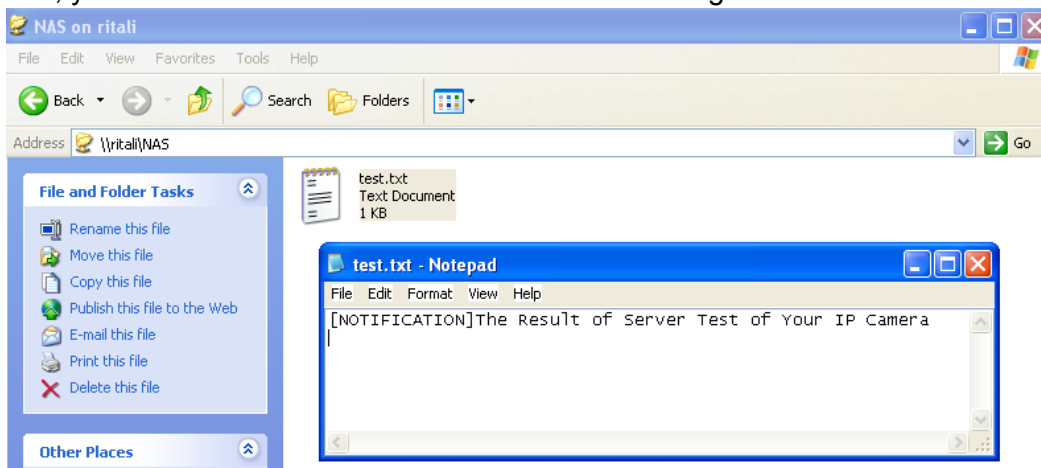

3. Enter a server name.
4. Click **Save** to complete the settings and click **Close** to exit the page.

Recording Settings

Click **Add** to open the recording setting page. In this page, you can define the recording source, recording schedule and recording capacity. A total of 2 recording settings can be configured.

Recording

Recording name:

Enable this recording

Priority:

Source:

Recording Schedule

Sun Mon Tue Wed Thu Fri Sat

Time

Always

From to [hh:mm]

Destination:

Capacity:

Entire free space

Limit recording size in Mbytes

File name prefix:

Enable cyclic recording

Reserved amount: Mbytes

Note: To enable recording notification please configure [Application](#) first

Recording name: Enter a name for the recording setting.

Enable this recording: Select this option to enable video recording.

Priority: Select the relative importance of this recording setting (High, Normal, and Low).

Source: Select the recording source (stream 1 ~ 4).

Recording Schedule: Specify the recording duration.

- Select the days of the week.
- Select the recording start and end times in 24-hr time format.

Destination: You can select the SD card or network storage that was set up for the recorded video files.

Capacity: You can choose either the entire free space available or limit the recording size. The recording size limit must be larger than the reserved amount for cyclic recording.

File name prefix: Enter the text that will be appended to the front of the file name.

Enable cyclic recording: If you check this item, when the maximum capacity is reached, the oldest file will be overwritten by the latest one. The reserved amount is reserved for cyclic recording to prevent malfunction. This value must be larger than 15 MBytes.

If you want to enable recording notification, please click [Application](#) to set up. Please refer to **Trigger > Recording notify** on page 82 for detailed information.

When completed, select **Enable this recording**. Click **Save** to enable the setting and click **Close** to exit this page. When the system begins recording, it will send the recorded files to the Network Storage. The new recording name will appear in the drop-down list on the recording page as shown below.

To remove a recording setting from the list, select a recording name from the drop-down list and click **Delete**.

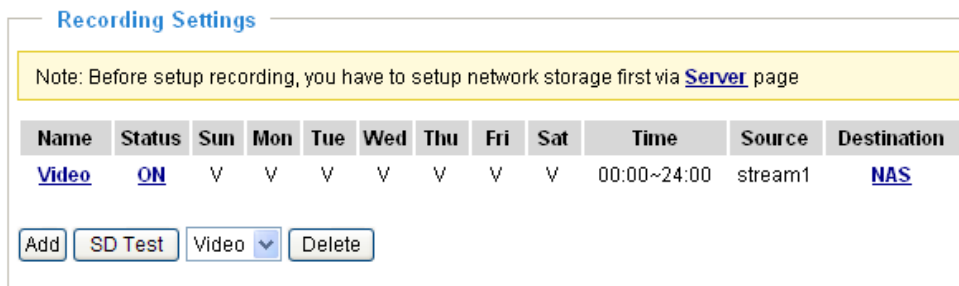

- Click [Video \(Name\)](#): Opens the Recording Settings page to modify.
- Click [ON \(Status\)](#): The Status will become [OFF](#) and stop recording.
- Click [NAS \(Destination\)](#): Opens the file list of recordings as shown below. For more information about folder naming rules, please refer to page 91 for details.

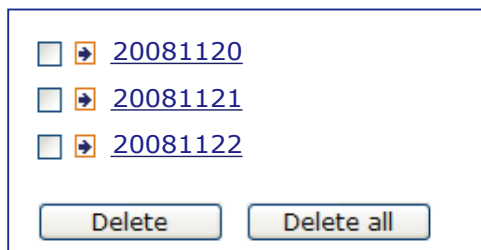

Local Storage Advanced Mode

This section explains how to manage the local storage on the Network Camera. Here you can view SD card status, search for recorded files to playback, download, etc.

SD card management

- SD card status: Detached ————— no SD card
- SD card control:

Searching and viewing the records

- File attributes:
- Trigger time:

Search

Search results

Show 10 entries Search:

Trigger time	Media type	Trigger type	Locked
No matching records found			

Showing 0 to 0 of 0 entries ◀ ▶

View

Download

Uncheck All

JPEGs to AVI

Lock/Unlock

Remove

Note: "View" and "Download" only apply to the highlight item

SD Card Management

SD card status: This column shows the status and reserved space of your SD card. Please remember to format the SD card when using for the first time.

SD card management

- ✦ SD card status: Ready

Total size:	7810152 KBytes	Free size:	7602048 KBytes
Used size:	208104 KBytes	Use (%):	2.665 %

Format

SD card control

- **Enable cyclic storage:** Check this item if you want to enable cyclic recording. When the maximum capacity is reached, the oldest file will be overwritten by the latest one.

Enable cyclic storage
 Enable automatic disk cleanup
 Maximum duration for keeping files: days

- **Enable automatic disk cleanup:** Check this item and enter the number of days you wish to retain a file. For example, if you enter "7 days", the recorded files will be stored on the SD card for 7 days.

Click **Save** to enable your settings.

Searching and Viewing the Records

This column allows the user to set up search criteria for recorded data. If you do not select any criteria and click **Search** button, all recorded data will be listed in the **Search Results** column.

Searching and viewing the records
 File attributes:
 Trigger type: Tampering Digital input Video loss
 System boot Recording notify Motion
 Periodically
 Media type: Video Clip Snapshot Text
 Locked: Locked Unlocked
 Trigger time:
 From: Date Time
 To: Date Time
(yyyy-mm-dd) (hh:mm:ss)

File attributes: Select one or more items as your search criteria.

Trigger time: Manually enter the time range you want to search.

Click **Search** and the recorded data corresponding to the search criteria will be listed in **Search Results** window.

Search Results

The following is an example of search results. There are four columns: Trigger time, Media type, Trigger type, and Locked. Click  to sort the search results in either direction.





Numbers of entries displayed on one page

Enter a key word to filter the search results



Search results

Show entries

Search:

<input type="checkbox"/>	Trigger time 	Media type 	Trigger type 	Locked 
<input type="checkbox"/>	2009-03-05 10:47:57	Videoclip	Periodically	No
<input type="checkbox"/>	2009-03-05 10:48:58	Videoclip	Periodically	No
<input type="checkbox"/>	2009-03-05 10:49:58	Videoclip	Periodically	No
<input type="checkbox"/>	2009-03-05 10:50:58	Videoclip	Periodically	No
<input type="checkbox"/>	2009-03-05 10:51:58	Videoclip	Periodically	No
<input type="checkbox"/>	2009-03-05 10:52:58	Videoclip	Periodically	No
<input type="checkbox"/>	2009-03-05 10:53:58	Videoclip	Periodically	No
<input type="checkbox"/>	2009-03-05 10:54:58	Videoclip	Periodically	No
<input type="checkbox"/>	2009-03-05 10:55:57	Videoclip	Periodically	No
<input type="checkbox"/>	2009-03-05 10:56:57	Videoclip	Periodically	No

Showing 11 to 20 of 32 entries

Highlight an item

Click to switch pages

-
-
-
-
-
-

Note: "View" and "Download" only apply to the highlight item

View: Click on a search result which will highlight the selected item in purple as shown above. Click the **View** button and a media window will pop up to play back the selected file. For example:

(Playback-V) 2009/3/5 10:47:31



Small Medium Primary Close

Click to adjust the image size

Download: Click on a search result to highlight the selected item in purple as shown above. Then click the **Download** button and a file download window will pop up for you to save the file.

JPEGs to AVI: This functions only applies to “JPEG” format files such as snapshots. You can select several snapshots from the list, then click this button. Those snapshots will be converted into an AVI file.

Lock/Unlock: Select the desired search results, then click this button. The selected items will become Locked, which will not be deleted during cyclic recording. You can click again to unlock the selections. For example:

Search results

Show entries Search:

	Trigger time	Media type	Trigger type	Locked
<input checked="" type="checkbox"/>	2009-03-05 10:47:57	Videoclip	Periodically	Yes
<input checked="" type="checkbox"/>	2009-03-05 10:48:58	Videoclip	Periodically	Yes
<input checked="" type="checkbox"/>	2009-03-05 10:49:58	Videoclip	Periodically	Yes
<input type="checkbox"/>	2009-03-05 10:50:58	Videoclip	Periodically	No
<input type="checkbox"/>	2009-03-05 10:51:58	Videoclip	Periodically	No
<input type="checkbox"/>	2009-03-05 10:52:58	Videoclip	Periodically	No
<input type="checkbox"/>	2009-03-05 10:53:58	Videoclip	Periodically	No
<input type="checkbox"/>	2009-03-05 10:54:58	Videoclip	Periodically	No
<input type="checkbox"/>	2009-03-05 10:55:57	Videoclip	Periodically	No
<input type="checkbox"/>	2009-03-05 10:56:57	Videoclip	Periodically	No

Showing 11 to 20 of 32 entries ◀ ▶

Remove: Select the desired search results, then click this button to delete the files.

System Log Advanced Mode

This section explains how to configure the Network Camera to send the system log to the remote server as backup.

Remote Log

Remote Log

Enable remote log

Log server settings

IP address:

port:

You can configure the Network Camera to send the system log file to a remote server as a log backup. Before utilizing this feature, it is suggested that the user install a log-recording tool to receive system log messages from the Network Camera. An example is Kiwi Syslog Daemon. Visit <http://www.kiwisyslog.com/kiwi-syslog-daemon-overview/>.

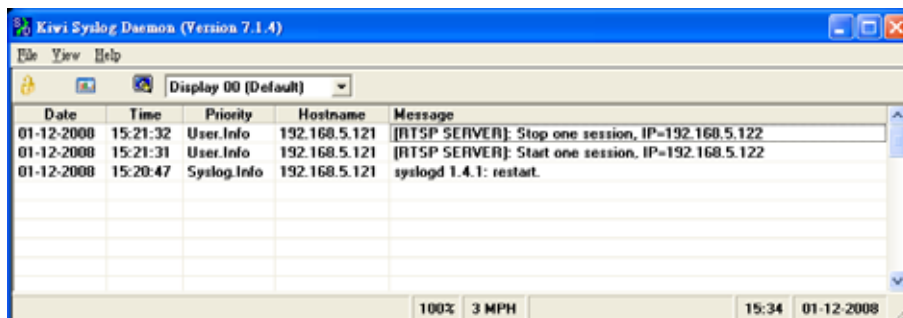

Follow the steps below to set up the remote log:

1. In the IP address text box, enter the IP address of the remote server.
2. In the port text box, enter the port number of the remote server.
3. When completed, select **Enable remote log** and click **Save** to enable the setting.

Current Log

Current Log

```

Mar 5 13:39:12 syslogd 1.5.0: restart.
Mar 5 13:39:13 [swatchdog][232]: Ready to watch httpd.
Mar 5 13:39:14 [EVENT MGR]: Starting eventmgr with support for EcTun
Mar 5 13:39:14 [DRM Service]: Starting DRM service.
Mar 5 13:39:15 [EVENT MGR]: Task conf file: there is no valid event in recording_task.xml, skip it
Mar 5 13:39:15 [EVENT MGR]: Task conf file: there is no valid event in event_task.xml, skip it
Mar 5 13:39:22 [RTSP SERVER]: XMLSParser: open failed^M
Mar 5 13:39:22 [VENC]: Failed to set auto iris control
Mar 5 13:39:25 [IR Cut Control]: Day mode
Mar 5 13:39:27 [IR Cut Control]: Day mode
Mar 5 13:39:29 [SYS]: Serial number = 0002D17161CB
Mar 5 13:39:29 [SYS]: System starts at Fri Mar 5 13:39:29 UTC 2004
Mar 5 13:39:29 [NET]: === NET INFO ===
Mar 5 13:39:29 [NET]: Host IP = 172.16.7.116
Mar 5 13:39:29 [NET]: Subnet Mask = 255.255.0.0
Mar 5 13:39:29 [NET]: Gateway = 172.16.0.1
Mar 5 13:39:29 [NET]: Primary DNS = 192.168.0.10
                    
```

This column displays the system log in chronological order. The system log is stored in the Network Camera's buffer area and will be overwritten when reaching a certain limit.

View Parameters Advanced Mode

The View Parameters page lists the entire system's parameters in alphabetical order. If you need technical assistance, please provide the information listed on this page.

Parameter List

```

system_hostname='Mega-Pixel Network Camera'
system_ledoff='0'
system_lowlight='1'
system_date='2009/05/18'
system_time='15:11:25'
system_datetime=''
system_ntp=''
system_timezoneindex='320'
system_daylight_enable='0'
system_daylight_dstactualmode='1'
system_daylight_auto_begintime='NONE'
system_daylight_auto_endtime='NONE'
system_daylight_timezones=',-360,-320,-280,-240,-241,-200,-201,-1
system_updateinterval='0'
system_info_modelname='IP7161'
system_info_extendedmodelname='IP7161'
system_info_serialnumber='0002D17161CB'
system_info_firmwareversion='IP7161-VVTK-0101c'
system_info_language_count='9'
system_info_language_i0='English'
system_info_language_i1='Deutsch'
system_info_language_i2='Español'
system_info_language_i3='Français'
system_info_language_i4='Italiano'
system_info_language_i5='日本語'
system_info_language_i6='Português'
system_info_language_i7='简体中文'
system_info_language_i8='繁體中文'
system_info_language_i9=''
system_info_language_i10=''
system_info_language_i11=''
system_info_language_i12=''
system_info_language_i13=''
system_info_language_i14=''
system_info_language_i15=''
system_info_language_i16=''

```



Maintenance

This chapter explains how to restore the Network Camera to factory default, upgrade firmware version, etc.

Reboot

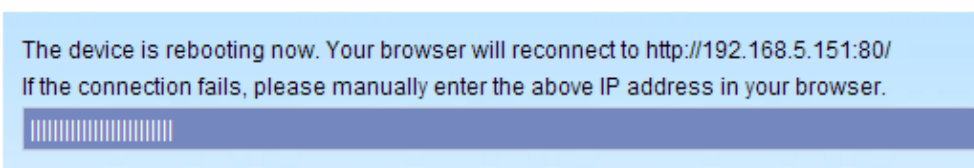

This feature allows you to reboot the Network Camera, which takes about one minute to complete. When completed, the live video page will be displayed in your browser. The following message will be displayed during the reboot process.



If the connection fails after rebooting, manually enter the IP address of the Network Camera in the address field to resume the connection.

Restore

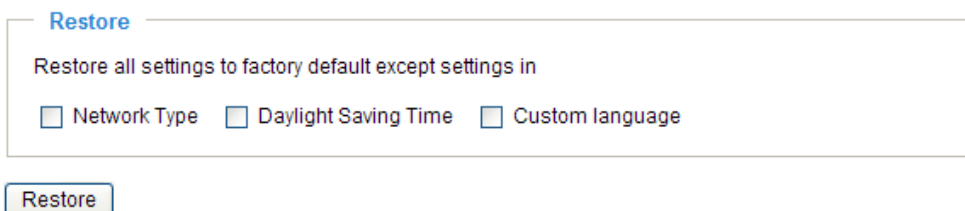

This feature allows you to restore the Network Camera to factory default settings.

Network Type: Select this option to retain the Network Type settings (please refer to Network Type on page 33).

Daylight Saving Time: Select this option to retain the Daylight Saving Time settings (please refer to System on page 24)

Custom Language: Select this option to retain the Custom Language settings.

If none of the options is selected, all settings will be restored to factory default.

The following message is displayed during the restoring process.

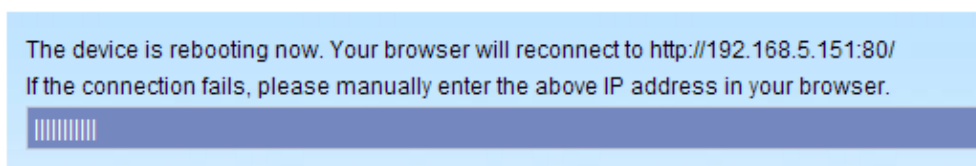

Export / Upload Files Advanced Mode

This feature allows you to Export / Upload daylight saving time rules, custom language files, and setting backup files.

Export files

Export daylight saving time configuration file	<input type="button" value="Export"/>
Export language file	<input type="button" value="Export"/>
Export setting backup file	<input type="button" value="Export"/>

Upload files

Update daylight saving time rules	<input type="text"/>	<input type="button" value="Browse..."/>	<input type="button" value="Upload"/>
Update custom language file	<input type="text"/>	<input type="button" value="Browse..."/>	<input type="button" value="Upload"/>
Upload setting backup file	<input type="text"/>	<input type="button" value="Browse..."/>	<input type="button" value="Upload"/>

Export daylight saving time configuration file: Click to set the start and end time of DST.

Follow the steps below to export:

1. In the Export files column, click **Export** to export the daylight saving time configuration file from the Network Camera.
2. A file download dialog will pop up as shown below. Click **Open** to review the XML file or click **Save** to store the file for editing.

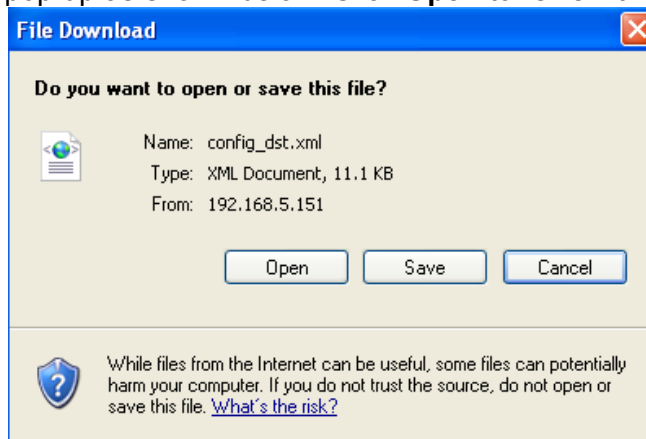

3. Open the file with Microsoft® Notepad and locate your time zone; set the start and end time of DST. When completed, save the file.

In the example below, DST begins each year at 2:00 a.m. on the second Sunday in March and ends at 2:00 a.m. on the first Sunday in November.

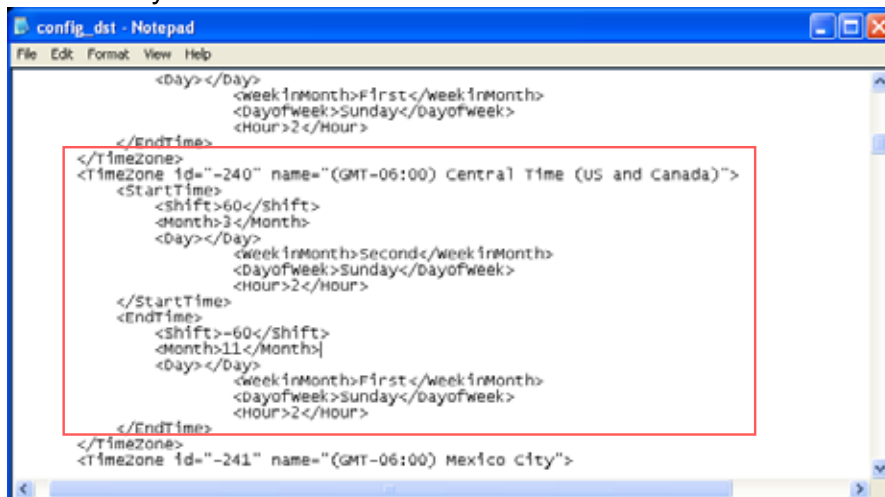

Upload daylight saving time rule: Click **Browse...** and specify the XML file to upload.

If the incorrect date and time are assigned, you will see the following warning message when uploading the file to the Network Camera.

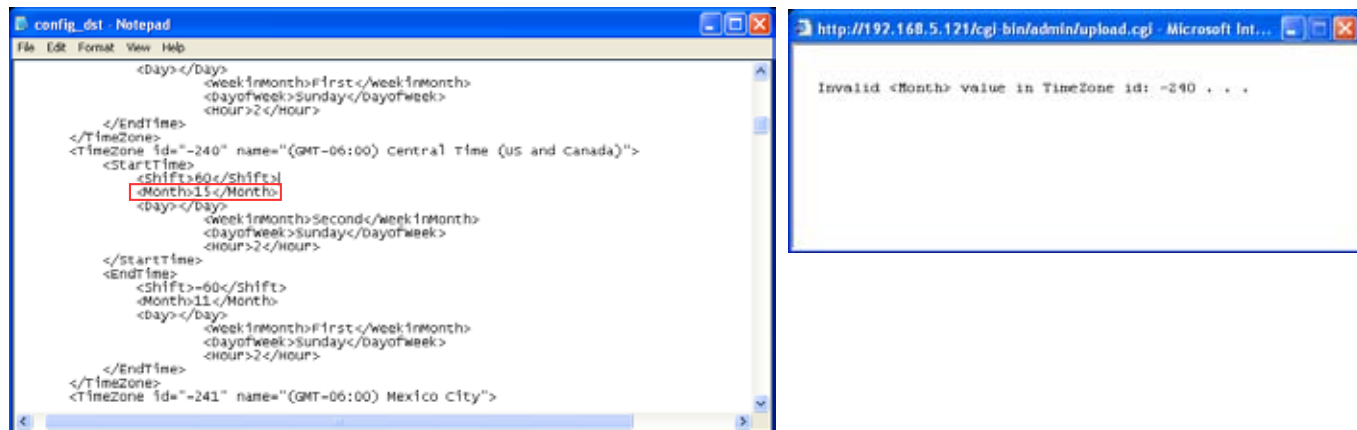

The following message is displayed when attempting to upload an incorrect file format.

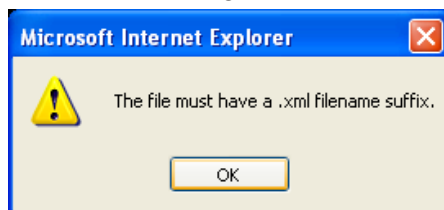

Export language file: Click to export language strings. VIVOTEK provides nine languages: English, Deutsch, Español, Français, Italiano, 日本語, Português, 簡體中文, and 繁體中文.

Upload custom language file: Click **Browse...** and specify your own custom language file to upload.

Export setting backup file: Click to export all parameters for the device and user-defined scripts.

Upload setting backup file: Click **Browse...** to upload a setting backup file. Please note that the model and firmware version of the device should be the same as the setting backup file. If you have set up a fixed IP or other special settings for your device, it is not suggested to upload a settings backup file.

Upgrade Firmware



This feature allows you to upgrade the firmware of your Network Camera. It takes a few minutes to complete the process.

Note: Do not power off the Network Camera during the upgrade!

Follow the steps below to upgrade the firmware:

1. Download the latest firmware file from the VIVOTEK website. The file is in .pkg file format.
2. Click **Browse...** and specify the firmware file.
3. Click **Upgrade**. The Network Camera starts to upgrade and will reboot automatically when the upgrade completes.

If the upgrade is successful, you will see "Reboot system now!! This connection will close". After that, re-access the Network Camera.

The following message is displayed when the upgrade has succeeded.

Reboot system now!!
This connection will close.

The following message is displayed when you have selected an incorrect firmware file.

Starting firmware upgrade...
Do not power down the server during the upgrade.
The server will restart automatically after the upgrade is completed.
This will take about 1 - 5 minutes.
Wrong PKG file format
Unpack fail

Appendix

URL Commands for the Network Camera

Overview

For some customers who already have their own web site or web control application, the Network Camera/Video Server can be easily integrated through URL syntax. This section specifies the external HTTP-based application programming interface. The HTTP-based camera interface provides the functionality to request a single image, control camera functions (PTZ, output relay etc.), and get and set internal parameter values. The image and CGI-requests are handled by the built-in Web server.

Style Convention

In URL syntax and in descriptions of CGI parameters, text within angle brackets denotes content that is to be replaced with either a value or a string. When replacing the text string, the angle brackets should also be replaced. An example of this is the description of the name for the server, denoted with `<servername>` in the URL syntax description below, that is replaced with the string `myserver` in the URL syntax example further down in the page.

URL syntax is denoted with the word "Syntax:" written in bold face followed by a box with the referenced syntax as shown below. For example, name of the server is written as `<servername>` and is intended to be replaced with the name of the actual server. This can either be a name, e.g., "mywebcam" or "thecam.adomain.net" or the associated IP number for the server, e.g., 192.168.0.220.

Syntax:

```
http://<servername>/cgi-bin/viewer/video.jpg
```

Description of returned data is written with "Return:" in bold face followed by the returned data in a box. All data is returned in HTTP format, i.e., each line is separated with a Carriage Return and Line Feed (CRLF) printed as `\r\n`.

Return:

```
HTTP/1.0 <HTTP code> <HTTP text>\r\n
```

URL syntax examples are written with "Example:" in bold face followed by a short description and a light grey box with the example.

Example: request a single snapshot image

```
http://mywebserver/cgi-bin/viewer/video.jpg
```

General CGI URL syntax and parameters

CGI parameters are written in lower-case and as one word without any underscores or other separators. When the CGI request includes internal camera parameters, the internal parameters must be written exactly as they are named in the camera or video server. The CGIs are organized in function related directories under the cgi-bin directory. The file extension of the CGI is required.

Syntax:

```
http://<servername>/cgi-bin/<subdir>[/<subdir>...]/<cgi>.<ext>
[?<parameter>=<value>[&<parameter>=<value>...]]
```

Example: Setting digital output #1 to active

```
http://mywebserver/cgi-bin/dido/setdo.cgi?do1=1
```

Security level

SECURITY LEVEL	SUB-DIRECTORY	DESCRIPTION
0	anonymous	Unprotected.
1 [view]	anonymous, viewer, dido, camctrl	1. Can view, listen, talk to camera 2. Can control dido, ptz of camera
4 [operator]	anonymous, viewer, dido, camctrl, operator	Operator's access right can modify most of camera's parameters except some privilege and network options
6 [admin]	anonymous, viewer, dido, camctrl, operator, admin	Administrator's access right can fully control the camera's operation.
7	N/A	Internal parameters. Unable to be changed by any external interface.

Get server parameter values

Note: The access right depends on the URL directory.

Method: GET/POST

Syntax:

```
http://<servername>/cgi-bin/<anonymous>/getparam.cgi?[<parameter>]
[&<parameter>...]
```

```
http://<servername>/cgi-bin/viewer/getparam.cgi?[<parameter>]
```

```
[&<parameter>...]
```

```
http://<servername>/cgi-bin/operator/getparam.cgi?[<parameter>]
```

```
[&<parameter>...]
```

```
http://<servername>/cgi-bin/admin/getparam.cgi?[<parameter>]
```

```
[&<parameter>...]
```

where the *<parameter>* should be *<group>[_<name>]* or *<group>[.<name>]* If you do not specify the any parameters, all the parameters on the server will be returned. If you specify only *<group>*, the parameters of related group will be returned.

When query parameter values, the current parameter value are returned.

Successful control request returns paramter pairs as follows.

Return:

```
HTTP/1.0 200 OK\r\n
```

```
Content-Type: text/html\r\n
```

```
Context-Length: <length>\r\n
```

```
\r\n
```

```
<parameter pair>
```

where *<parameter pair>* is

```
<parameter>=<value>\r\n
```

```
[<parameter pair>]
```

<length> is the actual length of content.

Example: request IP address and it's response

Request:

```
http://192.168.0.123/cgi-bin/admin/getparam.cgi?network_ipaddress
```

Response:

```
HTTP/1.0 200 OK\r\n
```

```
Content-Type: text/html\r\n
```

```
Context-Length: 33\r\n
```

```
\r\n
```

```
network.ipaddress=192.168.0.123\r\n
```

Set server parameter values

Note: The access right depends on the URL directory.

Method: GET/POST

Syntax:

```
http://<servername>/cgi-bin/<anonymous>/setparam.cgi? <parameter>=<value>
[&<parameter>=<value>...][&update=<value>][&return=<return page>]

http://<servername>/cgi-bin/<viewer>/setparam.cgi? <parameter>=<value>
[&<parameter>=<value>...][&update=<value>] [&return=<return page>]

http://<servername>/cgi-bin/<operator>/setparam.cgi? <parameter>=<value>
[&<parameter>=<value>...][&update=<value>] [&return=<return page>]

http://<servername>/cgi-bin/<admin>/setparam.cgi? <parameter>=<value>
[&<parameter>=<value>...][&update=<value>] [&return=<return page>]
```

PARAMETER	VALUE	DESCRIPTION
<group>_<name>	value to assigned	Assign <value> to the parameter <group>_<name>
update	<boolean>	set to 1 to actually update all fields (no need to use update parameter in each group)
return	<return page>	Redirect to the page <return page> after the parameter is assigned. The <return page> can be a full URL path or relative path according to the current path. If you omit this parameter, it will redirect to an empty page. (note: The return page can be a general HTML file(.htm, .html) or a VIVOTEK server script executable (.vspx) file. It can not be a CGI command. It can not have any extra parameters. This parameter must be put at end of parameter list)

Return:

```
HTTP/1.0 200 OK\r\n
Content-Type: text/html\r\n
Context-Length: <length>\r\n
```

```
\r\n
<parameter pair>
```

where <parameter pair> is

```
<parameter>=<value>\r\n
```

```
[<parameter pair>]
```

Only the parameters that you set and readable will be returned.

Example: Set the IP address of server to 192.168.0.123

Request:

```
http://myserver/cgi-bin/admin/setparam.cgi?network\_ipaddress=192.168.0.123
```

Response:

```
HTTP/1.0 200 OK\r\n
```

```
Content-Type: text/html\r\n
```

```
Context-Length: 33\r\n
```

```
\r\n
```

```
network.ipaddress=192.168.0.123\r\n
```

Available parameters on the server

Valid values:

VALID VALUES	DESCRIPTION
string[<n>]	Text string shorter than 'n' characters. The characters ",', <, >, & are invalid.
password[<n>]	The same as string but display '*' instead
integer	Any number between $(-2^{31} - 1)$ and $(2^{31} - 1)$
positive integer	Any number between 0 and $(2^{32} - 1)$
<m> ~ <n>	Any number between 'm' and 'n'
domain name[<n>]	A string limited to contain a domain name shorter than 'n' characters (eg. www.ibm.com)
email address [<n>]	A string limited to contain a email address shorter than 'n' characters (eg. joe@www.ibm.com)
ip address	A string limited to contain an ip address (eg. 192.168.1.1)
mac address	A string limited to contain mac address without hyphen or colon connected
boolean	A boolean value 1 or 0 represents [Yes or No], [True or False], [Enable or Disable].
<value1>, <value2>,	Enumeration. Only given values are valid.

<value3>, ...	
blank	A blank string
everything inside <>	As description

NOTE: The camera should prevent to restart when parameter changed.

Group: **system**

NAME	VALUE	SECURITY (get/set)	DESCRIPTION
hostname	string[40]	1/6	host name of server (Network Camera, Wireless Network Camera, Video Server, Wireless Video Server)
ledoff	<boolean>	6/6	turn on(0) or turn off(1) all led indicators
date	<yyyy/mm/dd>, keep, auto	6/6	Current date of system. Set to 'keep' keeping date unchanged. Set to 'auto' to use NTP to synchronize date.
time	<hh:mm:ss>, keep, auto	6/6	Current time of system. Set to 'keep' keeping time unchanged. Set to 'auto' to use NTP to synchronize time.
datetime	<MMDDhhmmYYYY.ss>	6/6	Another current time format of system.
ntp	<domain name>, <ip address>, <blank>	6/6	NTP server *do not use "skip to invoke default server" for default
timezoneindex	-489 ~ 529	6/6	Indicate timezone and area -480: GMT-12:00 Eniwetok, Kwajalein -440: GMT-11:00 Midway Island, Samoa -400: GMT-10:00 Hawaii -360: GMT-09:00 Alaska -320: GMT-08:00 Las Vegas, San_Francisco, Vancouver -280: GMT-07:00 Mountain Time, Denver -281: GMT-07:00 Arizona -240: GMT-06:00 Central America, Central Time, Mexico City, Saskatchewan

		<p>-200: GMT-05:00 Eastern Time, New York, Toronto</p> <p>-201: GMT-05:00 Bogota, Lima, Quito, Indiana</p> <p>-160: GMT-04:00 Atlantic Time, Canada, Caracas, La Paz, Santiago</p> <p>-140: GMT-03:30 Newfoundland</p> <p>-120: GMT-03:00 Brasilia, Buenos Aires, Georgetown, Greenland</p> <p>-80: GMT-02:00 Mid-Atlantic</p> <p>-40: GMT-01:00 Azores, Cape_Verde_IS.</p> <p>0: GMT Casablanca, Greenwich Mean Time: Dublin, Edinburgh, Lisbon, London</p> <p>40: GMT 01:00 Amsterdam, Berlin, Rome, Stockholm, Vienna, Madrid, Paris</p> <p>41: GMT 01:00 Warsaw, Budapest, Bern</p> <p>80: GMT 02:00 Athens, Helsinki, Istanbul, Riga</p> <p>81: GMT 02:00 Cairo</p> <p>82: GMT 02:00 Lebanon, Minsk</p> <p>83: GMT 02:00 Israel</p> <p>120: GMT 03:00 Baghdad, Kuwait, Riyadh, Moscow, St. Petersburg, Nairobi</p> <p>121: GMT 03:00 Iraq</p> <p>140: GMT 03:30 Tehran</p> <p>160: GMT 04:00 Abu Dhabi, Muscat, Baku, Tbilisi, Yerevan</p> <p>180: GMT 04:30 Kabul</p> <p>200: GMT 05:00 Ekaterinburg, Islamabad, Karachi, Tashkent</p> <p>220: GMT 05:30 Calcutta, Chennai, Mumbai, New Delhi</p> <p>230: GMT 05:45 Kathmandu</p> <p>240: GMT 06:00 Almaty, Novosibirsk, Astana, Dhaka, Sri Jayawardenepura</p> <p>260: GMT 06:30 Rangoon</p> <p>280: GMT 07:00 Bangkok, Hanoi, Jakarta, Krasnoyarsk</p>
--	--	--

			<p>320: GMT 08:00 Beijing, Chongqing, Hong Kong, Kuala Lumpur, Singapore, Taipei</p> <p>360: GMT 09:00 Osaka, Sapporo, Tokyo, Seoul, Yakutsk</p> <p>380: GMT 09:30 Adelaide, Darwin</p> <p>400: GMT 10:00 Brisbane, Canberra, Melbourne, Sydney, Guam, Vladivostok</p> <p>440: GMT 11:00 Magadan, Solomon Is., New Caledonia</p> <p>480: GMT 12:00 Auckland, Wellington, Fiji, Kamchatka, Marshall Is.</p> <p>520: GMT 13:00 Nuku'Alofa</p>
daylight_enable	<boolean>	6/6	enable automatic daylight saving to time zone
daylight_dstactual mode	<boolean>	6/7	check if current time is under daylight saving time.
daylight_auto_begin time	string[19]	6/7	display the current daylight saving begin time. (product dependent)
daylight_auto_end time	string[19]	6/7	display the current daylight saving end time. (product dependent)
updateinterval	0, 3600, 86400, 604800, 2592000	6/6	0 to Disable automatic time adjustment, otherwise, it means the seconds between NTP automatic update interval.
restore	0, <positive integer>	7/6	Restore the system parameters to default value after <value> seconds.
reset	0, <positive integer>	7/6	Restart the server after <value> seconds if <value> is non-negative.
restoreexceptnet	<Any value>	7/6	Restore the system parameters to default value except (ipaddress, subnet, router, dns1, dns2, pppoe). This command can cooperate with other "restoreexceptXYZ" commands. When cooperating with others, the system

			parameters will be restored to default value except a union of combined results.
restoreexceptdst	<Any value>	7/6	Restore the system parameters to default value except all daylight saving time settings. This command can cooperate with other "restoreexceptXYZ" commands. When cooperating with others, the system parameters will be restored to default value except a union of combined results.
restoreexceptlang	<Any Value>	7/6	Restore the system parameters to default value except custom language file user uploaded. This command can cooperate with other "restoreexceptXYZ" commands. When cooperating with others, the system parameters will be restored to default value except a union of combined results.

SubGroup of **system: info** (The fields in this group are unchangeable.)

NAME	VALUE	SECURITY (get/set)	DESCRIPTION
modelname	string[40]	0/7	Internal model name of server (eg. IP7139)
extendedmodelname	string[40]	0/7	ODM specific model name of server (eg. DCS-5610). If it is not ODM case, this field will be equal to "modelname"
serialnumber	<mac address>	0/7	12 characters mac address without hyphen connected
firmwareversion	string[40]	0/7	The version of firmware, including model, company, and version number in the format <MODEL-BRAND-VERSION>
language_count	<integer>	0/7	number of webpage language available on the server
language_i<0~(count-1)>	string[16]	0/7	Available language lists
customlanguage_maxcount	<integer>	0/7	Maximum number of custom language supported on the server
customlanguage_count	<integer>	0/7	Number of custom language which has been uploaded to the server

customlanguage_i<0~(max count-1)>	string	0/7	Custom language name
-----------------------------------	--------	-----	----------------------

Group: **status**

NAME	VALUE	SECURITY (get/set)	DESCRIPTION
di_i<0~(ndi-1)>	<boolean>	1/7	0 => Inactive, normal 1 => Active, triggered
do_i<0~ndi-1)>	<boolean>	1/7	0 => Inactive, normal 1 => Active, triggered
daynight	day, night	7/7	The day/night status judge by light sensor
onlinenum_rtsp	integer	6/7	current RTSP connection numbers
onlinenum_httppush	integer	6/7	current HTTP push server connection numbers
eth_i0	string	1/99	The connection information of ethernet

Group: **di_i<0~(ndi-1)>** (*capability.ndi > 0*)

NAME	VALUE	SECURITY (get/set)	DESCRIPTION
normalstate	high, low	1/1	indicate whether open circuit or closed circuit represents inactive status

Group: **do_i<0~(ndo-1)>** (*capability.ndo > 0*)

NAME	VALUE	SECURITY (get/set)	DESCRIPTION
normalstate	open, grounded	1/1	indicate whether open circuit or closed circuit represents inactive status

Group: **security**

NAME	VALUE	SECURITY (get/set)	DESCRIPTION
privilege_do	view, operator, admin	6/6	Indicate which privilege and above can control digital output
privilege_camctrl	view, operator, admin	6/6	Indicate which privilege and above can control PTZ
user_i0_name	string[64]	6/7	User's name of root
user_j<1~20>_name	string[64]	6/7	User's name
user_i0_pass	password[64]	6/6	root's password

user_i<1~20>_pass	password[64]	7/6	User's password
user_i0_privilege	viewer, operator, admin	6/7	root's privilege
user_i<1~20>_ privilege	viewer, operator, admin	6/6	User's privilege.

Group: **network**

NAME	VALUE	SECURITY (get/set)	DESCRIPTION
type	lan, pppoe	6/6	Network connection type
resetip	<boolean>	6/6	1 => get ipaddress, subnet, router, dns1, dns2 from DHCP server at next reboot 0 => use preset ipaddress, subnet, router, dns1, and dns2
ipaddress	<ip address>	6/6	IP address of server
subnet	<ip address>	6/6	subnet mask
router	<ip address>	6/6	default gateway
dns1	<ip address>	6/6	primary DNS server
dns2	<ip address>	6/6	secondary DNS server
wins1	<ip address>	6/6	primary WINS server
wins2	<ip address>	6/6	secondary WINS server

Subgroup of **network: ieee8021x**

NAME	VALUE	SECURITY (get/set)	DESCRIPTION
enable	<boolean>	6/6	Enable/disable IEEE 802.1x
eapmethod	eap-peap, eap-tls	6/6	Selected EAP method
identity_peap	String[64]	6/6	PEAP identity
identity_tls	String[64]	6/6	TLS identity
password	String[254]	6/6	Password for TLS
privatekeypassword	String[254]	6/6	Password for PEAP
ca_exist	<boolean>	6/6	CA installed flag
ca_time	<integer>	6/7	CA installed time. Represented in EPOCH
ca_size	<integer>	6/7	CA file size (in bytes)

certificate_exist	<boolean>	6/6	Certificate installed flag (for TLS)
certificate_time	<integer>	6/7	Certificate installed time. Represented in EPOCH
certificate_size	<integer>	6/7	Certificate file size (in bytes)
privatekey_exist	<boolean>	6/6	Private key installed flag (for TLS)
privatekey_time	<integer>	6/7	Private key installed time. Represented in EPOCH
privatekey_size	<integer>	6/7	Private key file size (in bytes)

Subgroup of **network: qos**

NAME	VALUE	SECURITY (get/set)	DESCRIPTION
cos_enable	<boolean>	6/6	Enable/disable CoS (IEEE 802.1p)
cos_vlanid	1~4095	6/6	VLAN ID
cos_video	0~7	6/6	Video channel for CoS
cos_audio	0~7	6/6	Audio channel for CoS
cos_eventalarm	0~7	6/6	Event/alarm channel for CoS
cos_management	0~7	6/6	Management channel for CoS
dscp_enable	<boolean>	6/6	Enable/disable DSCP
dscp_video	0~7	6/6	Video channel for DSCP
dscp_audio	0~7	6/6	Audio channel for DSCP
dscp_eventalarm	0~7	6/6	Event/alarm channel for DSCP
dscp_management	0~7	6/6	Management channel for DSCP

Subgroup of **network: ipv6**

NAME	VALUE	SECURITY (get/set)	DESCRIPTION
enable	<boolean>	6/6	Enable IPv6
addonipaddress	<ip address>	6/6	IPv6 IP address
addonprefixlen	0~128	6/6	IPv6 prefix length
addonrouter	<ip address>	6/6	IPv6 router address
addondns	<ip address>	6/6	IPv6 DNS address
allowoptional	<boolean>	6/6	Allow Manually setup the IP address setting

Subgroup of **network: ftp**

NAME	VALUE	SECURITY (get/set)	DESCRIPTION
port	21, 1025~65535	6/6	local ftp server port

Subgroup of **network: http**

NAME	VALUE	SECURITY (get/set)	DESCRIPTION
port	80, 1025 ~ 65535	6/6	HTTP port
alternateport	1025~65535	6/6	Alternative HTTP port
authmode	basic, digest	1/6	HTTP authentication mode
s0_accessname	string[32]	1/6	Http server push access name for stream 1 (capability.protocol.spush_mjpeg =1 and video.stream.count>0)
s1_accessname	string[32]	1/6	Http server push access name for stream 2 (capability.protocol.spush_mjpeg =1 and video.stream.count>1)
s2_accessname	string[32]	1/6	Http server push access name for stream 3 (capability.protocol.spush_mjpeg =1 and video.stream.count>2)
s3_accessname	string[32]	1/6	Http server push access name for stream 4 (capability.protocol.spush_mjpeg =1 and video.stream.count>3)
s4_accessname	string[32]	1/6	Http server push access name for stream 5 (capability.protocol.spush_mjpeg =1 and video.stream.count>4)
anonymousviewing	<boolean>	1/6	Enable anonymous streaming viewing.

Subgroup of **network: https**

NAME	VALUE	SECURITY (get/set)	DESCRIPTION
port	443, 1025 ~ 65535	6/6	HTTPS port

Subgroup of **network: rtsp**

NAME	VALUE	SECURITY (get/set)	DESCRIPTION
port	554, 1025 ~ 65535	1/6	RTSP port (capability.protocol.rtsp=1)
anonymousviewing	<boolean>	1/6	Enable anonymous streaming viewing.
authmode	disable, basic, digest	1/6	RTSP authentication mode (capability.protocol.rtsp=1)

s0_accessname	string[3b;42]	1/6	RTSP access name for stream1 (capability.protocol.rtsp=1 and video.stream.count>0)
s1_accessname	string[32]	1/6	RTSP access name for stream2 (capability.protocol.rtsp=1 and video.stream.count>1)
s2_accessname	string[32]	1/6	RTSP access name for stream3 (capability.protocol.rtsp=1 and video.stream.count>2)
s3_accessname	string[32]	1/6	RTSP access name for stream4 (capability.protocol.rtsp=1 and video.stream.count>3)
S4_accessname	string[32]	1/6	RTSP access name for stream5 (capability.protocol.rtsp=1 and video.stream.count>4)
s0_audiotrack	<integer>	6/6	The current audio track for stream1. -1 => audio mute
s1_audiotrack	<integer>	6/6	The current audio track for stream2. -1 => audio mute

Subgroup of **rtsp_s<0~(n-1)>**: **multicast**, n is stream count (**capability.protocol.rtp.multicast=1**)

NAME	VALUE	SECURITY (get/set)	DESCRIPTION
alwaysmulticast	<boolean>	4/4	Enable always multicast
ipaddress	<ip address>	4/4	Multicast IP address
videoport	1025 ~ 65535	4/4	Multicast video port
audioport	1025 ~ 65535	4/4	Multicast audio port
tll	1 ~ 255	4/4	Mutlicast time to live value

Subgroup of **network**: **sip**

NAME	VALUE	SECURITY (get/set)	DESCRIPTION
port	554, 1025 ~ 65535	6/6	SIP port (capability.protocol.sip=1)

Subgroup of **network: rtp**

NAME	VALUE	SECURITY (get/set)	DESCRIPTION
videoport	1025 ~ 65535	6/6	video channel port for RTP (capability.protocol.rtp_unicast=1)
audioport	1025 ~ 65535	6/6	audio channel port for RTP (capability.protocol.rtp_unicast=1)

Subgroup of **network: pppoe**

NAME	VALUE	SECURITY (get/set)	DESCRIPTION
user	string[128]	6/6	PPPoE account user name
pass	password[64]	6/6	PPPoE account password

Group: **ipfilter**

NAME	VALUE	SECURITY (get/set)	DESCRIPTION
enable	<boolean>	6/6	Enable or disable ipfilter settings
admin_enable	<boolean>	6/6	Enable or disable the function always allow the admin IP address to access this device
admin_ip	1.0.0.0 ~ 255.255.255.255	6/6	Always allow this IP connect to camera when admin_enable=1
maxconnection	0~10	6/6	Maximum number of concurrent streaming connection(s) limit
allow_i<0~9>_start	1.0.0.0 ~ 255.255.255.255	6/6	Allowed starting IP address for RTSP connection
allow_i<0~9>_end	1.0.0.0 ~ 255.255.255.255	6/6	Allowed ending IP address for RTSP connection
deny_i<0~9>_start	1.0.0.0 ~ 255.255.255.255	6/6	Denied starting IP address for RTSP connection
deny_i<0~9>_end	1.0.0.0 ~ 255.255.255.255	6/6	Denied ending IP address for RTSP connection
ipv6_allow_i<0~9>_start	<ip address>	6/6	Allowed IPv6 starting IP address for RTSP connection
ipv6_allow_i<0~9>_end	<ip address>	6/6	Allowed IPv6 ending IP address for RTSP connection
ipv6_deny_i<0~9>_start	<ip address>	6/6	Denied IPv6 starting IP address for RTSP connection

ipv6_deny_i<0~9>_ end	<ip address>	6/6	Denied IPv6 ending IP address for RTSP connection
--------------------------	--------------	-----	---

Group: **videoin**

NAME	VALUE	SECURITY (get/set)	DESCRIPTION
cmosfreq	50, 60	4/4	CMOS frequency (videoin.type=2) (product dependent)
whitebalance	<product dependent>	4/4	auto, auto white balance manual indoor, 3200K fluorescent, 5500K outdoor, > 5500K
atwbvalue1	0 ~ 9999999999	4/4	The auto white balance value.
atwbvalue2	0 ~ 9999999999	4/4	The auto white balance value.
exposurelevel	1 ~ 8	4/4	The target brightness adjust by exposure options 1: darkest 8: brightness
autoiris	<boolean>	4/4	Enable auto Iris (product dependent)
enableblc	<boolean>	4/4	Enable backlight compensation (product dependent)
agc	normal, max	4/4	Set auto gain control to normal level or MAX level (product dependent)

Group: **videoin_c<0~(n-1)>** for n channel products, m is stream number

NAME	VALUE	SECURITY (get/set)	DESCRIPTION
color	0, 1	4/4	0 => monochrome 1 => color
flip	<boolean>	4/4	flip the image
mirror	<boolean>	4/4	mirror the image
ptzstatus	<integer>	1/7	An 32-bits integer, each bit can be set separately as follows: Bit 0 => Support camera control

			<p>function 0(not support), 1(support)</p> <p>Bit 1 => Build-in or external camera. 0(external), 1(build-in)</p> <p>Bit 2 => Support pan operation. 0(not support), 1(support)</p> <p>Bit 3 => Support tilt operation. 0(not support), 1(support)</p> <p>Bit 4 => Support zoom operation. 0(not support), 1(support)</p> <p>Bit 5 => Support focus operation. 0(not support), 1(support)</p>
text	string[16]	1/4	enclosed caption
imprinttimestamp	<boolean>	4/4	Overlay time stamp on video
maxexposure	1~120	4/4	Maximum exposure time
options	quality, framerate	4/4	To customize video quality first or video frame rate first. (product dependent)
enablepreview	<boolean>	1/4	0: normal mode 1: preview mode (capability_nvideoinprofile > 0)
profile_i<0~(k-1)>_enable	<boolean>	4/4	Enable this profile (capability_nvideoinprofile > 0)
profile_i<0~(k-1)>_policy	day, night, schedule	4/4	When the condition match the policy, use this profile (capability_nvideoinprofile > 0)
profile_i<0~(k-1)>_begintime	hh:mm	4/4	If choose "schedule" mode as profile policy, the begin time of this profile when enabled (capability_nvideoinprofile > 0)
profile_i<0~(k-1)>_endtime	hh:mm	4/4	If choose "schedule" mode as profile policy, the end time of this profile when enabled (capability_nvideoinprofile > 0)
profile_i<0~(k-1)>_maxexposure	1~120	4/4	Maximum exposure time (capability_nvideoinprofile > 0)
profile_i<0~(k-1)>_enableblc	1~8	4/4	Enable backlight compensation
profile_i<0~(k-1)>_exposurelevel	1~8	4/4	The target brightness adjust by exposure options

			1: darkest 8: brightness (capability_nvideoinprofile > 0)
profile_i<0~(k-1)>_agc	0~2	4/4	Set auto gain control to: 0: 2X level 1: 4X level 2: 8X level (capability_nvideoinprofile > 0)
profile_i<0~(k-1)>_autoiris	<boolean>	4/4	Enable auto Iris (capability_nvideoinprofile > 0)
s<0~(m-1)>_codectype	mpeg4, mjpeg	4/4	video codec type
s<0~(m-1)>_resolution	176x144, 320x240, 640x480, 800x600, 1280x960, 1600x1200	4/4	Video resolution in pixel
s<0~(m-1)>_mpeg4_intra period	250, 500, 1000, 2000, 3000, 4000	4/4	The period of intra frame in milliseconds
s<0~(m-1)>_mpeg4_rate controlmode	cbr, vbr	4/4	cbr, constant bitrate vbr, fix quality
s<0~(m-1)>_mpeg4_quant	1~5, 99	4/4	quality of video when choosing vbr in "ratecontrolmode". 99 is customized manual input setting. 1 is worst quality and 5 is the best quality.
s<0~(m-1)>_mpeg4_qvalue	1~31	7/4	The specific quality parameter of mpeg4 encoder. 1 is best quality and 31 is the worst quality.
s<0~(m-1)>_mpeg4_bitrate	1000~400000 0	4/4	Set bit rate in bps when choose cbr in "ratecontrolmode"
s<0~(m-1)>_mpeg4_maxfra me	1~15 for quality mode 1~30 for frame rate mode	4/4	set maximum frame rate in fps (for MPEG-4)
s<0~(m-1)>_mjpeg_quant	1 ~ 5, 999	4/4	quality of jpeg video. 999 is customized manual input setting.

			1 is worst quality and 5 is the best quality.
s<0~(m-1)>_mjpeg_qvalue	10~200	7/4	The specific quality parameter of jpeg encoder. 10 is best quality and 200 is the worst quality.
s<0~(m-1)>_mjpeg_maxframe	1~25, 26~30 (only for NTSC or 60Hz CMOS)	4/4	set maximum frame rate in fps (for JPEG)
s<0~(m-1)>_forcei	1	7/6	Force I frame

Group: **videoinpreview**

NAME	VALUE	SECURITY (get/set)	DESCRIPTION
maxexposure	1~120	4/4	Maximum exposure time
exposurelevel	1 ~ 8	4/4	The target brightness adjust by exposure options 1: darkest 8: brightness
enableblc	<boolean>	4/4	Enable backlight compensation (product dependent)
agc	0~2	4/4	Set auto gain control to: 0: 2X level 1: 4X level 2: 8X level (product dependent)
autoiris	<boolean>	4/4	Enable auto Iris (product dependent)

Group: **audioin_c<0~(n-1)>** for n channel products (**capability.audioin>0**)

NAME	VALUE	SECURITY (get/set)	DESCRIPTION
source	micin, linein	4/4	micin => use external microphone input linein => use line input
mute	0, 1	4/4	Enable audio mute
gain	1~37	4/4	Gain of input
gain2	1~37	4/4	Gain of input
s<0~(m-1)>_codectype	aac4, gamr	4/4	set audio codec type for input
s<0~(m-1)>_aac4_bitrate	16000,	4/4	set AAC4 bitrate in bps

	32000, 48000, 64000, 96000, 128000		
s<0~(m-1)>_gamr_bitrate	4750, 5150, 5900, 6700, 7400, 7950, 10200, 12200	4/4	set AMR bitrate in bps

Group: **image_c<0~(n-1)>** for n channel products

NAME	VALUE	SECURITY (get/set)	DESCRIPTION
brightness	-5 ~ 5	4/4	Adjust brightness of image according to mode settings.
saturation	-5 ~ 5	4/4	Adjust saturation of image according to mode settings.
contrast	-5 ~ 5	4/4	Adjust contrast of image according to mode settings.
sharpness	-5 ~ 5	4/4	Adjust sharpness of image according to mode settings.
IBPE_edgeenable	<boolean>	4/4	Enable edge enhancement.
IBPE_edgestrength	1 ~ 128	4/4	Adjust edge enhancement strength. 1 is minimum and 128 is maximum.
IBPE_nrenable	<boolean>	4/4	Enable noise reduction.
IBPE_nrmode	1 ~ 3	4/4	Adjust noise reduction mode. 1 => DeGaussian 2 => DeImpulse 3 => DeGaussian + DeImpulse
IBPE_nrstrength	1 ~ 63	4/4	Adjust noise reduction strength. 1 is minimum and 63 is maximum.

Group: **imagepreview_c<0~(n-1)>** for n channel products

NAME	VALUE	SECURITY (get/set)	DESCRIPTION
brightness	-5 ~ 5	4/4	Preview of adjusting brightness of image according to mode settings.
saturation	-5 ~ 5	4/4	Preview of adjusting saturation of image according to mode settings.
contrast	-5 ~ 5	4/4	Preview of adjusting contrast of image according to mode settings.
sharpness	-5 ~ 5	4/4	Preview of adjusting sharpness of image according to mode settings.
IBPE_edgenable	<boolean>	4/4	Preview of adjusting enabling edge enhancement.
IBPE_edgestrength	1 ~ 128	4/4	Preview of adjusting edge enhancement strength. 1 is minimum and 128 is maximum.
IBPE_nrenable	<boolean>	4/4	Preview of adjusting enabling noise reduction.
IBPE_nrmode	1 ~ 3	4/4	Preview of adjusting noise reduction mode. 1 => DeGaussian 2 => DeImpulse 3 => DeGaussian + DeImpulse
IBPE_nrstrength	1 ~ 63	4/4	Preview of adjusting noise reduction strength. 1 is minimum and 63 is maximum.
videoin_whitebalance	auto, manual	4/4	Preview of adjusting white balance of image according to mode settings
videoin_restoreatwb	0, 1~	4/4	Restore of adjusting white balance of image according to mode settings

Group: **timeshift, c** for n channel products, m is stream number

NAME	VALUE	SECURITY (get/set)	DESCRIPTION
enable	<boolean>	4/4	Enable time shift streaming.
c<0~(n-1)>_s<0~(m-1)>_allow	<boolean>	4/4	Enable time shift streaming for specific stream. (product dependent)

Group: **motion_c<0~(n-1)>** for n channel product

NAME	VALUE	SECURITY (get/set)	DESCRIPTION
enable	<boolean>	4/4	enable motion detection
win_i<0~2>_enable	<boolean>	4/4	enable motion window 1~3
win_i <0~2>_name	string[14]	4/4	name of motion window 1~3
win_i <0~2>_left	0 ~ 320	4/4	Left coordinate of window position.
win_i <0~2>_top	0 ~ 240	4/4	Top coordinate of window position.
win_i <0~2>_width	0 ~ 320	4/4	Width of motion detection window.
win_i<0~2>_height	0 ~ 240	4/4	Height of motion detection window.
win_i<0~2>_objsize	0 ~ 100	4/4	Percent of motion detection window.
win_i<0~2>_sensitivity	0 ~ 100	4/4	Sensitivity of motion detection window.

Group: **motion_c<0~(n-1)>_profile_i<0~(m-1)>** for n channel, m motion profile product

(**capability_nmotionprofile > 0**)

NAME	VALUE	SECURITY (get/set)	DESCRIPTION
enable	<boolean>	4/4	enable motion detection
policy	day, night, schedule	4/4	When the condition match the policy, use this profile
begintime	hh:mm	4/4	If choose "schedule" mode as profile policy, the begin time of this profile when enabled
endtime	hh:mm	4/4	If choose "schedule" mode as profile policy, the end time of this profile when enabled
win_i<0~2>_enable	<boolean>	4/4	enable motion window 1~3
win_i <0~2>_name	string[14]	4/4	name of motion window 1~3
win_i <0~2>_left	0 ~ 320	4/4	Left coordinate of window position.
win_i <0~2>_top	0 ~ 240	4/4	Top coordinate of window position.
win_i <0~2>_width	0 ~ 320	4/4	Width of motion detection window.
win_i<0~2>_height	0 ~ 240	4/4	Height of motion detection window.
win_i<0~2>_objsize	0 ~ 100	4/4	Percent of motion detection window.
win_i<0~2>_sensitivity	0 ~ 100	4/4	Sensitivity of motion detection window.

Group: tampering_c<0~(n-1)> for n channel,

NAME	VALUE	DEFAULT	SECURITY (get/set)	DESCRIPTION
enable	<boolean>	0	4/4	Enable or disable camera tampering detection
threshold	0 ~ 255	32	4/4	The sensitivity to judge if camera has been tampered 0: lowest sensitivity 255: highest sensitivity
duration	10 ~ 600	10	4/4	Judge camera has been tampered if exceeding this duration

Group: **ddns**

NAME	VALUE	SECURITY (get/set)	DESCRIPTION
enable	<boolean>	6/6	Enable or disable the dynamic dns.
provider	Safe100, DyndnsDynamic, DyndnsCustom, TZO, DHS, DynInterfree, CustomSafe100	6/6	Safe100 => safe100.net DyndnsDynamic => dyndns.org (dynamic) DyndnsCustom => dyndns.org (custom) TZO => tzo.com DHS => dhs.org DynInterfree => dyn-interfree.it CustomSafe100 => Custom server using safe100 method
<provider>_hostname	string[128]	6/6	Your dynamic hostname.
<provider>_usernameemail	string[64]	6/6	Your user or email to login ddns service provider
<provider>_passwordkey	string[64]	6/6	Your password or key to login ddns service provider
<provider>_servername	string[128]	6/6	The server name for safe100. (This field only exists for provider is customsaf100)

Group: **upnpresentation**

NAME	VALUE	SECURITY (get/set)	DESCRIPTION
enable	<boolean>	6/6	Enable or disable the UPNP presentation service.

Group: **upnpportforwarding**

NAME	VALUE	SECURITY (get/set)	DESCRIPTION
enable	<boolean>	6/6	Enable or disable the UPNP port forwarding service.
upnpnatstatus	0~3	6/7	The status of UpnP port forwarding, used internally. 0 is OK, 1 is FAIL, 2 is no IGD router, 3 is no need to do port forwarding

Group: **syslog**

NAME	VALUE	SECURITY (get/set)	DESCRIPTION
enableremotelog	<boolean>	6/6	enable remote log
serverip	<IP address>	6/6	Log server IP address
serverport	514, 1025~65535	6/6	Server port used for log
level	0~7	6/6	The levels to distinguish the importance of information. 0: LOG_EMERG 1: LOG_ALERT 2: LOG_CRIT 3: LOG_ERR 4: LOG_WARNING 5: LOG_NOTICE 6: LOG_INFO 7: LOG_DEBUG

Group: **camctrl_c<0~(n-1)>** for n channel product (**capability.ptzenabled**)

NAME	VALUE	SECURITY (get/set)	DESCRIPTION
panspeed	-5 ~ 5	1/4	Pan speed
tiltspeed	-5 ~ 5	1/4	Tilt speed
zoomspeed	-5 ~ 5	1/4	Zoom speed
focusspeed	-5 ~ 5	1/4	Auto focus speed
patrolseq	0 ~ 64	1/4	Patrol sequence
patroldwelling	0 ~ 128	1/4	Patrol dwelling time
preset_i<0~19>_name	string[40]	1/4	The name of preset location
preset_i<0~19>_dwelling	0 ~ 255	1/4	The dwelling time of each preset location

uart	0 ~ (m-1), m is uart count	1/4	select correspond uart (capability.nuart>0)
cameraid	0~255	1/4	Camera ID to control external PTZ camera
isptz	0 ~ 2	1/7	0: disable PTZ commands. 1: enable PTZ commands with PTZ driver. 2: enable PTZ commands with UART tunnel.
disablemdonptz	<boolean>	1/4	disable motion detection on PTZ operation

Group: **uart** (capability.nuart>0) (product dependent)

NAME	VALUE	SECURITY (get/set)	DESCRIPTION
ptzdrivers_i<0~19, 127>_name	string[40]	1/4	The name of the PTZ driver
ptzdrivers_i<0~19, 127>_location	string[128]	1/4	The full path of the PTZ driver
update	1	7/4	update the list of built-in external PTZ drivers
enablehttptunnel	<boolean>	4/4	Enable HTTP tunnel channel to control UART

Group: **uart_i<0~(n-1)>** n is uart port count (capability.nuart>0)

NAME	VALUE	SECURITY (get/set)	DESCRIPTION
baudrate	110,300,600,120 0,2400,3600,480 0,7200,9600,192 00,38400,57600, 115200	4/4	set baud rate of COM port
databit	5,6,7,8	4/4	data bits in a character frame
paritybit	none, odd, even	4/4	For error checking
stopbit	1,2	4/4	1 2-1.5 , data bit is 5 2-2
uartmode	rs485, rs232	4/4	rs485 or rs232
customdrvcmd_i<0~9>	string[128]	1/4	PTZ command for custom camera.

speedlink_i<0~4>_name	string[40]	1/4	Additional PTZ command name
speedlink_i<0~4>_cmd	string[128]	1/4	Additional PTZ command list
updatecustomdrvcmd	1	7/4	set this flag to true to apply change of custom command configuration
updatespeedlinkcmd	1	7/4	set this flag to true to apply change of additional PTZ command configuration
ptzdriver	0~19, 127 (custom), 128 (no driver)	4/4	which PTZ driver is used by this COM port

Group: **snmp** (capability.snmp) (product dependent)

NAME	VALUE	SECURITY (get/set)	DESCRIPTION
versions	1 ~ 3	6/6	SNMP version to use.
rocomm	string[14]	6/6	V1, V2c Read only community.
rwcomm	string[14]	6/6	V1, V2c Read write community.
adminauthtype	0 ~ 2	6/6	Authority type for root authentication.
admindpvcy	string[64]	6/6	Root data encryption key.
enableadpvcy	<boolean>	6/6	Enable root data encryption key.
userauthtype	0 ~ 2	6/6	User authority authentication.
userdpvcy	string[64]	6/6	User data encryption key.
enableudpvcy	<boolean>	6/6	Enable user data encryption key.
trapserver	<ip address>, <domain name> [128]	6/6	Trap server
trapcomm	string[14]	6/6	Trap community
objectid	string[40]	6/6	Object ID

Group: **layout** (product dependent)

NAME	VALUE	SECURITY (get/set)	DESCRIPTION
logo_default	<boolean>	1/6	0 => Custom logo 1 => Default logo

logo_link	string[40]	1/6	Hyperlink of the logo
theme_option	1~4	1/6	1~3: One of the default themes 4: Custom definition
theme_color_font	string[7]	1/6	Font color
theme_color_configfont	string[7]	1/6	Font color of configuration area
theme_color_titlefont	string[7]	1/6	Font color of video title
theme_color_controlbackground	string[7]	1/6	Background color of control area
theme_color_configbackground	string[7]	1/6	Background color of configuration area
theme_color_videobackground	string[7]	1/6	Background color of video area
theme_color_case	string[7]	1/6	Frame color

Group: **privacymask_c<0~(n-1)>** for n channel product

NAME	VALUE	SECURITY (get/set)	DESCRIPTION
enable	<boolean>	4/4	Enable the privacy mask
win_i<0~4>_enable	<boolean>	4/4	Enable the privacy mask window
win_i<0~4>_name	string[14]	4/4	The name of privacy mask window
win_i<0~4>_left	0 ~ 320/352	4/4	Left coordinate of window position.
win_i<0~4>_top	0 ~ 240/288	4/4	Top coordinate of window position.
win_i<0~4>_width	0 ~ 320/352	4/4	Width of privacy mask window
win_i<0~4>_height	0 ~ 240/288	4/4	Height of privacy mask window
win_i<0~4>_color	0 ~ 13	4/4	Color of privacy mask window

Group: **capability**

NAME	VALUE	SECURITY (get/set)	DESCRIPTION
api_httpversion	0200a	0/7	The HTTP API version.
bootuptime	<positive integer>	0/7	The server bootup time
nir	0, <positive integer>	0/7	number of IR interface
ndi	0, <positive integer>	0/7	number of digital input

ndo	0, <positive integer>	0/7	number of digital output
naudioin	0, <positive integer>	0/7	number of audio input
naudioout	0, <positive integer>	0/7	number of audio output
nvideoin	<positive integer>	0/7	number of video input
nmediastream	<positive integer>	0/7	number of media stream per channel
nvideosetting	<positive integer>	0/7	number of video settings per channel
naudiosetting	<positive integer>	0/7	number of audio settings per channel
nuart	0, <positive integer>	0/7	number of UART interface
nvideoinprofile	0, <positive integer>	0/7	number of sensor profiles
nmotionprofile	0, <positive integer>	0/7	number of motion profiles
ptzenabled	< positive integer >	0/7	<p>An 32-bits integer, each bit can be set separately as follows:</p> <p>Bit 0 => Support camera control function 0(not support), 1(support)</p> <p>Bit 1 => Build-in or external camera. 0(external), 1(build-in)</p> <p>Bit 2 => Support pan operation. 0(not support), 1(support)</p> <p>Bit 3 => Support tilt operation. 0(not support), 1(support)</p> <p>Bit 4 => Support zoom operation. 0(not support), 1(support)</p> <p>Bit 5 => Support focus operation. 0(not support), 1(support)</p> <p>Bit 6 => Support iris operation. 0(not support), 1(support)</p> <p>Bit 7 => External or build-in PT. 0(build-in), 1(external)</p> <p>Bit 8 => Invalidate bit 1 ~ 7. 0(bit 1 ~ 7 are valid), 1(bit 1 ~ 7 are invalid)</p>

			Bit 9 => Reserved bit; Invalidate lens_pan, Lens_tilt, lens_zoon, lens_focus, len_iris. 0(fields are valid), 1(fields are invalid)
eptz	<positive integer>	0/7	A 32-bit integer, each bit can be set separately as follows: Bit 0 => stream 1 supports ePTZ or not. Bit 1 => stream 2 supports ePTZ or not. The rest may be deduced by analogy
protocol_https	<boolean>	0/7	indicate whether to support http over SSL
protocol_rtsp	<boolean>	0/7	indicate whether to support rtsp
protocol_sip	<boolean>	0/7	indicate whether to support sip
protocol_maxconnection	<positive integer>	0/7	The maximum allowed simultaneous connections
protocol_rtp_multicast_scalable	<boolean>	0/7	indicate whether to support scalable multicast
protocol_rtp_multicast_backchannel	<boolean>	0/7	indicate whether to support backchannel multicast
protocol_rtp_tcp	<boolean>	0/7	indicate whether to support rtp over tcp
protocol_rtp_http	<boolean>	0/7	indicate whether to support rtp over http
protocol_spush_motion_jpeg	<boolean>	0/7	indicate whether to support server push motion jpeg
protocol_snmp	<boolean>	0/7	indicate whether to support snmp
protocol_ipv6	<boolean>	0/7	indicate whether to support ipv6
videoin_type	0, 1, 2	0/7	0 => Interlaced CCD 1 => Progressive CCD 2 => CMOS
videoin_resolution	<a list of the available resolution separates by comma)	0/7	available resolutions list
videoin_maxframe rate	<a list of the available max frame rate separates by comma>	0/7	available framerate at the videoin_resolution list index

videoin_codec	<a list of the available codec types separators by comma)	0/7	available codec list
videoout_codec	<a list of the available codec types separators by comma)	0/7	available codec list
audio_aec	<boolean>	0/7	indicate whether to support acoustic echo cancellation
audio_extmic	<boolean>	0/7	indicate whether to support external microphone input
audio_linein	<boolean>	0/7	indicate whether to support external line input
audio_lineout	<boolean>	0/7	indicate whether to support line output
audio_headphone out	<boolean>	0/7	indicate whether to support headphone output
audioin_codec	<a list of the available codec types separators by comma)	0/7	available codec list
audioout_codec	<a list of the available codec types separators by comma)	0/7	available codec list
uart_httptunnel	<boolean>	0/7	Indicate whether to support the http tunnel for uart transfer
camctrl_httptunnel	<boolean>	0/7	Indicate whether to support the http tunnel for camera control
camctrl_privilege	<boolean>	0/7	Indicate whether to support "Manage Privilege" of PTZ control in Security page
transmission_mode	Tx, Rx, Both	0/7	Indicate what kind of transmission mode the machine used. TX: server, Rx: receiver box, Both: DVR?.
network_wire	<boolean>	0/7	Indicate whether to support the Ethernet
network_wireless	<boolean>	0/7	Indicate whether to support the wireless
wireless_802dot11b	<boolean>	0/7	Indicate whether to support the wireless 802.11b+

wireless_802dot11g	<boolean>	0/7	Indicate whether to support the wireless 802.11g
wireless_encrypt_wep	<boolean>	0/7	Indicate whether to support the wireless WEP
wireless_encrypt_wpa	<boolean>	0/7	Indicate whether to support the wireless WPA
wireless_encrypt_wpa2	<boolean>	0/7	Indicate whether to support the wireless WPA2
derivative_brand	<boolean>	0/7	Indicate whether to support upgrade function for the derivative brand. For example, if the value is true, the VVTK product can be upgraded to VVXX. (TCVV->TCXX is excepted)
evctrlchannel	<boolean>	0/7	Indicate whether to support the http tunnel for event/control transfer
joystick	<boolean>	0/7	Indicate whether to support the joystick control
nanystream	<positive integer>	0/7	number of any media stream per channel

Group: **event_customtaskfile**

PARAMETER	VALUE	SECURITY (get/set)	DESCRIPTION
_i<0~2>_name	string[40]	6/6	Name of custom event task file
_i<0~2>_date	string[20]	6/6	Date of custom event task file
_i<0~2>_time	string[20]	6/6	Time of custom event task file

Group: **event_i<0~2>**

PARAMETER	VALUE	SECURITY (get/set)	DESCRIPTION
name	string[40]	6/6	The identification of this entry
enable	0, 1	6/6	To enable or disable this event.
priority	0, 1, 2	6/6	Indicate the priority of this event. "0" indicates low priority. "1" indicates normal priority. "2" indicates high priority.
delay	1~999	6/6	Delay seconds before detect next event.

trigger	boot, di, motion, seq, visignal	6/6	Indicate the trigger condition. "boot" indicates system boot. "di" indicates digital input. "motion" indicates video motion detection. "seq" indicates periodic condition. "visignal" indicates video input signal loss
di	<integer>	6/6	Indicate which di detected. This field is required when trigger condition is "di". One bit represents one digital input. The LSB indicates DI 0.
mdwin	<integer>	6/6	Indicate which motion detection windows detected. This field is required when trigger condition is "md". One bit represents one window. The LSB indicates the 1 st window. For example, to detect the 1 st and 3 rd windows, set mdwin as 5.
inter	1~999	6/6	Interval of period snapshot in minute. This field is used when trigger condition is "seq".
weekday	<interger>	6/6	Indicate which weekday is scheduled. One bit represents one weekday. The bit0 (LSB) indicates Saturday. The bit1 indicates Friday. The bit2 indicates Thursday. The bit3 indicates Wednesday. The bit4 indicates Tuesday. The bit5 indicates Monday. The bit6 indicates Sunday. For example, to detect events on Friday and Sunday, set weekday as 66.
begintime	hh:mm	6/6	Begin time of weekly schedule.
endtime	hh:mm	6/6	End time of weekly schedule. (00:00 ~ 24:00 means always.)
lowlightcondition	0, 1	6/6	Turn on IR led in some condition: 0: all conditions 1: low light condition

action_do_i<0~(ndo-1)>_enable	0, 1	6/6	To enable or disable trigger digital output.
action_do_i<0~(ndo-1)>_duration	1~999	6/6	The duration of digital output is triggered in seconds.
action_cf_enable	0, 1	6/6	To enable put media on CF.
action_cf_folder	string[128]	6/6	The path to store media.
action_cf_media	NULL, 0~4	6/6	The index of attached media.
action_cf_datefolder	<boolean>	6/6	Enable or disable create folders by date time and hour automatically
action_server_i<0~4>_enable	0, 1	6/6	To enable or disable this server action. The default value is 0.
action_server_i<0~4>_media	NULL, 0~4	6/6	The index of attached media.
action_server_i<0~4>_datefolder	<boolean>	6/6	Enable or disable create folders by date time and hour automatically

Group: **server_i<0~4>**

PARAMETER	VALUE	SECURITY (get/set)	DESCRIPTION
name	string[40]	6/6	The identification of this entry
type	email, ftp, http, ns	6/6	Indicate the server type. "email" is email server. "ftp" is ftp server. "http" is http server. "ns" is network storage.
http_url	string[128]	6/6	The url of http server to upload.
http_username	string[64]	6/6	The username to login in the server.
http_passwd	string[64]	6/6	The password of the user.
ftp_address	string[128]	6/6	The ftp server address
ftp_username	string[64]	6/6	The username to login in the server.
ftp_passwd	string[64]	6/6	The password of the user.
ftp_port	0~65535	6/6	The port to connect the server.
ftp_location	string[128]	6/6	The location to upload or store the media.

ftp_passive	0, 1	6/6	To enable or disable the passive mode. 0 is to disable the passive mode. 1 is to enable the passive mode.
email_address	string[128]	6/6	The email server address
email_sslmode	<boolean>	6/6	To enable or disable the SSL mode 0 is to disable the SSL mode 1 is to enable the SSL mode
email_username	string[64]	6/6	The username to login in the server.
email_httpsmode	0, 1	6/6	Enable support SSL
email_port	0~65535	6/6	The port to connect the server.
email_passwd	string[64]	6/6	The password of the user.
email_senderemail	string[128]	6/6	The email address of sender.
email_recipientemail	string[128]	6/6	The email address of recipient.
ns_location	string[128]	6/6	The location to upload or store the media.
ns_username	string[64]	6/6	The username to login in the server.
ns_passwd	string[64]	6/6	The password of the user.
ns_workgroup	string[64]	6/6	The workgroup for network storage.

Group: **media_i<0~4>**(media_freespace is used internally.)

PARAMETER	VALUE	SECURITY (get/set)	DESCRIPTION
name	string[40]	6/6	The identification of this entry
type	snapshot, systemlog videoclip	6/6	The media type to send to the server or store by the server.
snapshot_source	<integer>	6/6	Indicate the source of media stream. 0 means the first stream. 1 means the second stream and etc. 2 means the third stream and etc. 3 means the fourth stream and etc.
snapshot_prefix	string[16]	6/6	Indicate the prefix of the filename.
snapshot_datesuffix	0, 1	6/6	To add date and time suffix to filename or not. 1 means to add date and time suffix. 0 means not to add it.
snapshot_preevent	0 ~ 7	6/6	It indicates the number of pre-event images.

snapshot_postevent	0 ~ 7	6/6	The number of post-event images.
videoclip_source	<integer>	6/6	Indicate the source of media stream. 0 means the first stream. 1 means the second stream and etc. 2 means the third stream and etc. 3 means the fourth stream and etc.
videoclip_prefix	string[16]	6/6	Indicate the prefix of the filename.
videoclip_preevent	0 ~ 9	6/6	It indicates the time of pre-event recording in seconds.
videoclip_maxduration	1 ~ 10	6/6	The time of maximum duration of one video clip in seconds.
videoclip_maxsize	50 ~ 1500	6/6	The maximum size of one video clip file in Kbytes.

Group: **recording_i**<0~1>

PARAMETER	VALUE	SECURITY (get/set)	DESCRIPTION
name	string[40]	6/6	The identification of this entry
enable	0, 1	6/6	To enable or disable this recoding.
priority	0, 1, 2	6/6	Indicate the priority of this recoding. "0" indicates low priority. "1" indicates normal priority. "2" indicates high priority.
source	<integer>	6/6	Indicate the source of media stream. 0 means the first stream. 1 means the second stream and etc. 2 means the third stream and etc. 3 means the fourth stream and etc.

weekday	<interger>	6/6	Indicate which weekday is scheduled. One bit represents one weekday. The bit0 (LSB) indicates Saturday. The bit1 indicates Friday. The bit2 indicates Thursday. The bit3 indicates Wednesday. The bit4 indicates Tuesday. The bit5 indicates Monday. The bit6 indicates Sunday. For example, to detect events on Friday and Sunday, set weekday as 66.
begintime	hh:mm	6/6	Begin time of weekly schedule.
endtime	hh:mm	6/6	End time of weekly schedule. (00:00~24:00 means always.)
prefix	string[16]	6/6	Indicate the prefix of the filename.
limitsize	0,1	6/6	0: Entire free space mechanism 1: Limit recording size mechanism
cyclesize	20~	6/6	The maximum size for cycle recording in Kbytes when choose limit recording size.
cyclic	0,1	6/6	0: Disable cyclic recording 1: Enable cyclic recording
notify	0,1	6/6	0: Disable recording notification 1: Enable recording notification
notifyserver	0~31	6/6	Indicate which notification server is scheduled. One bit represents one application server (server_i0~i4). The bit0 (LSB) indicates server_i0. The bit1 indicates server_i1. The bit2 indicates server_i2. The bit3 indicates server_i3. The bit4 indicates server_i4. For example, enable server_i0, server_i2 and server_i4 to be notification server. The notifyserver value is 21.
reserveamount	10~	6/6	The reserve amount in Mbytes when choose cyclic recording mechanism.

dest	cf, 0~4	6/6	The destination to store the recording data. "cf" means CF card. "0~4" means the index of network storage.
cffolder	string[128]	6/6	folder name.

Group: **path**

NAME	VALUE	SECURITY (get/set)	DESCRIPTION
encoder1_start	<boolean>	7/7	Specify the http push server is active for stream 1
encoder2_start	<boolean>	7/7	Specify the http push server is active for stream 2

Group: **https** (product dependent)

NAME	VALUE	SECURITY (get/set)	DESCRIPTION
connect	1025 ~ 65535	7/7	Specify the stunnel connect port
enable	<boolean>	6/6	To enable or disable this secure http
policy	<Boolean>	6/6	If the value is 1, it will force http connection redirect to https connection
method	auto, manual, install	6/6	auto => Create self-signed certificate automatically manual => Create self-signed certificate manually install => Create certificate request and install
status	-2 ~ 1	6/6	Specify the https status. -2=>invalid public key -1=>waiting for certificated 0=>not installed 1=>active
countryname	string[2]	6/6	country name in certificate information
stateorprovincename	string[128]	6/6	state or province name in in certificate information
localityname	string[128]	6/6	the locality name in certificate information
organizationname	string[64]	6/6	organization naem in certificate information
unit	string[32]	6/6	organizational unit name in certificate

			information
commonname	string[64]	6/6	common name in certificate information
validdays	0 ~ 9999	6/6	certificatation valid period

Group: **disk_i<0~(n-1)>** n is the total number of storage devices.

PARAMETER	VALUE	SECURITY (get/set)	DESCRIPTION
name	string[16]	6/6	Disk name.
cyclic_enabled	<boolean>	6/6	Enable cyclic storage method.
autocleanup_enabled	<boolean>	6/6	Enable automatic clean up method. Expired and not locked media files will be deleted.
autocleanup_maxage	<positive integer>	6/6	To specify the expired days for automatic clean up.

Group: **roi_c<0~(n-1)>** for n channel product, and m is the number of streams which support ROI.

PARAMETER	VALUE	SECURITY (get/set)	DESCRIPTION
s<0~(m-1)>_home	<coordinate>	6/6	ROI left-top corner coordinate.
s<0~(m-1)>_size	<window size>	6/6	ROI width and height.

Group: **eptz_c<0~(n-1)>** for n channel product.

PARAMETER	VALUE	SECURITY (get/set)	DESCRIPTION
osdzoom	<boolean>	1/4	Indicates multiple of zoom in is "on-screen display" or not
smooth	<boolean>	1/4	Indicates ePTZ is smooth or not.
tiltspeed	-5 ~ 5	1/7	Tilt speed (It should be set by eCamCtrl.cgi rather than by setparam.cgi.)
panspeed	-5 ~ 5	1/7	Pan speed (It should be set by eCamCtrl.cgi rather than by setparam.cgi.)
zoomspeed	-5 ~ 5	1/7	Zoom speed (It should be set by eCamCtrl.cgi rather than by setparam.cgi.)

autospeed	1 ~ 5	1/7	Auto pan/patrol speed (It should be set by eCamCtrl.cgi rather than by setparam.cgi.)
-----------	-------	-----	--

Group: **eptz_c<0~(n-1)>_s<0~(m-1)>** for n channel product. and m is the number of streams which support ePTZ.

PARAMETER	VALUE	SECURITY (get/set)	DESCRIPTION
patrolseq	string[120]	1/4	The indexes of patrol points, separated by “,”
patroldwelling	string[160]	1/4	The dwelling time of each patrol point, separated by “,”
i<0~19>_name	string[40]	1/7	Name of ePTZ preset. (It should be set by eCamCtrl.cgi rather than by setparam.cgi.)
i<0~19>_pos	<coordinate>	1/7	Left-top corner coordinate of the preset. (It should be set by eCamCtrl.cgi rather than by setparam.cgi.)
i<0~19>_size	<window size>	1/7	Width and height of the preset. (It should be set by eCamCtrl.cgi rather than by setparam.cgi.)

Drive the digital output

Note: This request requires the privilege of viewer.

Method: GET/POST

Syntax:

```
http://<servername>/cgi-bin/dido/setdo.cgi?do1=<state>[&do2=<state>]
[&do3=<state>][&do4=<state>][&return=<return page>]
```

Where state is 0, 1. “0” means inactive or normal state while “1” means active or triggered state.

PARAMETER	VALUE	DESCRIPTION
do<num>	0, 1	0 – inactive, normal state
		1 – active, triggered state
return	<return page>	Redirect to the page <return page> after the parameter is assigned. The <return page> can be a full URL path or relative

		path according to the current path. If you omit this parameter, it will redirect to an empty page.
--	--	--

Example: Drive the digital output 1 to triggered state and redirect to an empty page

<http://myserver/cgi-bin/dido/setdo.cgi?do1=1>

Query status of the digital input

Note: This request requires the privilege of viewer.

Method: GET/POST

Syntax:

```
http://<servername>/cgi-bin/dido/getdi.cgi?[di0][&di1][&di2][&di3]
```

If no parameter is specified, all the status of digital input will be returned.

Return:

```
HTTP/1.0 200 OK\r\n
Content-Type: text/plain\r\n
Content-Length: <length>\r\n
\r\n
[di0=<state>]\r\n
[di1=<state>]\r\n
[di2=<state>]\r\n
[di3=<state>]\r\n
```

where <state> can be 0 or 1.

Example: Query the status of digital input 1

Request:

<http://myserver/cgi-bin/dido/getdi.cgi?di1>

Response:

```
HTTP/1.0 200 OK\r\n
Content-Type: text/plain\r\n
Content-Length: 7\r\n
\r\n
di1=1\r\n
```

Query status of the digital output

Note: This request requires the privilege of viewer.

Method: GET/POST

Syntax:

```
http://<servername>/cgi-bin/dido/getdo.cgi?[do0][&do1][&do2][&do3]
```

If no parameter is specified, all the status of digital output will be returned.

Return:

```
HTTP/1.0 200 OK\r\n
Content-Type: text/plain\r\n
Content-Length: <length>\r\n
\r\n
[do0=<state>]\r\n
[do1=<state>]\r\n
[do2=<state>]\r\n
[do3=<state>]\r\n
```

where <state> can be 0 or 1.

Example: Query the status of digital output 1

Request:

```
http://myserver/cgi-bin/dido/getdo.cgi?do1
```

Response:

```
HTTP/1.0 200 OK\r\n
Content-Type: text/plain\r\n
Content-Length: 7\r\n
\r\n
do1=1\r\n
```

Capture single snapshot

Note: This request require normal user privilege

Method: GET/POST

Syntax:

```
http://<servername>/cgi-bin/viewer/video.jpg?[channel=<value>][&resolution=<value>]
[&quality=<value>]
```

If the user requests the size larger than all stream setting on the server, this request will failed!

PARAMETER	VALUE	DEFAULT	DESCRIPTION
channel	0~(n-1)	0	the channel number of video source
resolution	<available resolution>	0	The resolution of image
quality	1~5	3	The quality of image

Server will return the most up-to-date snapshot of selected channel and stream in JPEG format. The size and quality of image will be set according to the video settings on the server.

Return:

```
HTTP/1.0 200 OK\r\n
Content-Type: image/jpeg\r\n
[Content-Length: <image size>\r\n]

<binary JPEG image data>
```

Account management

Note: This request requires administrator privilege

Method: GET/POST

Syntax:

```
http://<servername>/cgi-bin/admin/editaccount.cgi?
method=<value>&username=<name>[&userpass=<value>][&privilege=<value>]
[&privilege=<value>][...][&return=<return page>]
```

PARAMETER	VALUE	DESCRIPTION
method	Add	Add an account to server. When using this method, "username" field is necessary. It will use default value of other fields if not specified.

	Delete	Remove an account from server. When using this method, "username" field is necessary, and others are ignored.
	edit	Modify the account password and privilege. When using this method, "username" field is necessary, and other fields are optional. If not specified, it will keep original settings.
username	<name>	The name of user to add, delete or edit
userpass	<value>	The password of new user to add or that of old user to modify. The default value is an empty string.
privilege	<value>	The privilege of user to add or to modify.
	viewer	viewer's privilege
	operator	operator's privilege
	admin	administrator's privilege
return	<return page>	Redirect to the page <return page> after the parameter is assigned. The <return page> can be a full URL path or relative path according to the current path. If you omit this parameter, it will redirect to an empty page.

System logs

Note: This request require administrator privilege

Method: GET/POST

Syntax:

```
http://<servername>/cgi-bin/admin/syslog.cgi
```

Server will return the up-to-date system log.

Return:

```
HTTP/1.0 200 OK\r\n
Content-Type: text/plain\r\n
Content-Length: <syslog length>\r\n
\r\n
<system log information>\r\n
```

Configuration file (optional)

Note: This request requires administrator privilege

Method: GET/POST

Syntax:

```
http://<servername>/cgi-bin/admin/configfile.cgi?[format=<value>]
```

Server will return the up-to-date configuration file.

PARAMETER	VALUE	DEFAULT	DESCRIPTION
format	xml	xml	the format for config file.

Return:

```
HTTP/1.0 200 OK\r\n
Content-Type: text/plain\r\n
Content-Length: <configuration file length>\r\n
\r\n
<configuration data>\r\n
```

Upgrade firmware

Note: This request requires administrator privilege

Method: POST

Syntax:

```
http://<servername>/cgi-bin/admin/upgrade.cgi
```

Post data:

```
fimage=<file name>[&return=<return page>]\r\n
\r\n
<multipart encoded form data>
```

Server will accept the upload file named <file name> to be upgraded the firmware and return with <return page> if indicated.

Camera Control (**capability.ptzenabled=1**)

Note: This request requires privilege of viewer

Method: GET/POST

Syntax:

```
http://<servername>/cgi-bin/viewer/camctrl.cgi?[channel=<value>][&camid=<value>][&move=<value>]
[&focus=<value>][&iris=<value>][&speedpan=<value>][&speedtilt=<value>][&speedzoom=<value>]
[&speedapp=<value>][&auto=<value>][&zoom=<value>][&zooming=<value>][&speedlink=<value>]
[&vx=<value>&vy=<value>&vs=<value>] [&return=<return page>]
```

PARAMETER	VALUE	DESCRIPTION
channel	<0~(n-1)>	Channel of video source
camid	0,<positive integer>	Camera ID
move	home	Move to camera to home position
	up	Move camera up
	down	Move camera down
	left	Move camera left
	right	Move camera right
speedpan	-5 ~ 5	Set the pan speed
speedtilt	-5 ~ 5	Set the tilt speed
speedzoom	-5 ~ 5	Set the zoom speed
speedapp	-5 ~ 5	Set the auto pan/patrol speed
auto	pan	Auto pan
	patrol	Auto patrol
	stop	Stop camera
zoom	wide	To zoom for larger view with current speed
	tele	To zoom for farer view with current speed
	stop	To stop zoom
zooming	wide	To zoom without stop for larger view with current speed

	tele	To zoom without stop for farer view with current speed
vx	<integer , excluding 0>	The slope of movement = vy/vx, used for joystick control.
vy	<integer>	
vs	0 ~ 7	Set the speed of movement, "0" means stop.
focus	auto	To do auto focus
	far	To focus on farer distance
	near	To focus on nearer distance
iris	auto	Let the Network Camera control iris size
	open	Manually control the iris for bigger size
	close	Manually control the iris for smaller size
speedlink	0 ~ 4	Issue speed link command.
return	<return page>	Redirect to the page <return page> after the parameter is assigned. The <return page> can be a full URL path or relative path according to the current path. If you omit this parameter, it will redirect to an empty page.

ePTZ Camera Control

Note: This request requires camctrl privileges.

Method: GET/POST

Syntax:

```
http://<servername>/cgi-bin/camctrl/eCamCtrl.cgi?channel=<value>&stream=<value>
[&move=<value>][&auto=<value>][&zoom=<value>]
[&zooming=<value>&zs=<value>]
[&vx=<value>&vy=<value>&vs=<value>]
[&speedpan=<value>][&speedtilt=<value>][&speedzoom=<value>][&speedapp=<value>]
[&return=<return page>]
```

PARAMETER	VALUE	DESCRIPTION
channel	<0~(n-1)>	Channel of video source.
stream	<0~(m-1)>	Stream.

move	home	Move to home ROI.
	up	Move up.
	down	Move down.
	left	Move left.
	right	Move right.
auto	pan	Auto pan.
	patrol	Auto patrol.
	stop	Stop auto pan/patrol.
zoom	wide	Zoom larger view with current speed.
	tele	Zoom further with current speed.
zooming	wide or tele	Zoom without stopping for larger view or further view with zs speed, used for joystick control.
zs	0 ~ 6	Set the speed of zooming, "0" means stop.
vx	<integer>	The direction of movement, used for joystick control.
vy	<integer>	
vs	0 ~ 7	Set the speed of movement, "0" means stop.
speedpan	-5 ~ 5	Set the pan speed.
speedtilt	-5 ~ 5	Set the tilt speed.
speedzoom	-5 ~ 5	Set the zoom speed.
speedapp	1 ~ 5	Set the auto pan/patrol speed.
return	<return page>	Redirect to the page <return page> after the parameter is assigned. The <return page> can be a full URL path or relative path according to the current path.

Recall (**capability.ptzenabled=1**)

Note: This request requires privilege of viewer

Method: GET

Syntax:

```
http://<servername>/cgi-bin/viewer/recall.cgi?
```

```
recall=<value>[&channel=<value>][&return=<return page>]
```

PARAMETER	VALUE	DESCRIPTION
recall	Text string less than 30 characters	One of the present positions to recall.
channel	<0~(n-1)>	channel of video source
return	<return page>	Redirect to the page <return page> after the parameter is assigned. The <return page> can be a full URL path or relative path according to the current path. If you omit this parameter, it will redirect to an empty page.

ePTZ Recall

Note: This request requires camctrl privileges.

Method: GET/POST

Syntax:

```
http://<servername>/cgi-bin/camctrl/eRecall.cgi?channel=<value>&stream=<value>&recall=<value>[&return=<return page>]
```

PARAMETER	VALUE	DESCRIPTION
channel	<0~(n-1)>	Channel of the video source.
stream	<0~(m-1)>	Stream.
recall	Text string less than 40 characters	One of the present positions to recall.
return	<return page>	Redirect to the page <return page> after the parameter is assigned. The <return page> can be a full URL path or relative path according to the current path.

Preset Locations (capability.ptzenabled=1)

Note: This request requires operator privilege

Method: GET/POST

Syntax:

```
http://<servername>/cgi-bin/operator/preset.cgi?[channel=<value>]
[&addpos=<value>][&delpos=<value>][&return=<return page>]
```

PARAMETER	VALUE	DESCRIPTION
addpos	<Text string less than 30 characters>	Add one preset location to preset list.
channel	<0~(n-1)>	channel of video source
delpos	<Text string less than 30 characters>	Delete preset location from preset list.
return	<return page>	Redirect to the page <return page> after the parameter is assigned. The <return page> can be a full URL path or relative path according to the current path. If you omit this parameter, it will redirect to an empty page.

ePTZ Preset Locations

Note: This request requires Operator privileges.

Method: GET/POST

Syntax:

```
http://<servername>/cgi-bin/operator/ePreset.cgi?channel=<value>&stream=<value>
[&addpos=<value>][&delpos=<value>][&return=<return page>]
```

PARAMETER	VALUE	DESCRIPTION
channel	<0~(n-1)>	Channel of the video source.
stream	<0~(m-1)>	Stream.
addpos	<Text string less than 40 characters>	Add one preset location to the preset list.
delpos	<Text string less than 40 characters>	Delete preset location from the preset list.

return	<return page>	Redirect to the page <return page> after the parameter is assigned. The <return page> can be a full URL path or relative path according to the current path.
--------	---------------	--

System Information

Note: This request requires normal user privilege (**obsolete**)

Method: GET/POST

Syntax:

```
http://<servername>/cgi-bin/sysinfo.cgi
```

Server will return the system information. In HTTP API version 2, the CapVersion will be 0200. All the fields in the previous version (0100) is obsolete. Please use "getparam.cgi?capability" instead.

Return:

```
HTTP/1.0 200 OK\r\n
Content-Type: text/plain\r\n
Content-Length: <system information length>\r\n
\r\n
Model=<model name of server>\r\n
CapVersion=0200\r\n
```

PARAMETER(supported capability version)	VALUE	DESCRIPTION
Model	system.firmwareversion	Model name of server. Ex:IP3133-VVTK-0100a
CapVersion	MMmm, MM is major version from 00 ~ 99 mm is minor version from 00 ~ 99 ex: 0100	The capability field version

IP filtering

Note: This request requires administrator access privilege

Method: GET/POST

Syntax:

```
http://<servername>/cgi-bin/admin/ipfilter.cgi?
method=<value>&[start=<ipaddress>&end=<ipaddress>][&index=<value>]
[&return=<return page>]
```

PARAMETER	VALUE	DESCRIPTION
Method	addallow	Add a set of allow IP address range to server. Start and end parameters must be specified. If the index parameter is specified, it will try to add starting from index position.
	adddeny	Add a set of deny IP address range to server. Start and end parameters must be specified. If the index parameter is specified, it will try to add starting from index position.
	deleteallow	Remove a set of allow IP address range from server. If start and end parameters are specified, it will try to remove the matched IP address. If index is specified, it will try to remove the address from given index position. [start, end] parameters have higher priority then the [index] parameter.
	deletedeny	Remove a set of deny IP address range from server. If start and end parameters are specified, it will try to remove the matched IP address. If index is specified, it will try to remove the address from given index position. [start, end] parameters have higher priority then the [index] parameter.
start	<ip address>	The start IP address to add or to delete.
end	<ip address>	The end IP address to add or to delete.
index	<value>	The start position to add or to delete.
return	<return page>	Redirect to the page <return page> after the parameter is assigned. The <return page> can be a full URL path or relative path according to the current path. If you omit this parameter, it will redirect to an empty page.

UART HTTP tunnel channel (**capability.nuart>0**)

Note: This request requires operator privilege

Method: GET and POST

Syntax:

```
http://<servername>/cgi-bin/operator/uartchannel.cgi?[channel=<value>]
```

```
-----
GET /cgi-bin/operator/uartchannel.cgi?[channel=<value>]
```

```
x-sessioncookie: string[22]
```

```
accept: application/x-vvtk-tunnelled
```

```
pragma: no-cache
```

```
cache-control: no-cache
```

```
-----
POST /cgi-bin/operator/uartchannel.cgi
```

```
x-sessioncookie: string[22]
```

```
content-type: application/x-vvtk-tunnelled
```

```
pragma : no-cache
```

```
cache-control : no-cache
```

```
content-length: 32767
```

```
expires: Sun, 9 Jan 1972 00:00:00 GMT
```

User must use GET and POST to establish two channels for downstream and upstream. The x-sessioncookie in the GET and POST should be the same to be recognized as a pair for one session. The contents of upstream should be base64 encoded to be able to pass through some proxy server.

This channel will help to transfer the raw data of UART over network.

PARAMETER	VALUE	DESCRIPTION
channel	0 ~ (n-1)	The channel number of UART.

Event/Control HTTP tunnel channel

Note: This request requires **admin** privilege

Method: GET and POST

Syntax:

```
http://<servername>/cgi-bin/admin/ctrlevent.cgi
```

```
-----
GET /cgi-bin/admin/ctrlevent.cgi
```

```
x-sessioncookie: string[22]
accept: application/x-vvtk-tunnelled
pragma: no-cache
cache-control: no-cache

-----
POST /cgi-bin/admin/ ctrlevent.cgi
x-sessioncookie: string[22]
content-type: application/x-vvtk-tunnelled
pragma : no-cache
cache-control : no-cache
content-length: 32767
expires: Sun, 9 Jan 1972 00:00:00 GMT
```

User must use GET and POST to establish two channels for downstream and upstream. The x-sessioncookie in the GET and POST should be the same to be recognized as a pair for one session. The contents of upstream should be base64 encoded to be able to pass through some proxy server.

This channel will help to do real-time event notification and control. The event and control format are described in another document.

Get SDP of Streamings

Note: This request requires viewer access privilege

Method: GET/POST

Syntax:

```
http://<servername>/<network_rtsp_s<0~m-1>_accessname>
```

"m" is the stream number.

"network_accessname_<0~(m-1)>" is the accessname for stream "1" to stream "m". Please refer to the "subgroup of network: rtsp" for setting the accessname of SDP.

You can get the SDP by HTTP GET method.

Open the network streamings

Note: This request requires viewer access privilege

Syntax:

For http push server (mjpeg):

```
http://<servername>/<network_http_s<0~m-1>_accessname>
```

For rtsp (mp4), user needs to input the url below for a rtsp compatible player.

```
rtsp://<servername>/<network_rtsp_s<0~m-1>_accessname>
```

"m" is the stream number.

For detailed streaming protocol, please refer to "control signaling" and "data format" documents.

Senddata (capability.nuart>0)

Note: This request requires privilege of viewer

Method: GET/POST

Syntax:

```
http://<servername>/cgi-bin/viewer/senddata.cgi?  
[com=<value>][&data=<value>][&flush=<value>] [&wait=<value>] [&read=<value>]
```

PARAMETER	VALUE	DESCRIPTION
com	1 ~ <max. com port number>	The target com/rs485 port number
data	<hex decimal data>[,<hex decimal data>]	The <hex decimal data> is s series of digit within 0 ~ 9, A ~ F. Each comma separates the commands by 200 milliseconds.
flush	yes,no	yes: receive data buffer of COM port will be cleared before read. no: do not clear the receive data buffer.
wait	1 ~ 65535	wait time in milliseconds before read data
read	1 ~ 128	the data length in bytes to read. The read data will be in return

	page.
--	-------

Return:

```
HTTP/1.0 200 OK\r\n
Content-Type: text/plain\r\n
Content-Length: <system information length>\r\n
\r\n
<hex decimal data>\r\n
```

Where is hex decimal data is a series of digit within 0 ~ 9, A ~ F

Storage managements (capability.storage.dbenabled=1)

Note: This request requires **administrator** privileges.

Method: GET and POST

Syntax:

```
http://<servername>/cgi-bin/admin/lctrl.cgi?cmd=<cmd_type>[&<parameter>=<value>...]
```

The commands usage and their input arguments are as follows.

PARAMETER	VALUE	DESCRIPTION
cmd_type	<string>	Required. Command to be executed, including <i>search</i> , <i>insert</i> , <i>delete</i> , <i>update</i> , and <i>queryStatus</i> .

Command: **search**

PARAMETER	VALUE	DESCRIPTION
label	<integer primary key>	Optional. The integer primary key column will automatically be assigned a unique integer.
triggerType	<text>	Optional. Indicate the event trigger type. Please embrace your input value with single quotes. Ex. mediaType='motion' Support trigger types are product dependent.
mediaType	<text>	Optional. Indicate the file media type.

		Please embrace your input value with single quotes. Ex. mediaType='videoclip' Support trigger types are product dependent.
destPath	<text>	Optional. Indicate the file location in camera. Please embrace your input value with single quotes. Ex. destPath = '/mnt/auto/CF/NCMF/abc.mp4'
resolution	<text>	Optional. Indicate the media file resolution. Please embrace your input value with single quotes. Ex. resolution='800x600'
isLocked	<boolean>	Optional. Indicate if the file is locked or not. 0: file is not locked. 1: file is locked. A locked file would not be removed from UI or cyclic storage.
triggerTime	<text>	Optional. Indicate the event trigger time. (not the file created time) Format is "YYYY-MM-DD HH:MM:SS" Please embrace your input value with single quotes. Ex. triggerTime='2008-01-01 00:00:00' If you want to search for a time period, please apply "TO" operation. Ex. triggerTime='2008-01-01 00:00:00'+TO+'2008-01-01 23:59:59' is to search for records from the start of Jan 1 st 2008 to the end of Jan 1 st 2008.
limit	<positive integer>	Optional. Limit the maximum number of returned search records.
offset	<positive integer>	Optional. Specifies how many rows to skip at the beginning of the matched records. Note that the offset keyword is used after limit keyword.

To increase the flexibility of search command, you may use "OR" connectors for logical "OR" search operations. Moreover, to search for a specific time period, you can use "TO" connector.

Ex. To search records triggered by motion or di or sequential and also triggered between 2008-01-01 00:00:00 and 2008-01-01 23:59:59.

```
http://<servername>/cgi-bin/admin/lscrtl.cgi?cmd=search&triggerType='motion'+OR+'di'+OR+'seq'&triggerTime='2008-01-01 00:00:00'+TO+'2008-01-01 23:59:59'
```

Command: **delete**

PARAMETER	VALUE	DESCRIPTION
label	<integer primary key>	Required. Identify the designated record. Ex. label=1

Ex. Delete records whose key numbers are 1, 4, and 8.

```
http://<servername>/cgi-bin/admin/lscrtl.cgi?cmd=delete&label=1&label=4&label=8
```

Command: **update**

PARAMETER	VALUE	DESCRIPTION
label	<integer primary key>	Required. Identify the designated record. Ex. label=1
isLocked	<boolean>	Required. Indicate if the file is locked or not.

Ex. Update records whose key numbers are 1 and 5 to be locked status.

```
http://<servername>/cgi-bin/admin/lscrtl.cgi?cmd=update&isLocked=1&label=1&label=5
```

Ex. Update records whose key numbers are 2 and 3 to be unlocked status.

```
http://<servername>/cgi-bin/admin/lscrtl.cgi?cmd=update&isLocked=0&label=2&label=3
```

Command: queryStatus

PARAMETER	VALUE	DESCRIPTION
retType	xml or javascript	Optional. Ex. retype=javascript The default return message is in XML format.

Ex. Query local storage status and call for javascript format return message.

```
http://<servername>/cgi-bin/admin/lscrtl.cgi?cmd=queryStatus&retType=javascript
```

Technical Specifications

System <ul style="list-style-type: none"> · CPU: Mozart 120 SoC · Flash: 16MB · RAM: 128MB + 128MB · Embedded OS: Linux 2.6 	Alarm and Event Management <ul style="list-style-type: none"> · Triple-window video motion detection · Tamper detection · One D/I and one D/O for external sensor and alarm · Event notification using HTTP, SMTP or FTP · Local recording of MP4 file
Lens <ul style="list-style-type: none"> · CS-mount, vari-focal, f = 4.5 ~ 10 mm, F1.6, auto-iris · Removable IR-cut filter for day & night function 	On-board Storage <ul style="list-style-type: none"> · SD/SDHC card slot · Stores snapshots and video clips
Angle of View <ul style="list-style-type: none"> · 37.1° ~ 77.6° (horizontal) 	Security <ul style="list-style-type: none"> · Multi-level user access with password protection · IP address filtering · HTTPS encrypted data transmission · 802.1X port-based authentication for network protection
Shutter Time <ul style="list-style-type: none"> · 1/5 sec. to 1/40,000 sec. 	Users <ul style="list-style-type: none"> · Live viewing for up to 10 clients
Image Sensor <ul style="list-style-type: none"> · 1/3.2" CMOS sensor in 1600x1200 resolution 	Dimension <ul style="list-style-type: none"> · 154 mm (D) x 72 mm (W) x 62 mm (H)
Minimum Illumination <ul style="list-style-type: none"> · 0.8 Lux / F1.6 	Weight <ul style="list-style-type: none"> · Net: 662 g
Video <ul style="list-style-type: none"> · Compression: MJPEG & MPEG-4 · Streaming: <ul style="list-style-type: none"> Simultaneous multiple streams MPEG-4 streaming over UDP, TCP, HTTP or HTTPS MPEG-4 multicast streaming MJPEG streaming over HTTP or HTTPS · Supports activity adaptive streaming for dynamic frame rate control · Supports ePTZ for data efficiency · Supports 3GPP mobile surveillance · Frame rates: <ul style="list-style-type: none"> MPEG-4: up to 30 fps at 800x600 up to 10 fps at 1600x1200 MJPEG: up to 30 fps at 800x600 up to 15 fps at 1600x1200 	LED Indicator <ul style="list-style-type: none"> · System power and status indicator · System activity and network link indicator
Image Settings <ul style="list-style-type: none"> · Adjustable image size, quality, and bit rate · Time stamp and text caption overlay · Flip & mirror · Configurable brightness, contrast, saturation, sharpness, white balance and exposure · AGC, AWB, AES · Automatic, manual or scheduled day/night mode · BLC (Backlight Compensation) · Supports privacy masks 	Power <ul style="list-style-type: none"> · 12V DC · 24V AC · Power consumption: Max. 8 W · 802.3af compliant Power-over-Ethernet
Audio <ul style="list-style-type: none"> · Compression: <ul style="list-style-type: none"> GSM-AMR speech encoding, bit rate: 4.75 kbps to 12.2 kbps MPEG-4 AAC audio encoding, bit rate: 16 kbps to 128 kbps · Interface: <ul style="list-style-type: none"> Built-in microphone External microphone input Audio output External/Internal microphone switch · Supports two-way audio via SIP protocol · Supports audio mute 	Approvals <ul style="list-style-type: none"> · CE, LVD, FCC, VCCI, C-Tick
Networking <ul style="list-style-type: none"> · 10/100 Mbps Ethernet, RJ-45 · Protocols: IPv4, IPv6, TCP/IP, HTTP, HTTPS, UPnP, RTSP/RTP/RTCP, IGMP, SMTP, FTP, DHCP, NTP, DNS, DDNS, PPPoE, CoS, QoS, SNMP and 802.1X 	Operating Environments <ul style="list-style-type: none"> · Temperature: 0 ~ 50 °C (32 ~ 122 °F) · Humidity: 90% RH
	Viewing System Requirements <ul style="list-style-type: none"> · OS: Microsoft Windows 2000/XP/Vista · Browser: Mozilla Firefox, Internet Explorer 6.x or above · Cell phone: 3GPP player · Real Player: 10.5 or above · Quick Time: 6.5 or above
	Installation, Management, and Maintenance <ul style="list-style-type: none"> · RS-485 interface for scanners, pan/tilts · Installation Wizard 2 · 32-CH ST7501 central management software · Supports firmware upgrade
	Applications <ul style="list-style-type: none"> · SDK available for application development and system integration
	Warranty <ul style="list-style-type: none"> · 24 months

All specifications are subject to change without notice. Copyright © 2009 VIVOTEK INC. All rights reserved.

Technology License Notice

MPEG-4 AAC Technology

THIS PRODUCT IS LICENSED UNDER THE MPEG-4 AAC AUDIO PATENT LICENSE. THIS PRODUCT MAY NOT BE DECOMPILED, REVERSE-ENGINEERED OR COPIED, EXCEPT WITH REGARD TO PC SOFTWARE, OF WHICH YOU MAY MAKE SINGLE COPIES FOR ARCHIVAL PURPOSES. FOR MORE INFORMATION, PLEASE REFER TO [HTTP://WWW.VIALICENSING.COM](http://www.vialicensing.com).

MPEG-4 Visual Technology

THIS PRODUCT IS LICENSED UNDER THE MPEG-4 VISUAL PATENT PORTFOLIO LICENSE FOR THE PERSONAL AND NON-COMMERCIAL USE OF A CONSUMER FOR (i) ENCODING VIDEO IN COMPLIANCE WITH THE MPEG-4 VISUAL STANDARD ("MPEG-4 VIDEO") AND/OR (ii) DECODING MPEG-4 VIDEO THAT WAS ENCODED BY A CONSUMER ENGAGED IN A PERSONAL AND NON-COMMERCIAL ACTIVITY AND/OR WAS OBTAINED FROM A VIDEO PROVIDER LICENSED BY MPEG LA TO PROVIDE MPEG-4 VIDEO. NO LICENSE IS GRANTED OR SHALL BE IMPLIED FOR ANY OTHER USE. ADDITIONAL INFORMATION INCLUDING THAT RELATING TO PROMOTIONAL, INTERNAL AND COMMERCIAL USES AND LICENSING MAY BE OBTAINED FROM MPEG LA, LLC. PLEASE REFER TO [HTTP://WWW.MPEGLA.COM](http://www.mpeg-la.com).

AMR-NB Standard

THIS PRODUCT IS LICENSED UNDER THE AMR-NB STANDARD PATENT LICENSE AGREEMENT. WITH RESPECT TO THE USE OF THIS PRODUCT, THE FOLLOWING LICENSORS' PATENTS MAY APPLY:

TELEFONAKIEBOLAGET ERICSSON AB: US PAT. 6192335; 6275798; 6029125; 6424938; 6058359. NOKIA CORPORATION: US PAT. 5946651; 6199035. VOICEAGE CORPORATION: AT PAT. 0516621; BE PAT. 0516621; CA PAT. 2010830; CH PAT. 0516621; DE PAT. 0516621; DK PAT. 0516621; ES PAT. 0516621; FR PAT. 0516621; GB PAT. 0516621; GR PAT. 0516621; IT PAT. 0516621; LI PAT. 0516621; LU PAT. 0516621; NL PAT. 0516621; SE PAT. 0516621; US PAT. 5444816; AT PAT. 819303/AT E 198805T1; AU PAT. 697256; BE PAT. 819303; BR PAT. 9604838-7; CA PAT. 2216315; CH PAT. 819303; CN PAT. ZL96193827.7; DE PAT. 819303/DE69611607T2; DK PAT. 819303; ES PAT. 819303; EP PAT. 819303; FR PAT. 819303; GB PAT. 819303; IT PAT. 819303; JP PAT. APP. 8-529817; NL PAT. 819303; SE PAT. 819303; US PAT. 5664053. THE LIST MAY BE UPDATED FROM TIME TO TIME BY LICENSORS AND A CURRENT VERSION OF WHICH IS AVAILABLE ON LICENSOR'S WEBSITE AT [HTTP://WWW.VOICEAGE.COM](http://www.voiceage.com).

Electromagnetic Compatibility (EMC)

FCC Statement

This device complies with FCC Rules Part 15. Operation is subject to the following two conditions.

- This device may not cause harmful interference, and
- This device must accept any interference received, including interference that may cause undesired operation.

This equipment has been tested and found to comply with the limits for a Class B digital device, pursuant to Part 15 of the FCC Rules. These limits are designed to provide reasonable protection against harmful interference in a residential installation. This equipment generates, uses and can radiate radio frequency energy and, if not installed and used in accordance with the instructions, may cause harmful interference to radio communications. However, there is no guarantee that interference will not occur in a partial installation. If this equipment does cause harmful interference to radio or television reception, which can be determined by turning the equipment off and on, the user is encouraged to try to correct the interference by one or more of the following measures:

- Reorient or relocate the receiving antenna.
- Increase the separation between the equipment and receiver.
- Connect the equipment into an outlet on a circuit different from that to which the receiver is connected.
- Consult the dealer or an experienced radio/TV technician for help.

Shielded interface cables must be used in order to comply with emission limits.

CE Mark Warning

This is a Class B product. In a domestic environment, this product may cause radio interference, in which case the user may be required to take adequate measures.

Liability

VIVOTEK Inc. cannot be held responsible for any technical or typographical errors and reserves the right to make changes to the product and manuals without prior notice. VIVOTEK Inc. makes no warranty of any kind with regard to the material contained within this document, including, but not limited to, the implied warranties of merchantability and fitness for any particular purpose.