

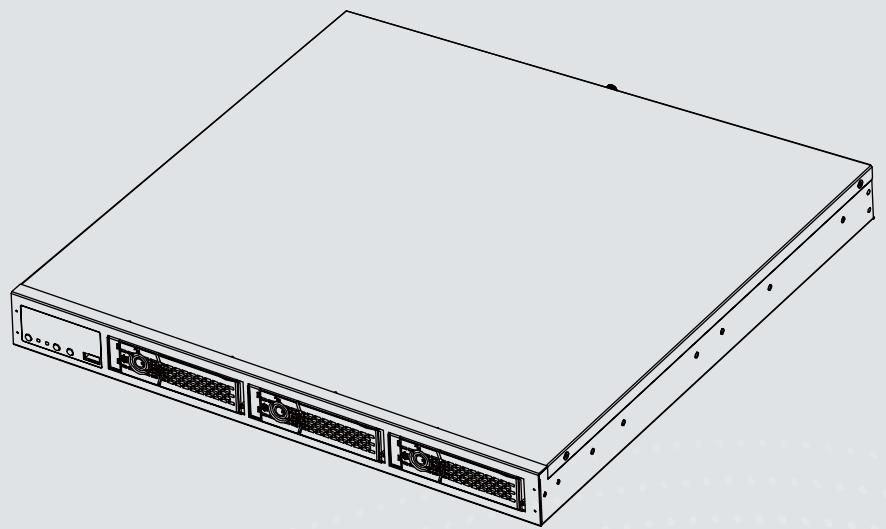

NR8401 Network Video Recorder User's Manual

16-channel • Rack-mount Enclosure •
Full Integration with VIVOTEK Cameras



Rev. 1.1

Table of Contents

| | |
|--|-----------|
| Revision History | 4 |
| Chapter One Hardware Installation and Initial Configuration | 5 |
| Introducing NR8401 Network Video Recorder | 5 |
| Special Features | 5 |
| Safety | 6 |
| Physical Description | 7 |
| Hardware Installation..... | 9 |
| Network Deployment..... | 12 |
| Initial Configuration..... | 13 |
| Rack-mounting | 18 |
| Attaching Foot Pads..... | 23 |
| LED Indicators..... | 23 |
| Power Up and Power Down | 24 |
| Chapter Two Login and Getting Started | 25 |
| 2-1. Login | 25 |
| 2-2. Graphical Layout and Screen Elements - Liveview..... | 29 |
| 2-2-1. Camera List Panel | 30 |
| 2-2-2. Layout..... | 32 |
| 2-2-3. Layout contents | 33 |
| 2-2-4. Logo & Menu | 33 |
| 2-2-5. View Cell panel | 34 |
| Adding Cameras to View Cells..... | 34 |
| 2-2-6. PTZ panel | 43 |
| 2-2-7. Alarm panel..... | 45 |
| 2-3. Graphical Layout and Screen Elements - Playback..... | 49 |
| 2-3-1. Camera List Panel | 50 |
| 2-3-2. Playback Layout | 51 |
| 2-3-3. Logo & Menu | 51 |
| 2-3-4. Playback View Cells..... | 52 |
| 2-3-5. Alarm Panel | 55 |
| 2-3-6. Calendar Panel | 56 |
| Chapter Three System Settings | 57 |
| 3-1. System | 58 |
| 3-1-1. System - General..... | 58 |
| 3-1-2. System - Upgrade..... | 59 |
| 3-1-3. System - Backup..... | 60 |
| 3-1-4. System - Maintenance | 63 |
| UPS support..... | 65 |
| 3-1-5. System - DI and DO..... | 66 |
| 3-2. Network..... | 67 |
| 3-2-1. Network - General..... | 67 |

| | |
|--|------------|
| 3-2-2. Network - DDNS | 69 |
| 3-2-3. Network - Service | 71 |
| 3-2-4. Network - Utility..... | 72 |
| 3-3. Camera | 73 |
| 3-3-1. Camera - General | 73 |
| 3-3-2. Camera - Video..... | 79 |
| 3-3-3. Camera - Schedule..... | 80 |
| 3-4. Storage..... | 82 |
| 3-4-1. Storage - Volume | 82 |
| 3-4-2. Storage - Disk | 93 |
| 3-5. Security | 95 |
| 3-5-1. User account..... | 95 |
| 3-5-2. Access list | 98 |
| 3-6. Alarm | 99 |
| 3-6-1. General | 99 |
| 3-6-2. Editing Alarms via Source, Action, and Schedule | 109 |
| 3-6-3. Alarm - History | 110 |
| 3-7. Logs | 111 |
| Chapter Four Operation..... | 114 |
| 4-1. Liveview | 114 |
| 4-1-1. Placing Cameras into the Layout..... | 114 |
| 4-1-2. PTZ and Other Screen Controls | 118 |
| 4-1-3. Audio..... | 121 |
| 4-1-4. Camera Properties and Controls | 122 |
| 4-1-5. Alarm Panel | 123 |
| 4-1-6. Layout view Control Buttons | 124 |
| 4-2. Playback..... | 125 |
| 4-2-1. Begin Playback and Search for Past Recordings | 125 |
| 4-2-2. Past Alarms and Bookmarks..... | 126 |
| 4-2-3. Synchronous Playback | 127 |
| 4-2-4. Export media..... | 128 |
| 4-2-5. Time Search..... | 130 |
| 4-3. Other Functions - Using the Backup Button..... | 132 |
| Technical Specifications | 133 |
| Safety and Compatibility..... | 134 |

Revision History

Rev. 1.0: Initial release.

Rev. 1.1: * Added description for the NVR DI/DO-related functions, including DI/DO connections, Toggle DO, NVR DI as Alarm triggers, etc.
* Added description for the Alarm History.
* Added description for the Default routing interface.
* Added storage restoration rules in the backup-restore procedure.
* Added a DI/DO connection diagram.

Read Before Use

The use of surveillance devices may be prohibited by law in your country. The Network Camera is not only a high-performance web-ready camera but can also be part of a flexible surveillance system. It is the user's responsibility to ensure that the operation of such devices is legal before installing this unit for its intended use.

It is important to first verify that all contents received are complete according to the Package Contents listed below. Take note of the warnings in the Quick Installation Guide before the Network Camera is installed; then carefully read and follow the instructions in the Installation chapter to avoid damage due to faulty assembly and installation. This also ensures the product is used properly as intended.

The Network Camera is a network device and its use should be straightforward for those who have basic networking knowledge. It is designed for various applications including video sharing, general security/surveillance, etc. The Configuration chapter suggests ways to best utilize the Network Camera and ensure proper operations. For creative and professional developers, the URL Commands of the Network Camera section serves as a helpful reference to customizing existing homepages or integrating with the current web server.

Package Contents

- NR8401
- Power cord
- Software CD
- Warranty Card
- Quick Installation Guide
- Screws, Chassis ears, bezel keys, and foot pads



NOTE:

The operating system and management software are installed on a flash memory mounted on the main board. Except for the plug-ins for onscreen display, there is no need to install software.

Chapter One Hardware Installation and Initial Configuration

Introducing NR8401 Network Video Recorder

NR8401 is the 16-channel Linux embedded NVR from VIVOTEK, bringing stable and efficient system operation under a wide range of recording/network management/system settings. The unit supports all VIVOTEK camera models, including the latest 5-Megapixel and fisheye cameras.

The NR8401 is equipped with two gigabit ethernet RJ45 ports which provide network failover/load balance functionality to avoid the risk of recording loss. The front panel provides an easy backup button for users to backup/restore NVR configurations, which is very useful for a rack-mount chassis system. Up to 4 HDDs can be added to the NR8401 for a total storage capacity of up to 16TB (4TB*4). Three removable HDD trays are available in the front of the unit, with hot-swap functionality for easy replacement, and support the RAID 0/1/5 application for video data protection and mirroring.

A CMS server running VAST software can also directly control the NR8401, and compatibility with the iViewer application allows for remote access to the NR8401 on handheld devices. By integrating all of the components together using VIVOTEK's NR8401, network cameras, VAST, and iViewer software, users can realize a fully-featured and robust next-generation surveillance system.

Special Features

- Runs on embedded Linux
- 1U Rack Mount Design
- RAID 0, 1, 5 Storage Solution
- 4 x HDD Tray, for a max. capacity of 12TB
- 2 x Gigabit RJ45 Ethernet ports
- 3 x USB Port (1 x Front / 2 x Back)
- Size: 430 mm (W) x 421 mm (D) x 44 mm (H)
- 16-CH Live View & 4-CH Synchronous Playback
- H.264/ MPEG-4
- PTZ Support
- Snapshot / Export Media
- PiP Video Control
- Bookmark Design
- Fast Configuration Backup / Restore
- Compatible with VIVOTEK VAST Central Management Software*
- Full Integration with VIVOTEK Network Cameras
- VIVOTEK iViewer Support (iOS/Android)

*The VIVOTEK VAST Central Management Software is not included in the package.

Safety

- Connect the system to an earthed main power outlet.
- Never open the housing of the power supply unit.
- Install and operate the system only in a dry, weather-proof location.
- Observe the following safety factors:
 - Is there visible damage to the system or power cord
 - Is the system operating correctly.
 - Has the system been exposed to rain or moisture
 - Has the system been in a long storage under harsh conditions or exposed to unconfirming stress.
- The relevant electrical engineering regulations must be complied with at all times during installation.
- Ensure that all maintenance and repair work is handled by qualified personnel such as electrical engineers or network specialists.
- Read this manual before installing or operating the system. The documentation contains important safety instructions about permitted uses.
- The rated AC input is: **100-240V~ 3-1.5A, 60-50Hz**; the max. output power: **150W** (+3.3V&+5V=85W)
- If a fault occurs, disconnect the power cord from the power supply.
- Do not install the system close to heaters or other heat sources. Avoid locations with direct sunlight.
- All ventilation openings must be not be blocked.
- Use only the cables shipped with system or use appropriate cables that can withstand electromagnetic interference.

Symbols and Statements in this Document



INFORMATION: provides important messages or advices that might help prevent inconvenient or problem situations.



NOTE: Notices provide guidance or advices that are related to the functional integrity of the machine.



Tips: Tips are useful information that helps enhance or facilitae an installation, function, or process.



WARNING! or **IMPORTANT:** These statements indicate situations that can be dangerous or hazardous to the machine or you.



Electrical Hazard: This statement appears when high voltage electrical hazards might occur to an operator.

Physical Description

● Front View

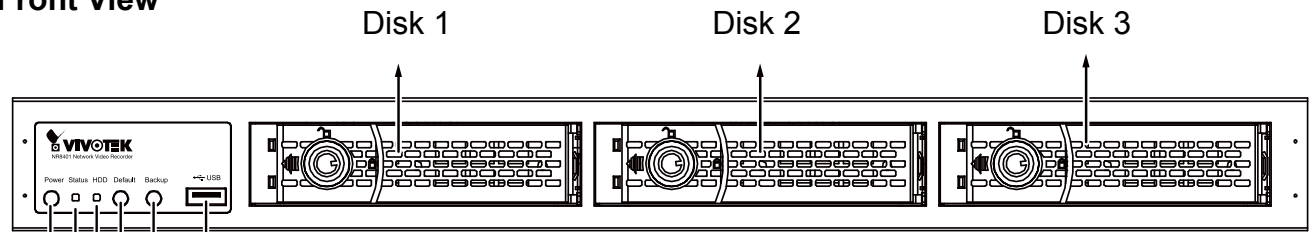

| | |
|---|------------------------|
| 1 | Power button and LED |
| 2 | Status LED |
| 3 | HDD activity LED |
| 4 | Restore Default button |
| 5 | Backup button |
| 6 | USB |

Disk 4 can be installed inside the chassis. See page 17 for information.

● Rear View

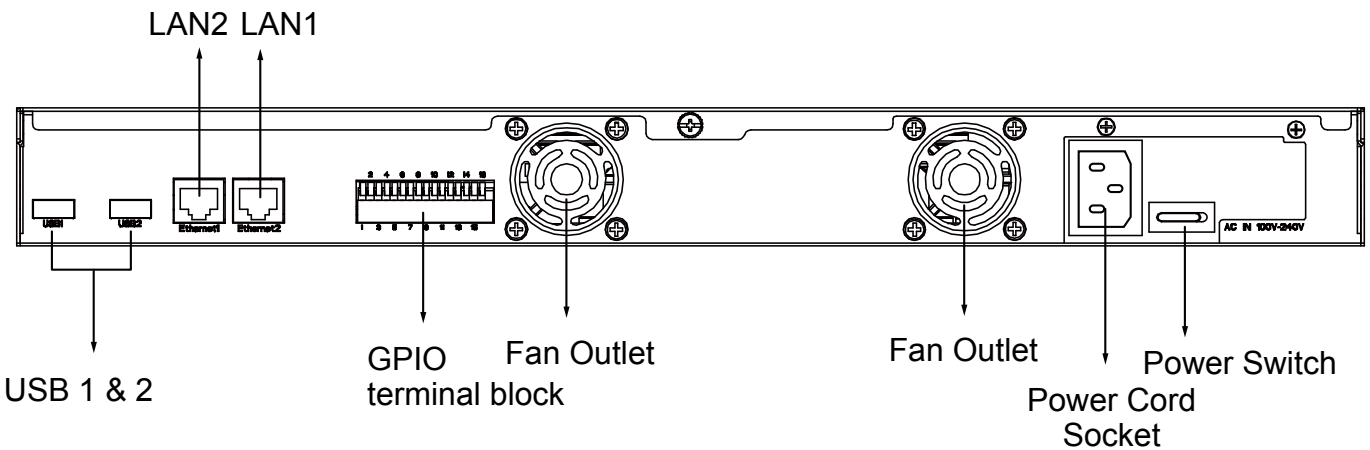

| | | | | | | | |
|---|-----------|----|------|----|--------------|----|-----|
| 1 | DO+ (12V) | 6 | DI2- | 11 | Power button | 16 | GND |
| 2 | DO- | 7 | DI3+ | 12 | GND | | |
| 3 | DI1+ | 8 | DI3- | 13 | RS232_TX | | |
| 4 | DI1- | 9 | DI4+ | 14 | RS232_RX | | |
| 5 | DI2+ | 10 | DI4- | 15 | GND | | |

NOTE:

DI*- (minus) stands for Ground pins.

The digital output connection is diagrammed as follows:

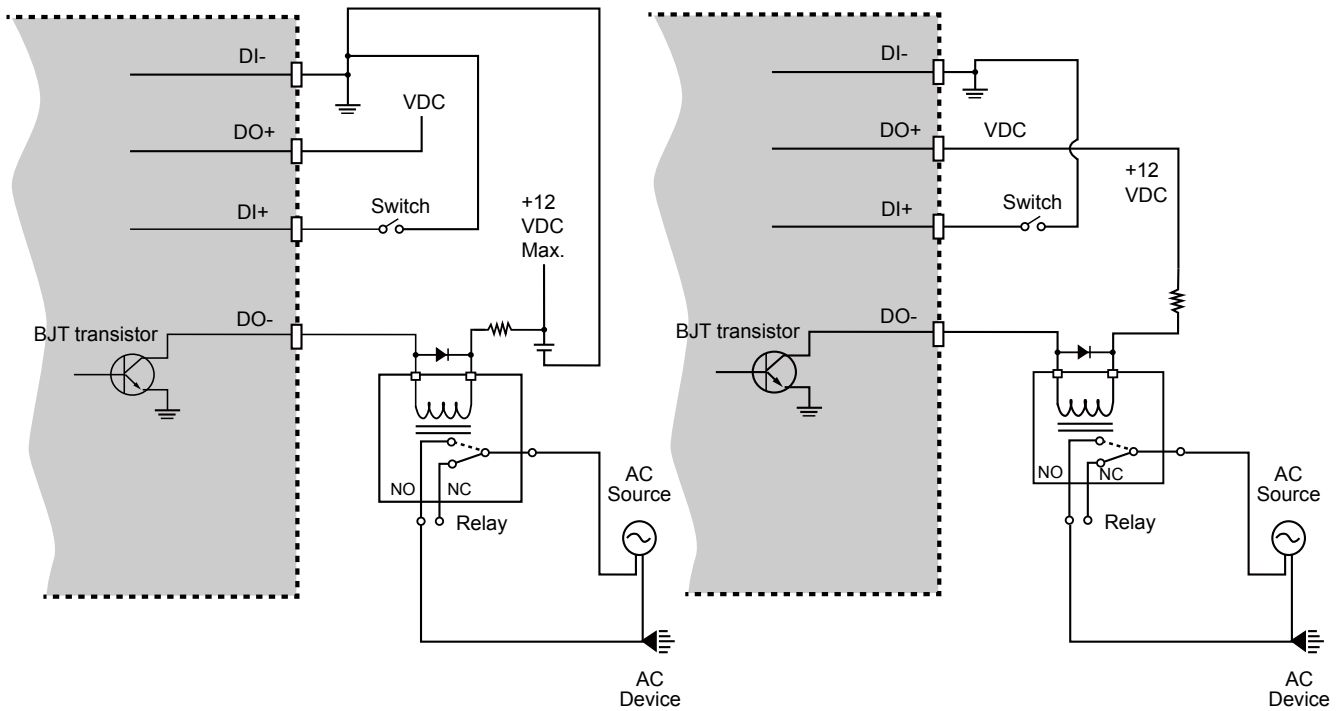

The maximum load on DO pins is 50mA.

! IMPORTANT:

It is important to leave a clearance of 10cm to the rear side of the chassis. The clearance is required to ensure an adequate airflow through the chassis to ventilate heat. A 5cm clearance is also required on the front of the chassis.

To ensure normal operation, maintain ambient airflow. Do not block the airflow around chassis such as placing the system in a closed cabinet.

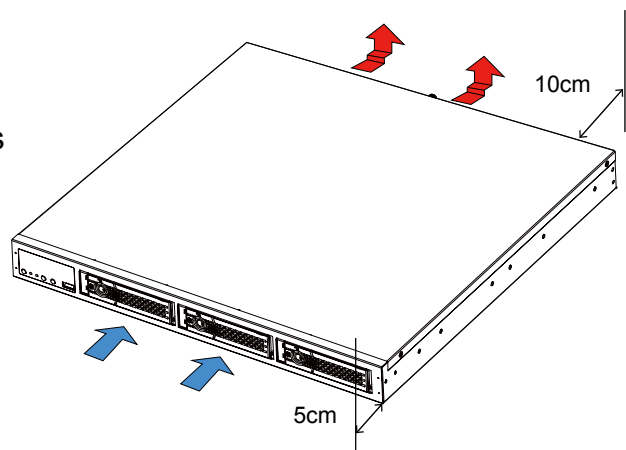

⚠ IMPORTANT:

For a RAID volume configuration, it is recommended you use hard drives of the same model featuring the same capacity and rotation speed. It is also preferred that these drives are running the same version of firmware.

Hardware Installation

SATA hard disk(s) are user-supplied. The network video recorder can readily accommodate most of the off-the-shelf SATA hard drives.

1. Use the included bezel key to unlock the rotary bezel lock. Open the drive bay bezel by pulling the door latch to the side.

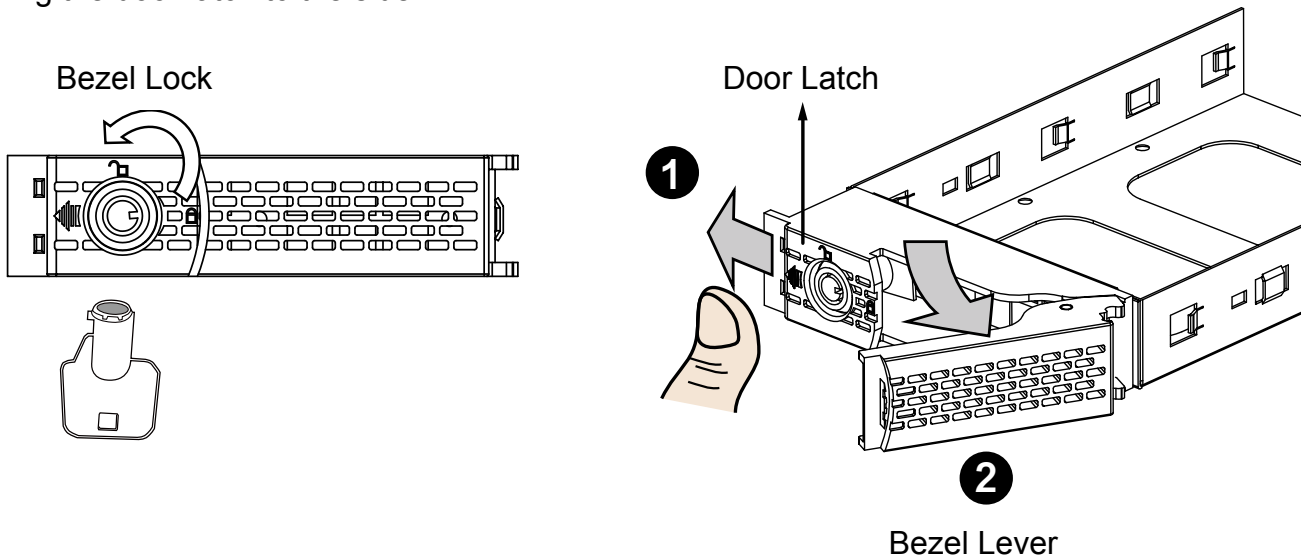

2. Install your hard disk to the drive tray. Gently put the hard disk into drive tray with its label side facing up and the connector side facing the inside of the chassis. Secure the hard disk by driving screws from the bottom.

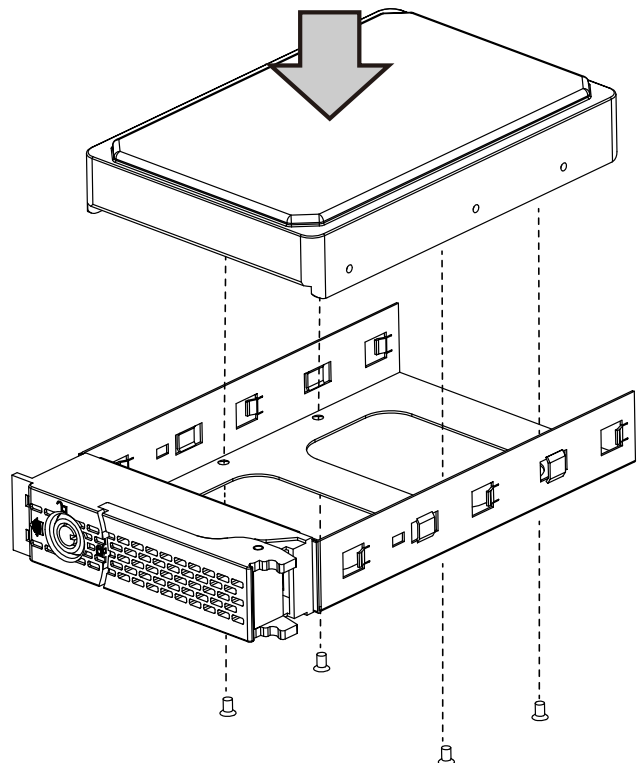



IMPORTANT:

Avoid touching the hard drive's circuit board or connector pins. Doing so can damage the hard drive by electro-static discharge.

3. Insert the hard drive into drive bay.

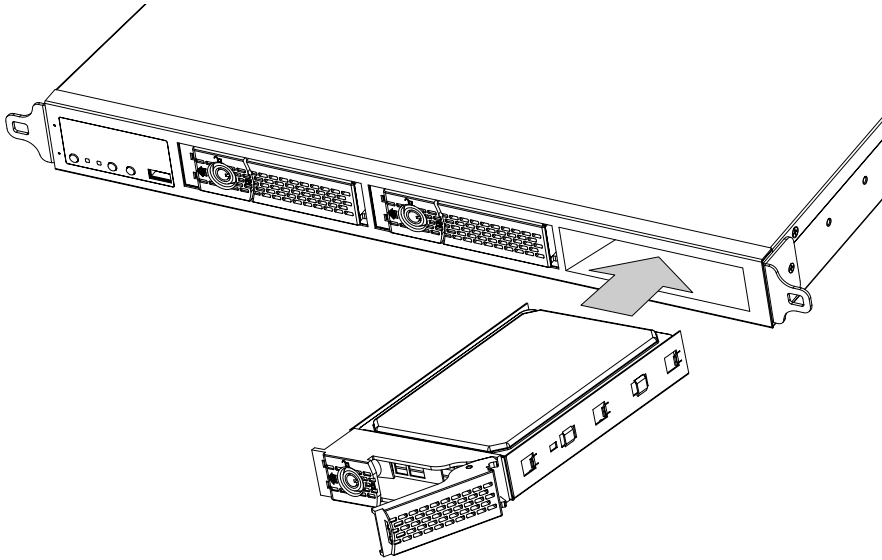

- 4. 4-1. Push the hard drive into bay until you feel the contact resistance.
- 4-2. Close the bezel lever to connect the hard drive to the back-end connector.
- 4-3. You should always lock the drive bezel when the drive bay is populated. This ensures the hard drive is securely installed.

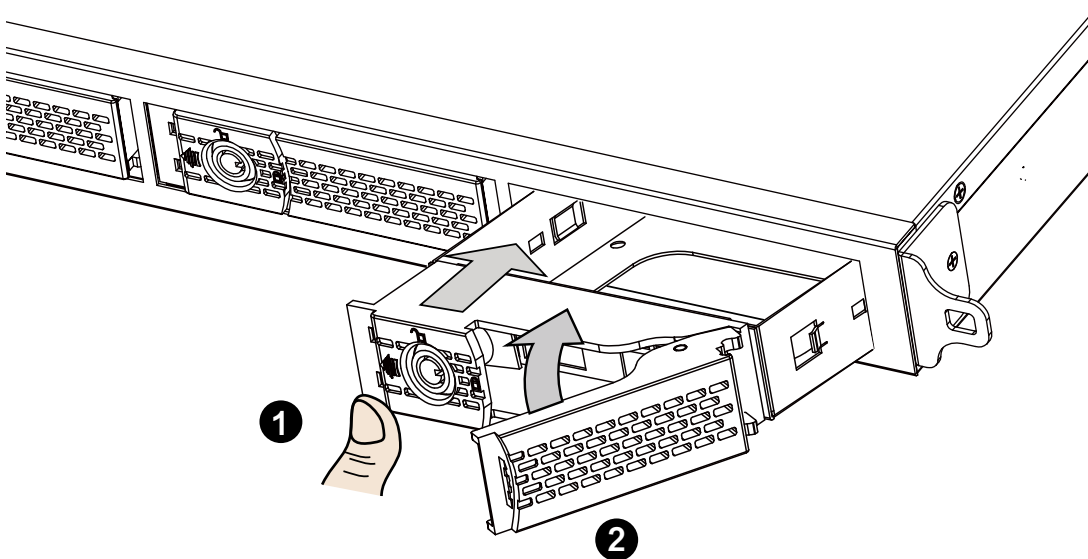

5. Repeat the process above to install more hard drives.

Interface Connections

- 1 & 2. Connect CAT5e or better-quality Ethernet cables to cameras via a local, switched network, or clients through the Internet. Refer to next page for more information.
3. Connect USB devices such as USB optical drive or UPS.
4. Connect external digital input/output devices to the GPIO terminal block.
5. Make sure the power switch on the rear panel is in the OFF (O) position. Connect the supplied power cord to the power mains (100-240V AC, 50~60Hz).

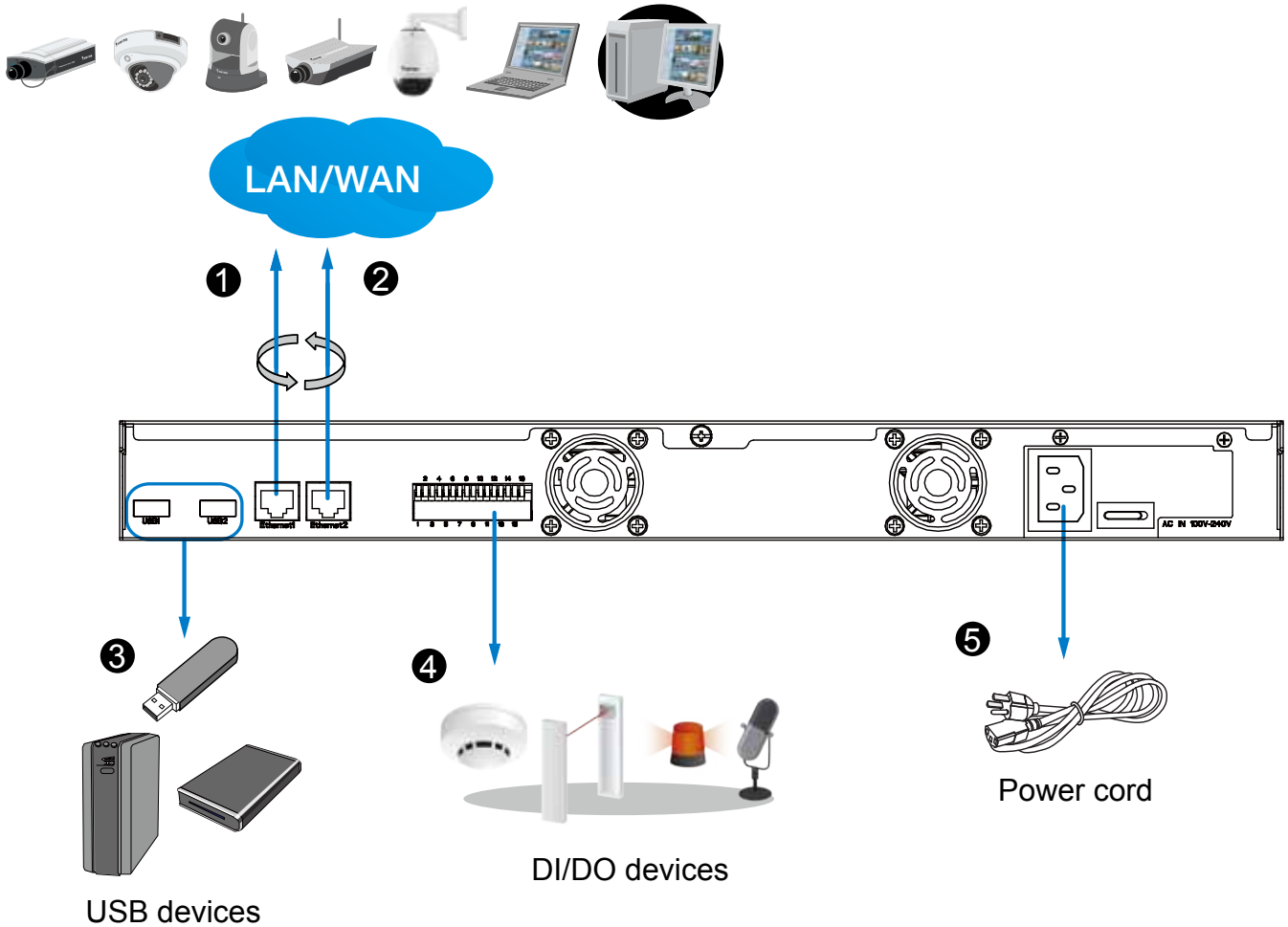

NOTE:

Cameras and the NVR must reside in the same subnet. Otherwise, the NVR will not be able to recruit them as a recording configuration.

Network Deployment

1. Connect network cameras to the NVR's LAN ports.
2. Internet access to the NVR is made through the TCP port 80 and RTSP streaming via port 554.

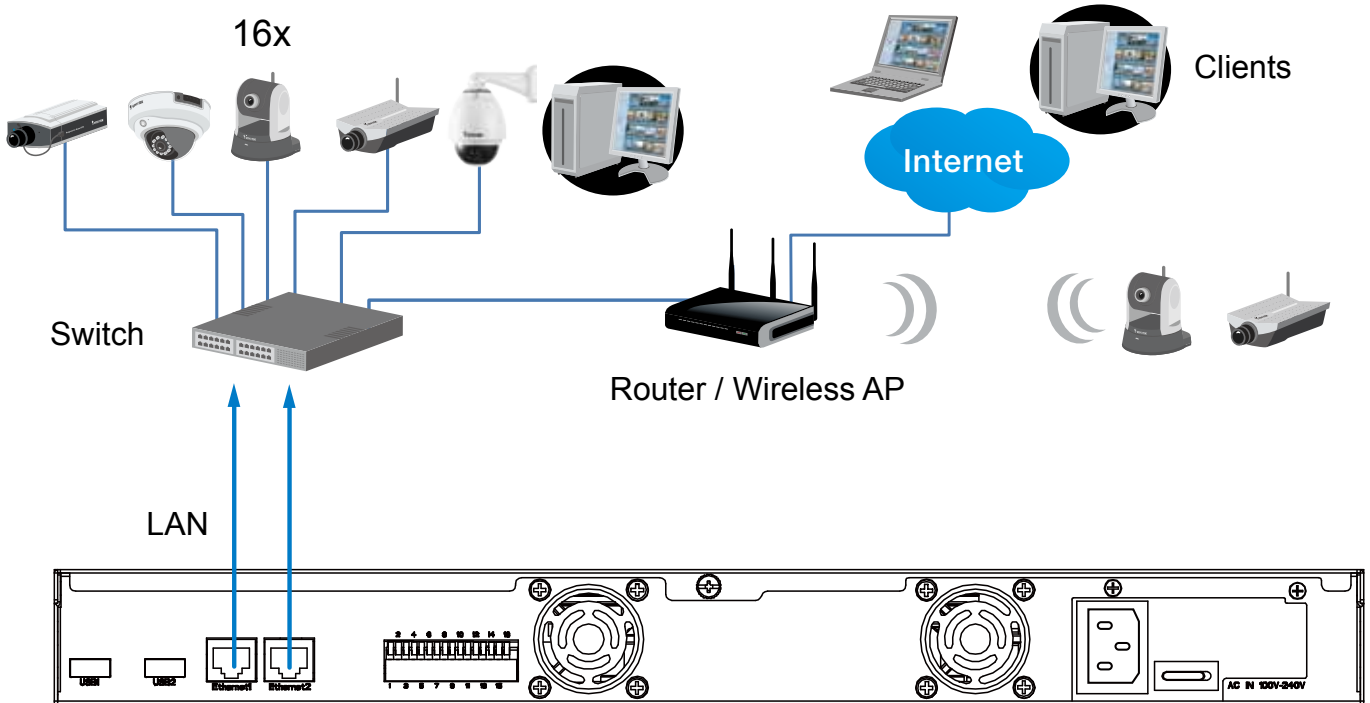

⚠ IMPORTANT:

1. The two LAN ports must not be managed by different DHCP servers or routers.
2. It is recommended all network cameras use static IPs. If you let a DHCP server assign IPs to these cameras, IPs may be changed later and the NVR may not recognize them.
3. The NVR only receives H.264 and MPEG-4 video streams. If your cameras are configured to deliver MJPEG streams, please change their video stream configuration.
4. The maximum recording bandwidth is 96Mbps using single disks or RAID0/1, and 48Mbps using a RAID5 volume.

✍ NOTE:

1. The two LAN ports can be configured into the same or different subnets, or into a failover or load-sharing trunk group.
2. Client computers should support IE8 browser at a minimum of 1280x960 resolution or higher.

Initial Configuration

1. Press the power switch on the rear panel to the ON (I) position. The NVR should start immediately. To start the system again after the initial configuration, use the front panel power button.
2. From a management computer, install the **IW2** utility software included in the product CD. Follow the onscreen instructions to complete the installation.

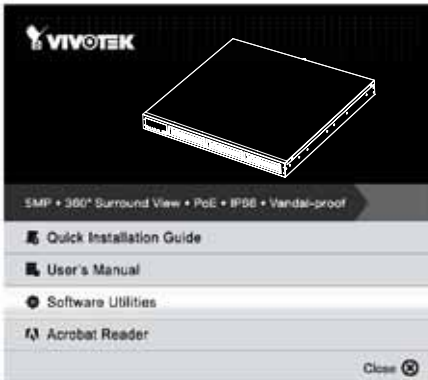

3. Start the IW2 utility. The IW2 utility will discover the NR8401 located in the same subnet.
4. Double-click on the NR8401 entry to start a web session with the NVR system.



5. The login page will prompt. Enter "admin" and "admin" as user name and password for access for the first time. Click **Login** to begin your configuration.



6. The system will default to the **LiveClient** page. Click on the **Settings** button on the upper right corner of the screen.

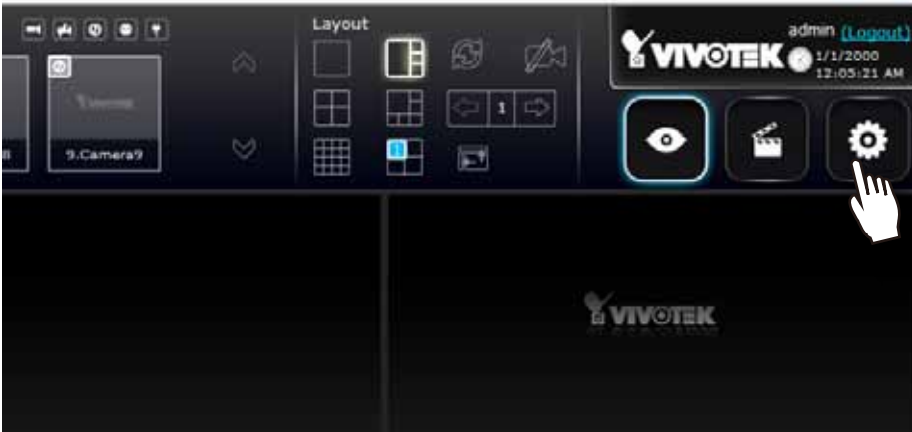

7. On the Settings page, click on **Storage > Volume** to access your storage volume configuration.

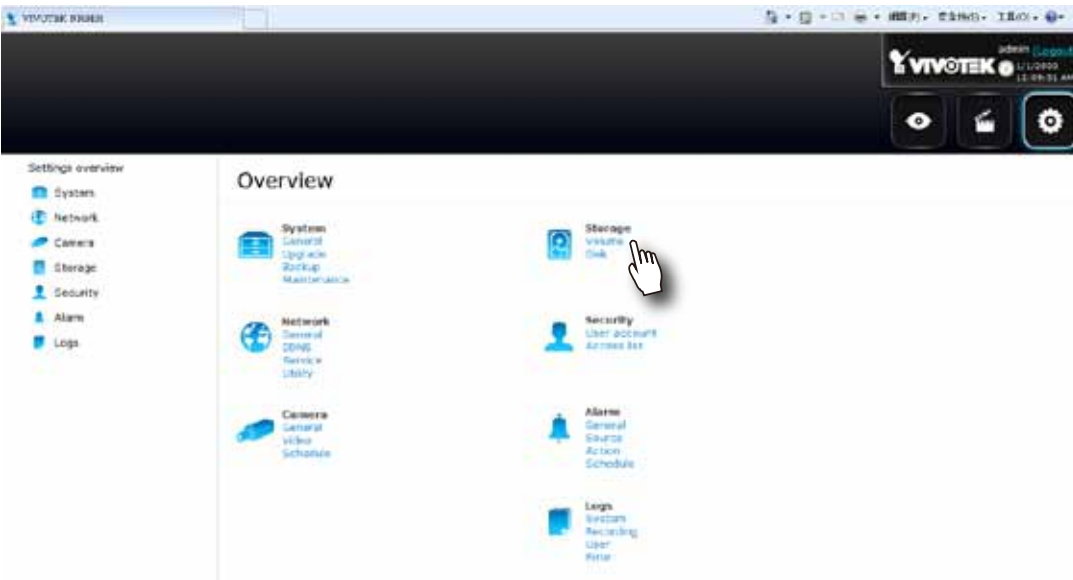

8. On the **Storage** settings page, check if your hard drives are present and identified by your system. Click on the **Create...** button.

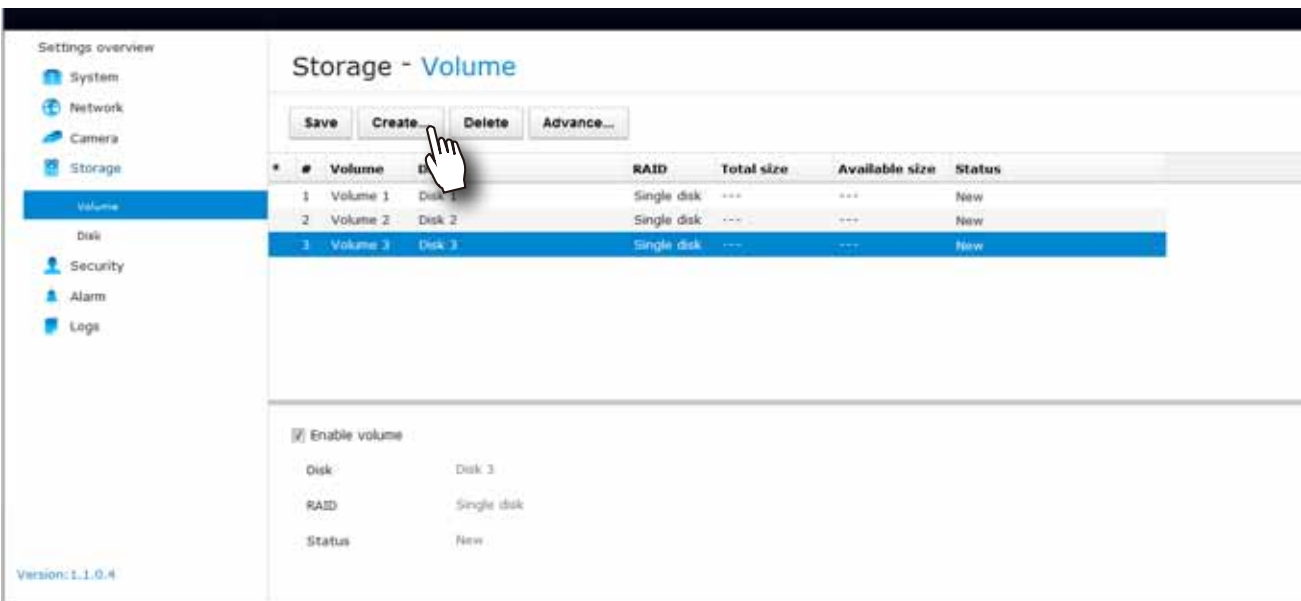

9. Depending on the number of hard drives you installed, a list of RAID volume configurations will be listed. Select a configuration's check circle and the disk members of a volume, and then click **OK** to continue. The initialization of a RAID volume will take several minutes.

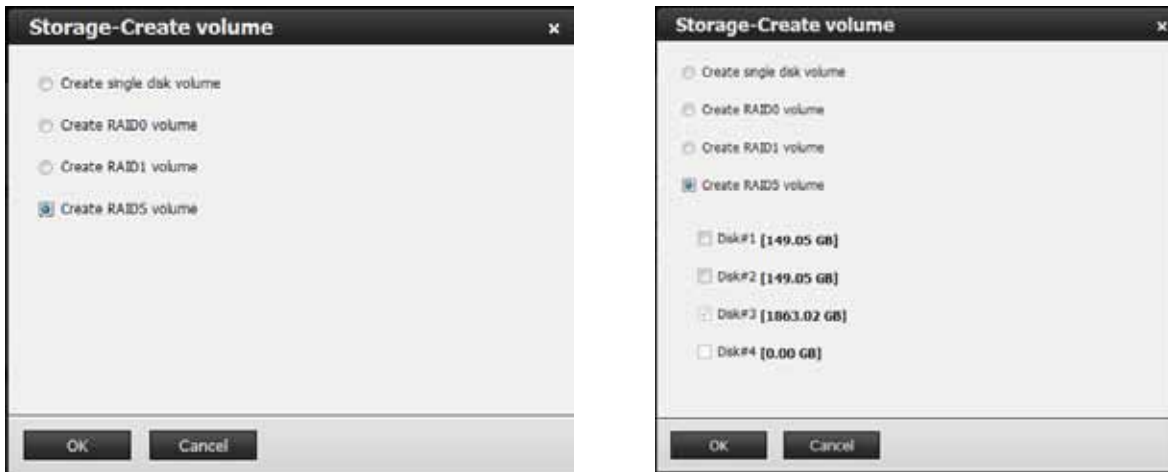

Please refer to page 82 for more information about Storage configurations.

10. The initialization process will be indicated as follows.

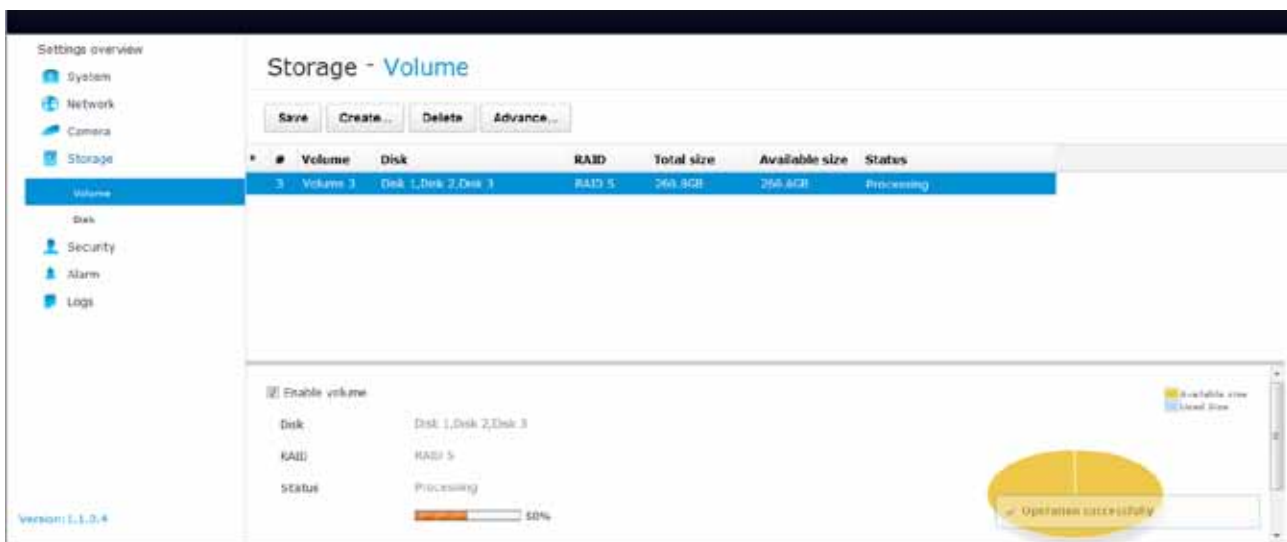

11. When done, the RAID volume details will be indicated on the **Volume** screen.



12. Click on **Camera > General** on the menu tree to open the camera settings page. Click on the **Search** button to locate cameras installed in the subnet.

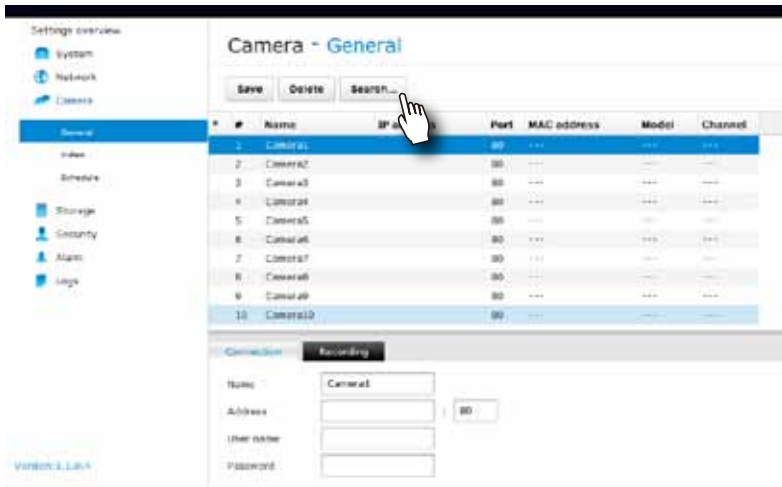

13. Cameras on the network will be listed. Click on the **+** button on the far left to enlist them into your configuration. Click **OK** when done on this page. Click **Save** when you return to the **Camera** page.

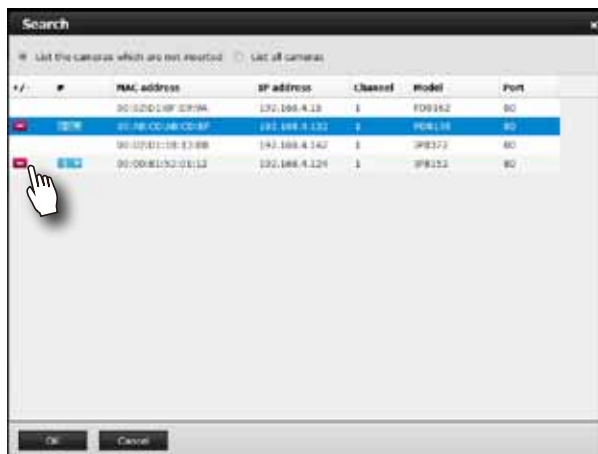

14. By default, cameras are configured to record all streaming at all time. You can change the recording settings in **Camera > Schedule**.

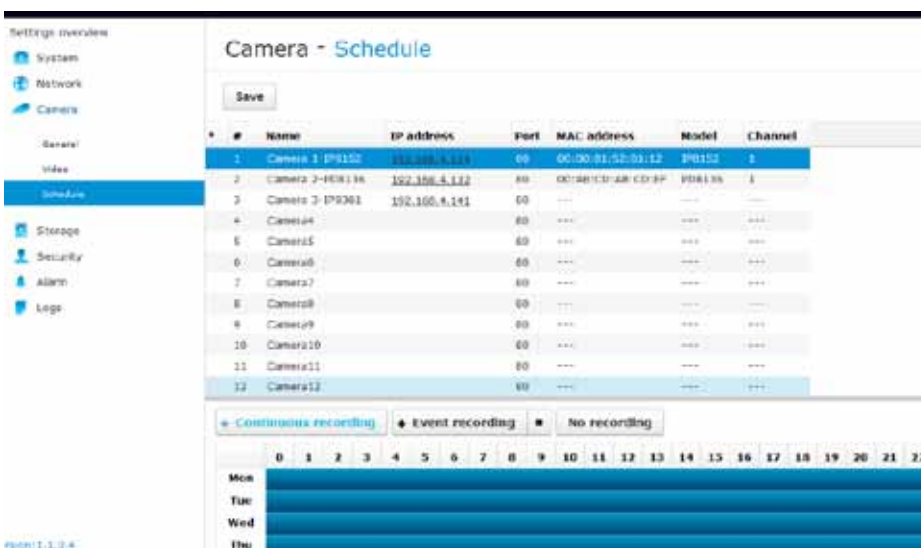

15. Refer to the following chapters for more operation and configuration details.

 **NOTE:**

If you need to install 4 hard drives,

1. Power down the system and disconnect the power cord.
2. Open the chassis top cover by removing 4 screws from the sides, and then the hand screw at the rear side of the chassis.
3. Remove the drive bracket by loosening 3 screws.
4. Orient the hard drive with its label side facing up and the connector side facing the front of chassis.
5. Connect the SATA connector and SATA power.
6. Secure the hard drive to the bracket by driving screws from the sides.

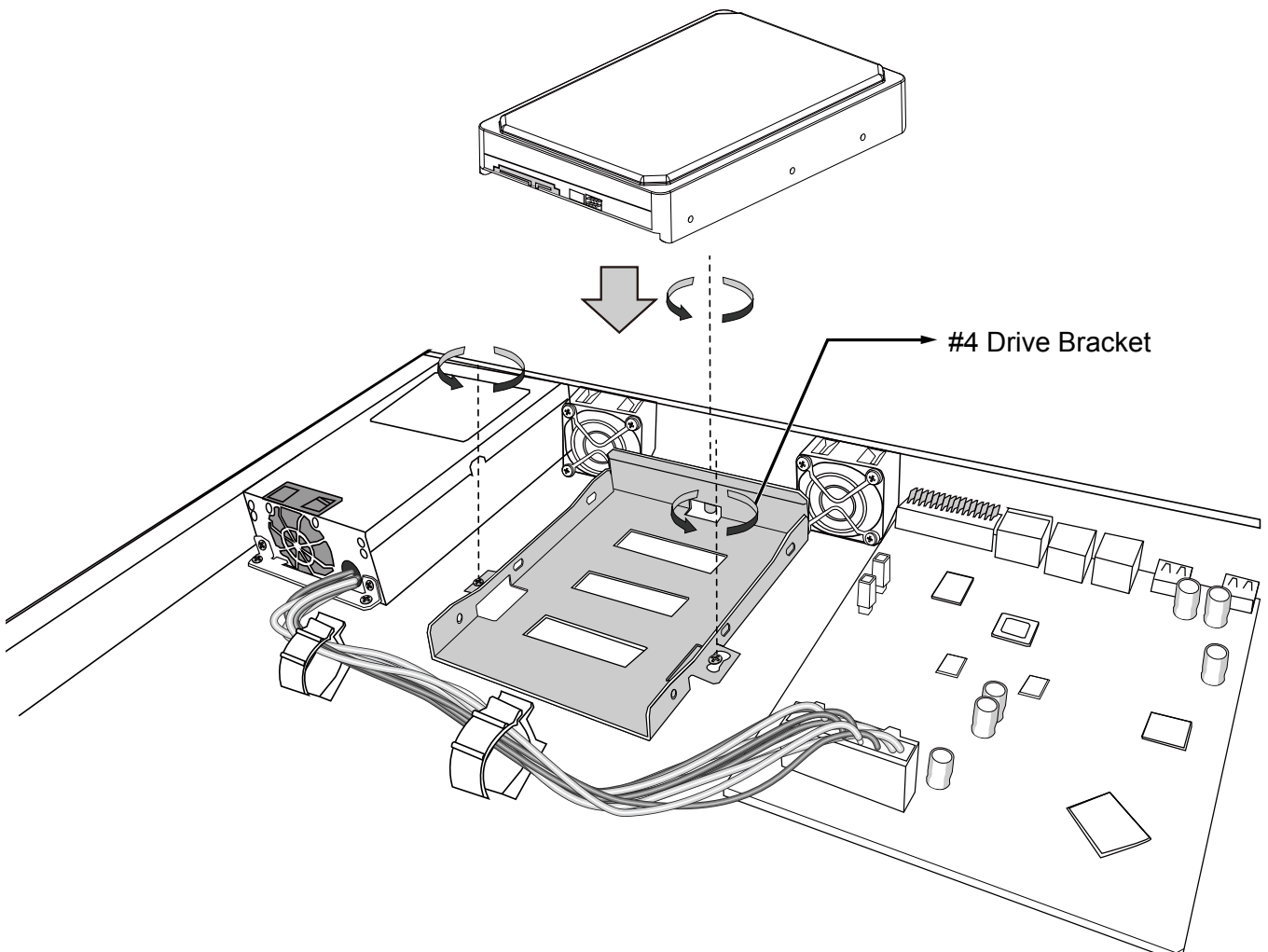

7. Install the drive bracket (along with the hard drive) back to the original location.
8. Re-install the chassis cover.

Rack-mounting

IMPORTANT:

If you have either a round-holed or square-holed rack, install cage nuts or clip nuts to the desired positions on the rack posts.

The instructions below are based on the installation to a 4-post equipment rack.

If you need to install the NVR system into a rack cabinet,

1. Install chassis ears to the sides of chassis using the included flathead screws. The rack-mount rails are separately purchased.

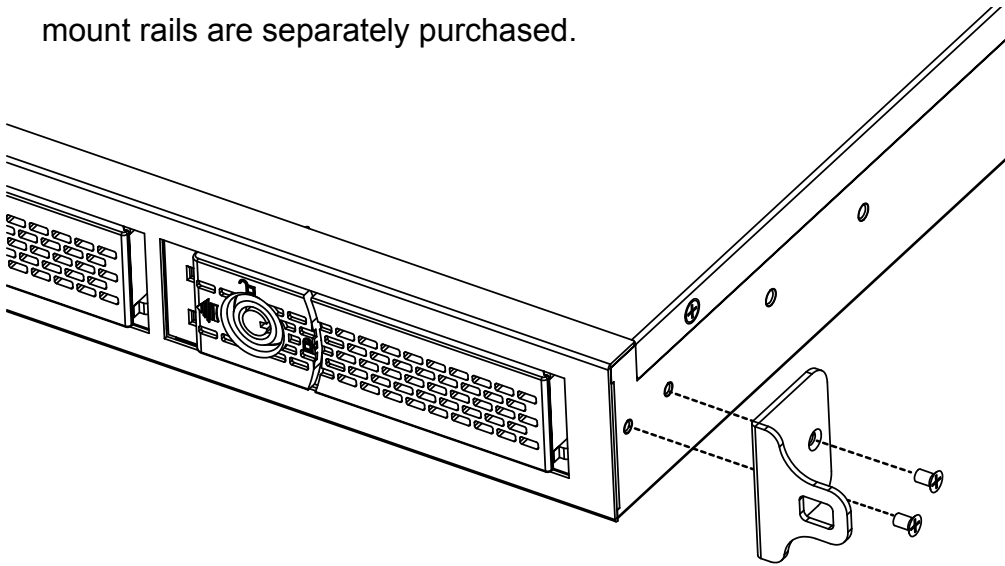

2. Unpack the rack-mount rails' package, and detach the inner rails from the rail assembly. Detach the inner rail by pressing on the release tab.

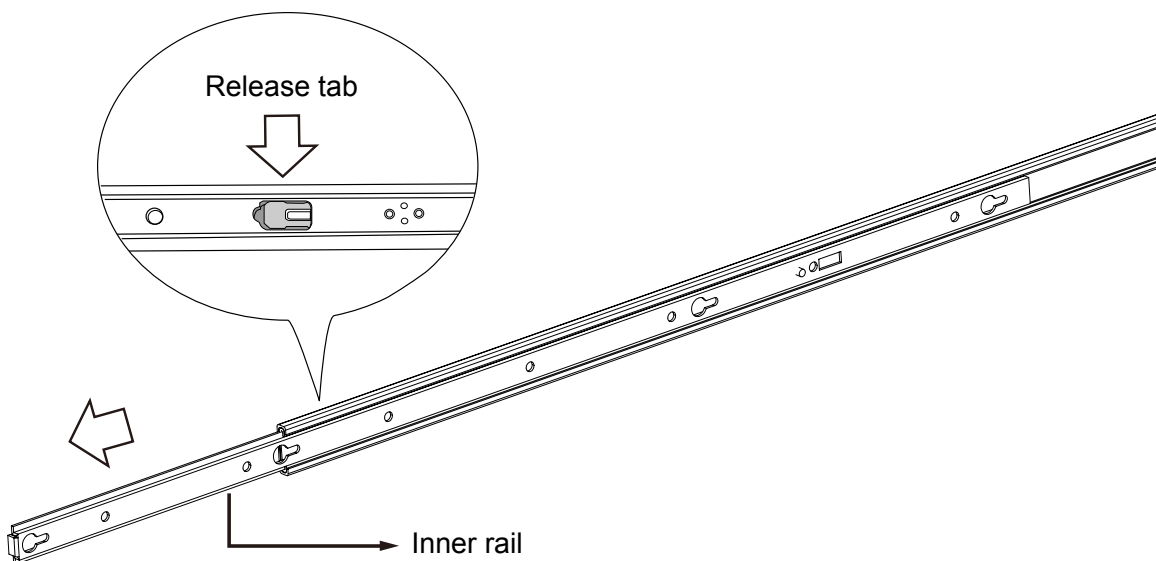

3. Secure the inner rails to the sides of the chassis using M4 screws.

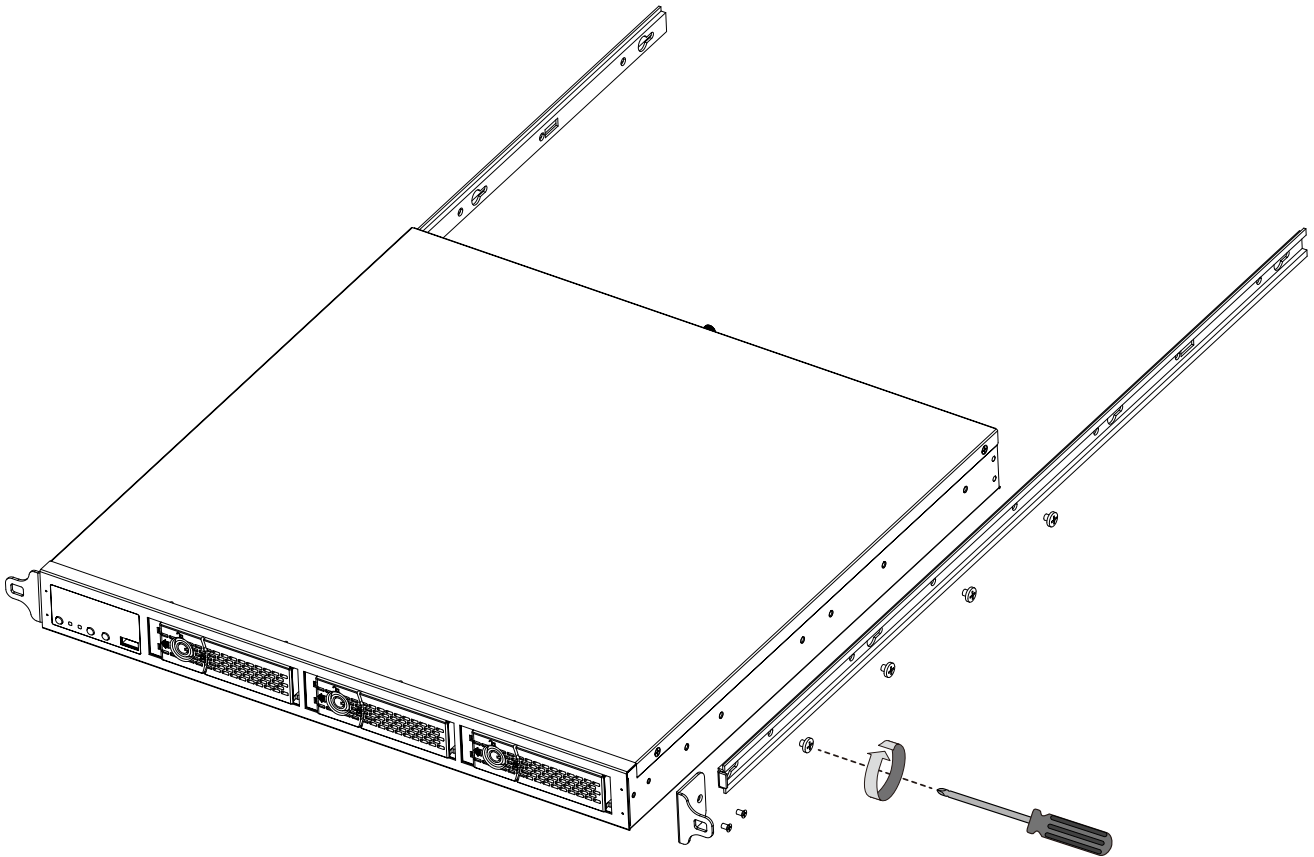

4. Secure the L-shape brackets to the front- and rear-ends of outer rails using the **black** round head screws and washers. Do not completely tighten the screws yet. Adjust the length of slide rails by extending and matching the rails between rack posts.

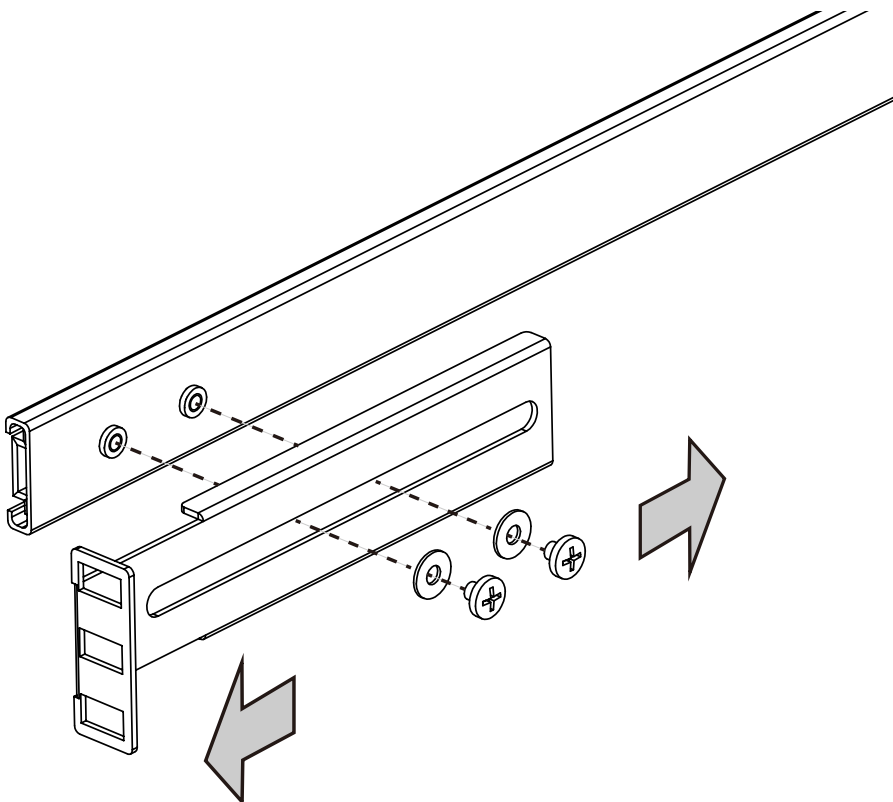

Adjusting the length of rails.

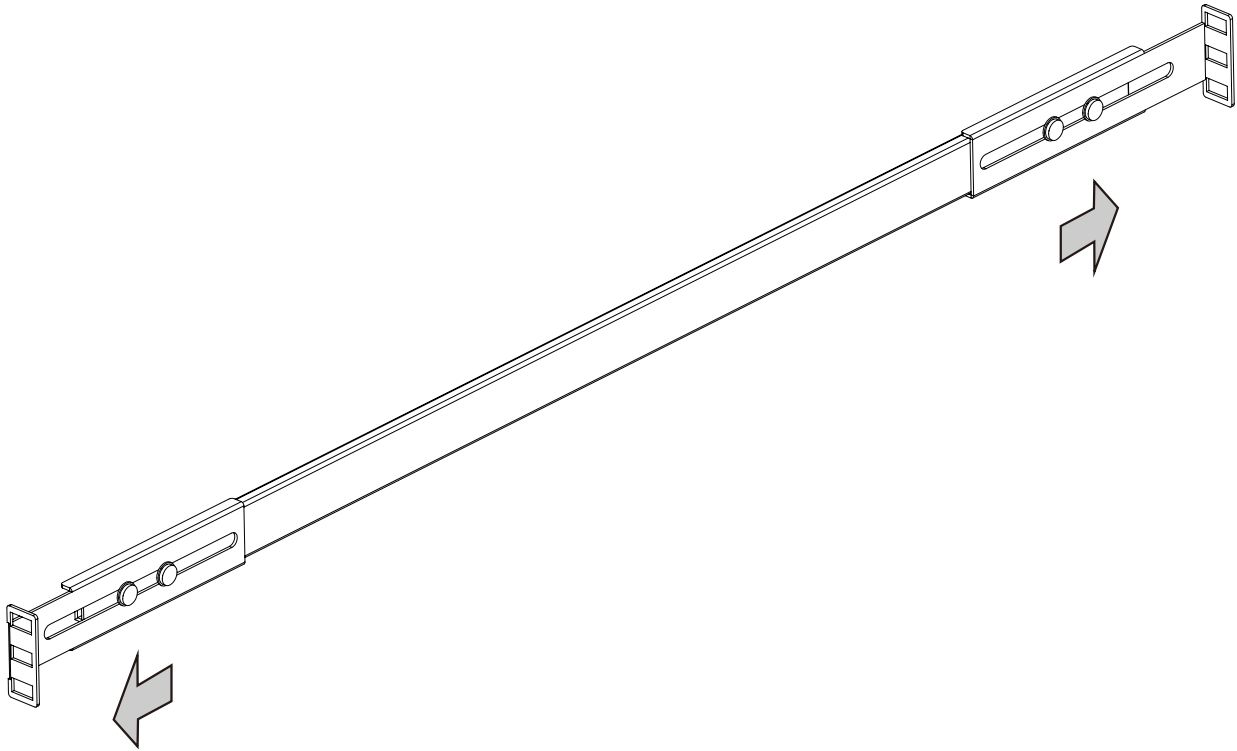

5. Secure the slide rails to rack posts using 8 M5 screws.

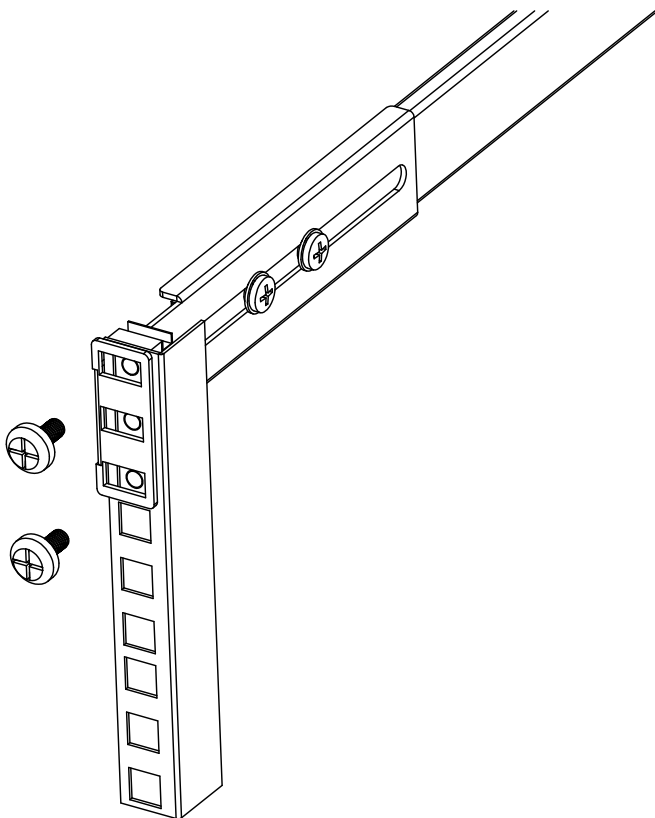



6. Hold the chassis using hands on the sides of the chassis. Align the inner rails on the chassis with the open portion of the slide rail assemblies. Push the system into the assemblies until the system stops.

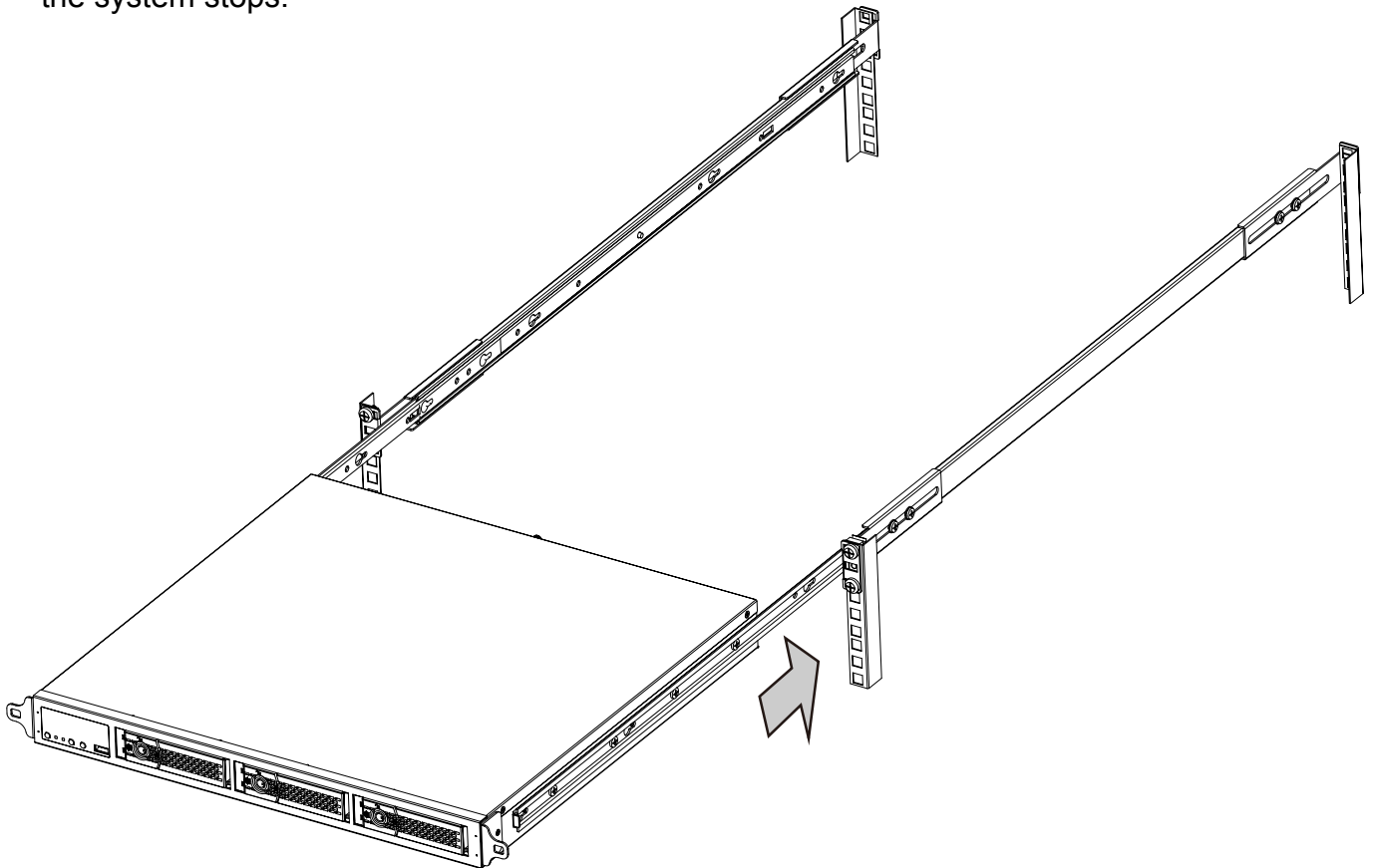

7. The inner rails and the rail assemblies should be locked on the way into the rack cabinet. Press the release tabs on the side to slide the chassis into rack.

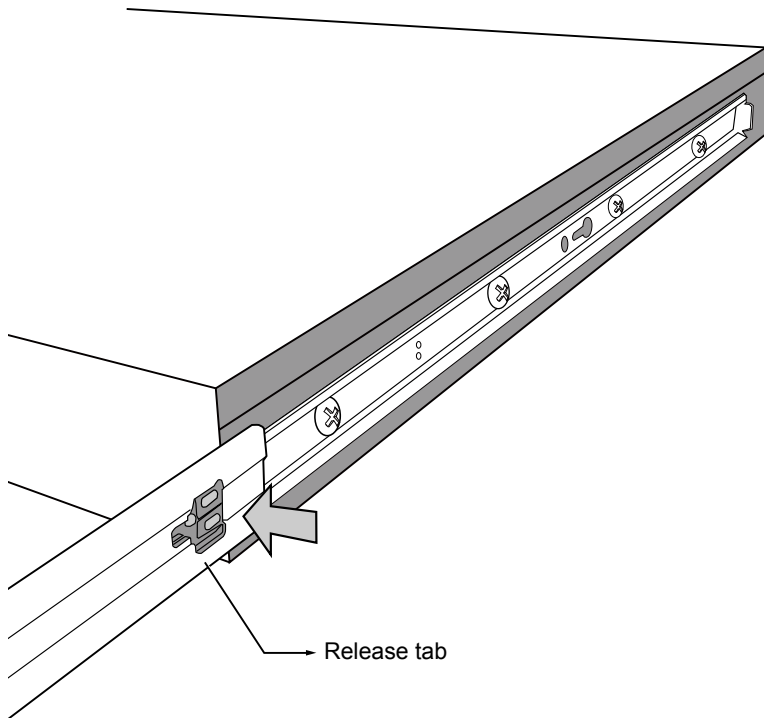

8. Secure the chassis to rack posts using a long M5 screw.

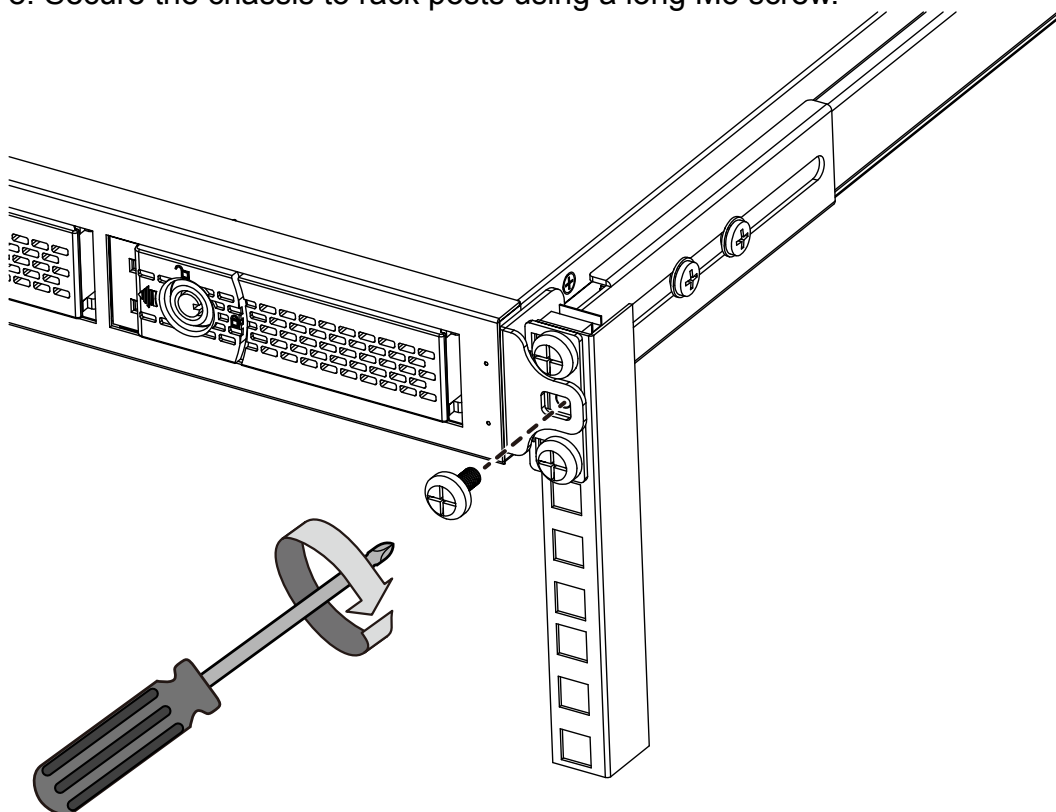

Attaching Foot Pads

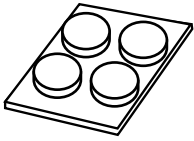

If you intend to place your chassis on a shelf or desktop, attach the foot pads to the bottom of the chassis where you can find corner marks for reference.

LED Indicators



| Name | Behavior | | Definitions |
|---------------------------|----------|-----------------|---|
| Power button LED | 1 | Off | Powered down |
| | 2 | Flashing Red | Powering on |
| | 3 | Constant Red | System is on |
| Status LED | 1 | Constant Green | System is ready |
| | 2 | Flashing Green | Bootting, proceeding with backup, restore, or restoring default |
| | 3 | Constant Orange | System errors, system buzzer will also be sounded |
| | 4 | Flashing Orange | Errors occurred with backup, restore, or restoring default |
| HDD LED | 1 | Constant Green | Recording software is up and running |
| | 2 | Flashing Green | Recording videos |
| | 3 | Flashing Red | Connection errors, cameras disconnected, or no volume is available. |
| Default button LED | 1 | Off | Not functioning |
| | 2. | Flashing Green | Restoring system defaults |
| Backup button LED | 1 | Off | Not functioning |
| | | Flashing Green | Backing up system configuration |

HDD tray LEDs

Volume status

Read/write status

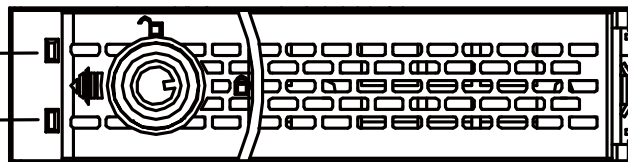

| | | | |
|------------------|---|----------------|---|
| HDD tray LED (2) | 1 | Constant White | Hard disks are ready and configured into a volume |
| | 2 | Off | No hard disk is present |
| | 3 | Flashing Blue | Read/write activities on hard disks |
| | 4 | Constant Blue | Drive is connected |

Power Up and Power Down

To power up and power down,

On the initial configuration:

1. Make sure the power switch on the rear panel is in the OFF (O) position, connect the power cord between the system and power outlet.
2. Turn on the system by turning the power switch to the ON (I) position.

After the initial connection,

1. Press the power button for 1 second to power on.
2. Press the power button for 1 second to power down. the system should start flushing the cache contents in system memory and gracefully shut down.
3. If the power-down sequence does not proceed normally, press the power button for 4 seconds to shut down.

WARNING:

1. No storage system is completely fail-safe. Damage to data might occur due to file system corruption, operating system malfunction, virus infection, HDD component failures, and so on. Therefore, it is highly recommended to regularly back up your data, and VIVOTEK disclaims responsibilities of data loss or recovery.
2. Always power off the system using the power button. Do not disconnect the power cord while the system is still operating. Doing so will result in data inconsistencies. The normal power-off procedure allows cached data to be written to disks.

NOTE:

If system buzzer is sounded, turn it off in **Settings > Logs > Error** page. Click the **Stop buzzer sound** button.

Serious system faults, such as a missing volume, can trigger the system buzzer. Verify the cause of system fault and turn off the buzzer.

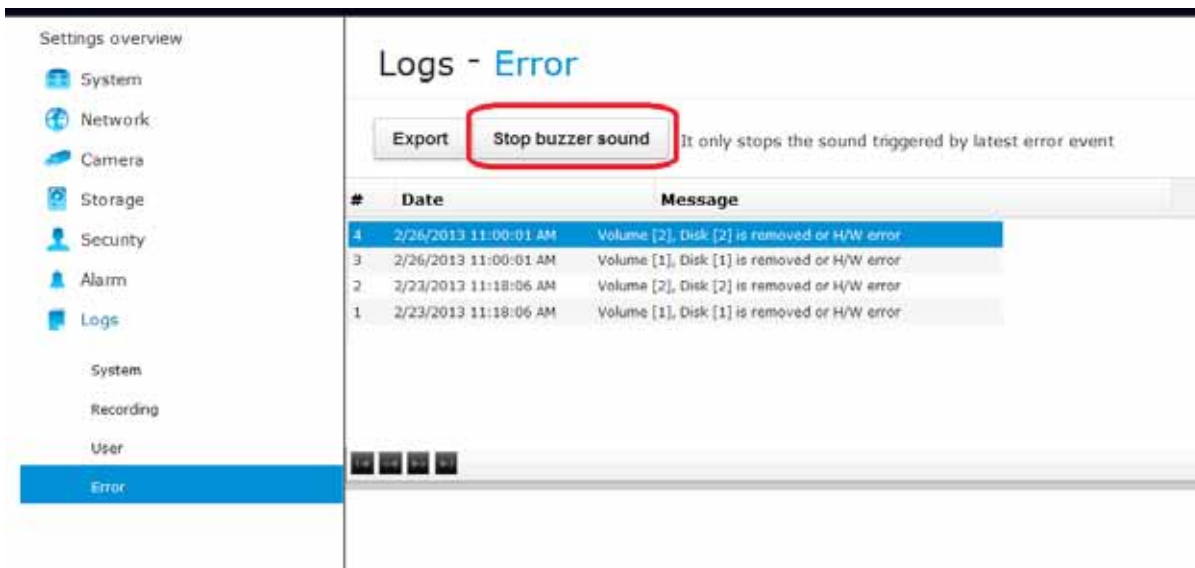

The screenshot shows the 'Logs - Error' page in the VIVOTEK web interface. On the left is a navigation menu with 'Error' selected. The main content area has a title 'Logs - Error' and two buttons: 'Export' and 'Stop buzzer sound'. The 'Stop buzzer sound' button is circled in red. Below the buttons is a table of error logs.

| # | Date | Message |
|---|-----------------------|--|
| 4 | 2/26/2013 11:00:01 AM | Volume [2], Disk [2] is removed or H/W error |
| 3 | 2/26/2013 11:00:01 AM | Volume [1], Disk [1] is removed or H/W error |
| 2 | 2/23/2013 11:18:06 AM | Volume [2], Disk [2] is removed or H/W error |
| 1 | 2/23/2013 11:18:06 AM | Volume [1], Disk [1] is removed or H/W error |

Chapter Two Login and Getting Started

2-1. Login

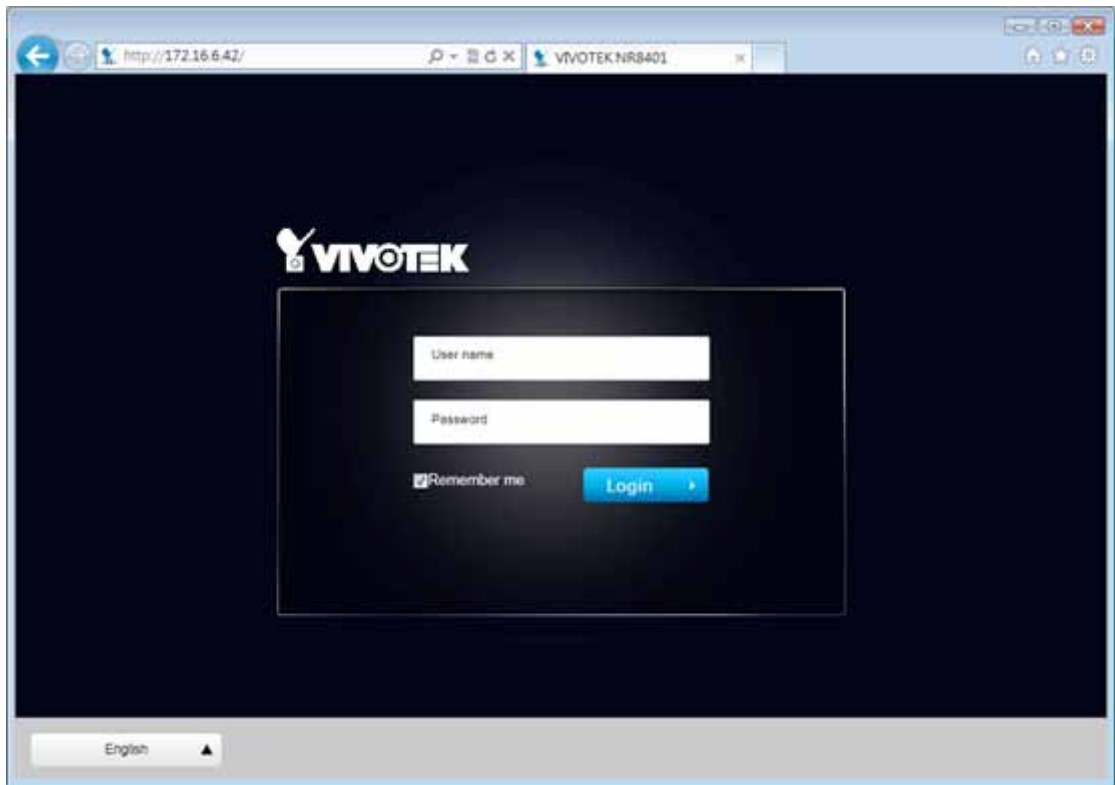

This is the login page on the browser. The minimum for resolution is 1280x960.

If you enable the IE7 compatible mode when using the IE8 browser, please disable the compatibility function.

It is highly recommended that you should change the default user name and password. Please refer to **Settings > Security > User account** page to see how to prevent unauthorized access. The system will prompt you if you entered an incorrect user name or password.

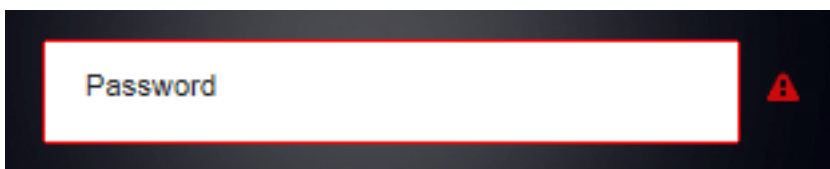

Remember me: Your user name will be preserved in browser cookies for two days if you select the Remember me checkbox. The user name will be automatically erased if you do not log in to the system for two days.

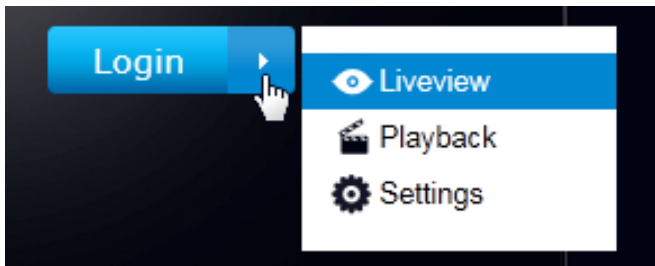

You may login to a different software utility by unfolding the side panel on the **Login** button.

You can also select a different language using the **Multilingual** selector menu on the **lower left** corner of the Login screen. The functional items, menus, and dialogues will then be displayed using the selected language.

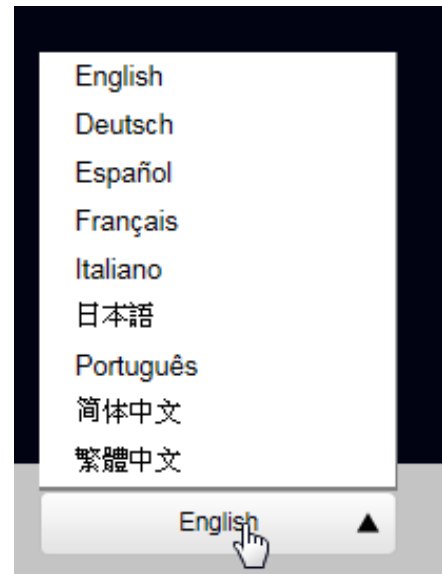

Remember me:

Select the checkbox to save your user name for use on the next login. The user name will be preserved in browser cookies for two days. If you do not login within the next two days, the user name will be erased.



Login errors: below are the login errors that might occur.

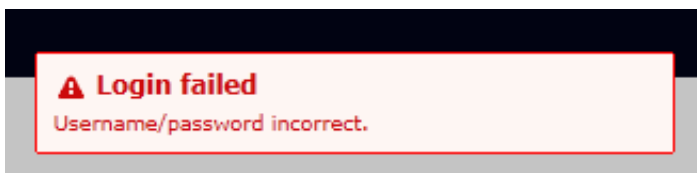

A Login failure can result from the incorrect user name and passwords.

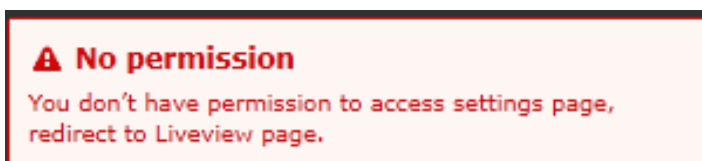

The No permission error occurs when a user logs in using an authentication that has no access rights to the Settings page. He will then be re-directed to the Liveview page.

Login options:

You may also mouse over the Login button to display the login options. You can then enter the Liveview, Playback, or Settings window.



The NVR system features a very simple UI structure which consists of a Liveview window, a Playback utility, and a system Settings window. Once logged in, you can move from one window to another by selecting the hot link buttons on the upper right of the screen.

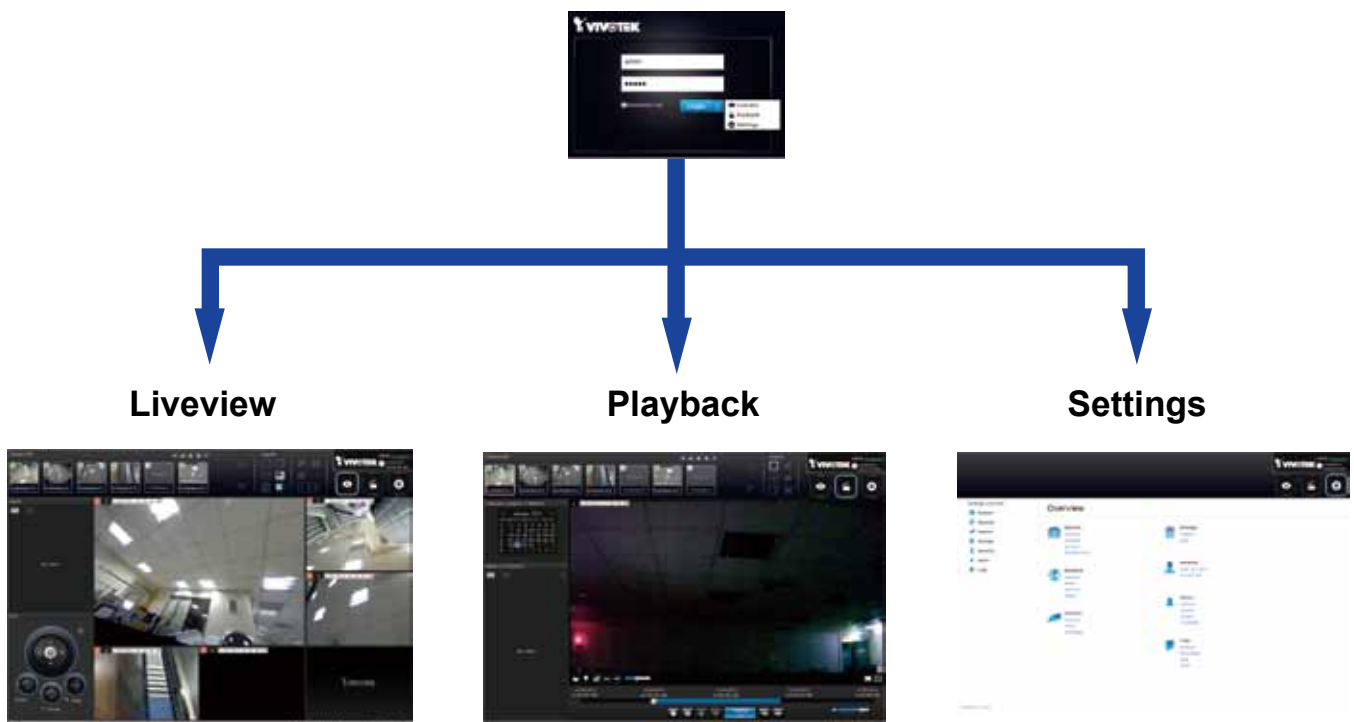

⚠ IMPORTANT:

1. Before operating the NVR, make sure you have properly installed hard drives and configured the storage volumes. Otherwise, you will not be able to operate or try some of the system's functionality.
2. Since the NVR system comes with 32-bit plug-ins for screen control, if your PC runs a default 64-bit IE browser and you manually enter the NVR's address on the browser, your browser session may malfunction. Instead, if you double-click on the discovered NVR on the IW2 utility, a 32-bit IE browser will open.
3. When you log in to the Liveview or Playback interface to stream a live or recorded video, install the ActiveX plug-ins. If it does not prompt when you log in, install plug-ins when you try to playback a recorded video. You may then need to re-start the IE browser console.

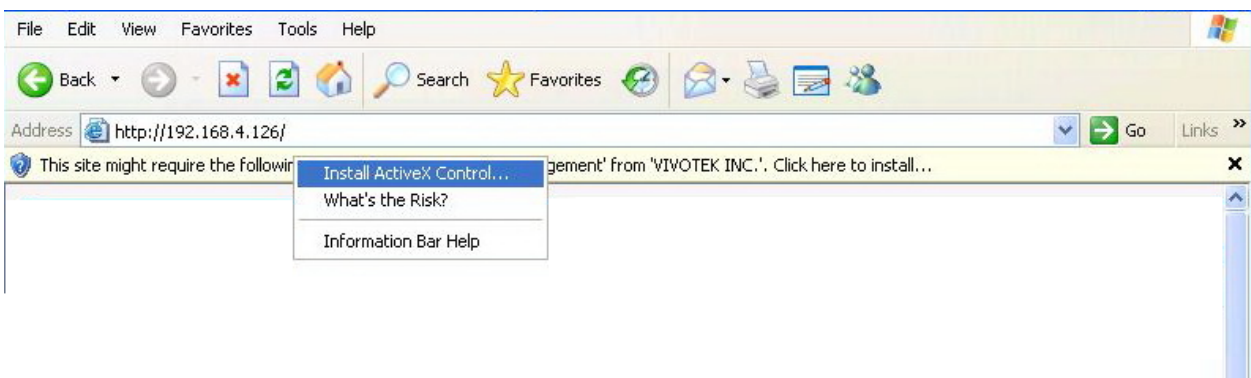

2-2. Graphical Layout and Screen Elements - Liveview

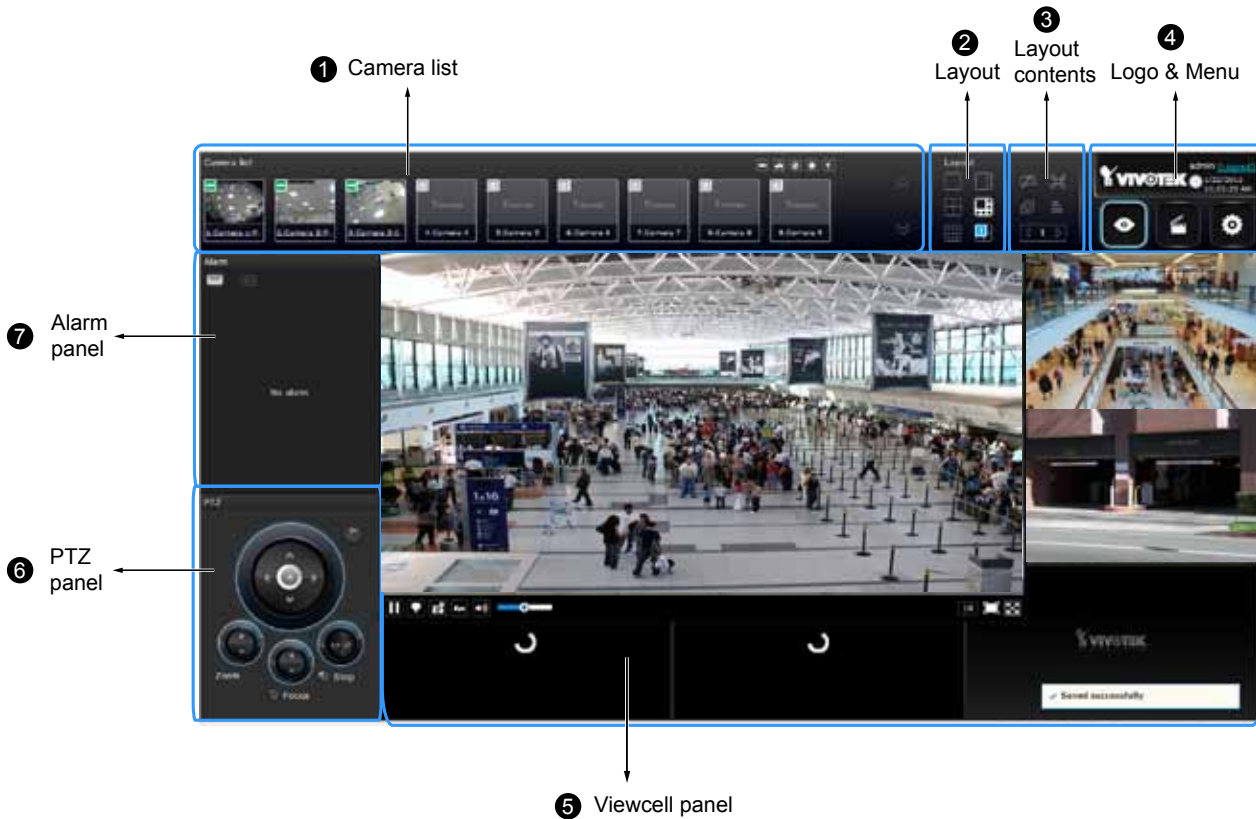

Once you log in, the system defaults to the Liveview page, which provides access to other configuration utilities, live view screen, and other functional panels. The screen elements are described as follows:

| Item | Name | Description |
|------|-----------------|--|
| 1 | Camera List | Provides a glimpse of all cameras inserted into your configuration. Basic information is also provided along with a screenshot. |
| 2 | Layout | Provides access to various layouts |
| 3 | Layout contents | Provides functions to extend, rotate, redo the layout, and control a DI/DO panel. |
| 4 | Logo & Menu | Provides access to the Playback and System Settings utilities, as well as system time and logout function. |
| 5 | View cell panel | Displays video streams from one or multiple cameras. Snapshot, streaming, bookmark, and audio control functions are also available on individual view cells. |
| 6 | PTZ panel | Exerts Pan/Tilt control on a selected view cell if the camera comes with mechanical PTZ mechanism. Note that the use of joystick is currently not available. |
| 7 | Alarm panel | Reports alarms transmitted via cameras' DI connections or those by the Motion Detection, etc. |

Each panel will be described in further discussions.

2-2-1. Camera List Panel

The camera list displays the 16 recruited cameras by the sequential numbering order you configured in the System Settings utility.

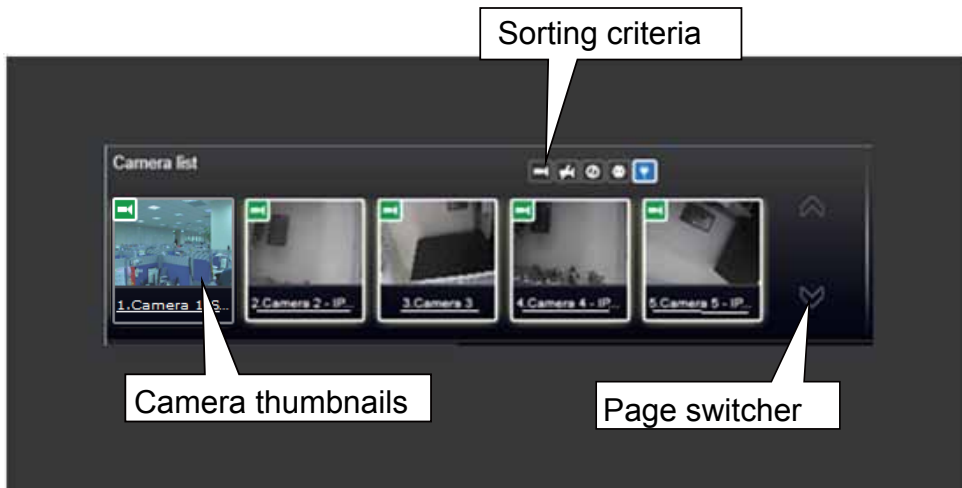

Depending on the size and screen resolution of your monitor, the snapshots of 5 or 9 cameras are displayed in this panel, and you should use the Page switcher buttons to see the rest of the cameras. If a user logged in using a credential of a limited access, he may only see cameras that he can access instead of all of the cameras.







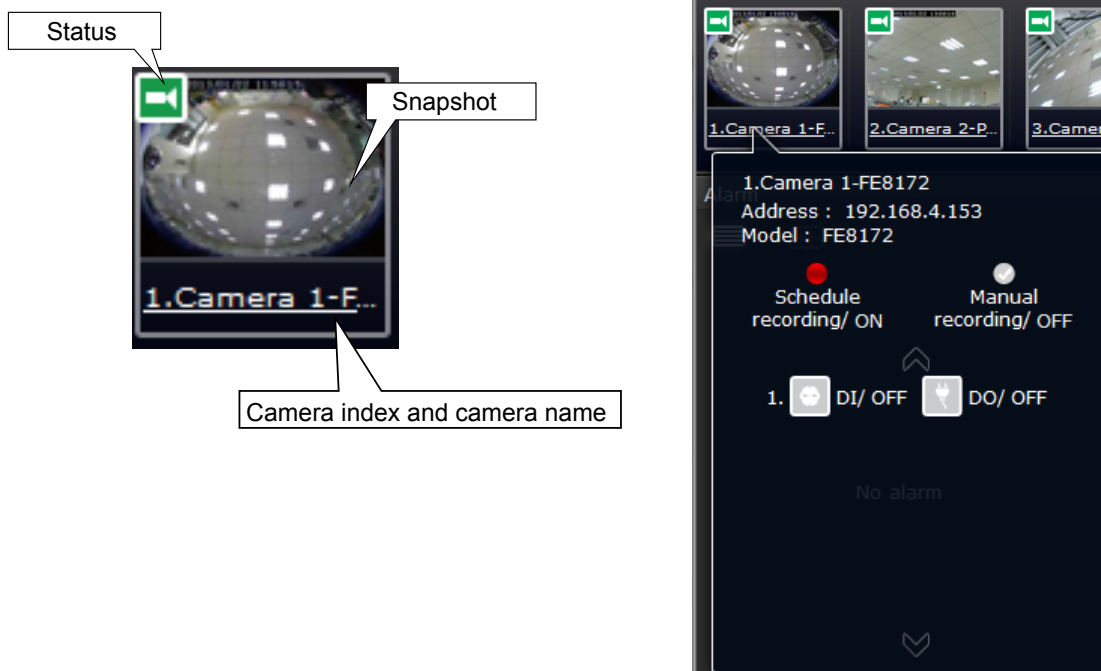

To arrange a view cell layout, users can click and drag a camera to a view cell. Once connected, a camera's video stream is displayed.

Camera Thumbnail:

A mouse click on the camera name under the thumbnail brings forth the summary of IP address, model name, recording setup and DI/DO information.



- * **Snapshot:** the camera's image snapshot is replenished every 5 minutes. If a camera is disconnected, the last image taken will be used to represent a camera.
- * **Camera index & Camera name:** Placing the mouse cursor on top of a camera text displays the camera index number and the camera name. You can click on the camera index to display the information box.
- * **Status:**





| | |
|---|--|
|  | Online: the online status can be accompanied by the DI/DO icon   |
|  | Offline: camera is disconnected. |
|  | An unconfigured camera instance |
|  | Digital input is triggered |
|  | Connected and recording video to system storage |
|  | Connected with live streaming |
|  | Disconnected or trying to establish a connection |

- * **Page switcher:** Moves to the next page on the Camera list panel. The button will be grayed-out if the end of the list is reached.



Sorting criteria









Use the sorting buttons to re-arrange the order of the cameras on the list. Cameras that match the condition will be brought to higher places on the list (front of the order) regardless of its original camera index.

| | |
|---|---|
|  | Online: the online cameras. |
|  | Offline: the offline cameras. |
|  | Unconfigured camera instance |
|  | Cameras whose Digital inputs have been triggered |
|  | Cameras whose Digital outputs have been triggered |

NOTE:



For online cameras, the snapshots on the camera list are refreshed by every 5 minutes, and therefore may not represent the latest occurrences on the surveillance areas.

2-2-2. Layout

| | |
|---|----------------|
|  | 1x1 |
|  | 1+3 |
|  | 1+5 |
|  | 2x2 |
|  | 4x4 |
|  | User layout #1 |
|  | User layout #2 |
|  | User layout #3 |
|  | User layout #4 |

By default, 5 typical layouts are provided for the user. They include: 1x1, 1+3, 2x2, 1+5, and 4x4. System default is the 4x4 layout. Cameras that do not fit into the first page of a layout, say, a 2x2 layout, will be displayed on the succeeding layout pages.

Each functional button on the screen is activated by a mouse hover. For example, the below states designate user's operation on a button:

1. : not selected.
2. : moused over, and is ready for selection.
3. : selected, and is taking effects.

Because the maximum number of supported cameras is 16, the fifth and sixth view cells on the 3rd page of the 1+5 configuration will be unusable.

Only an administrator can change and preserve a custom layout, and every user can designate a specific layout to be displayed when he/she logs in. The default layout for each user is stored in a browser's cookies.

Whenever changes are made to the current layout, a message prompt will appear on the side of the layout panel reminding you to save your current setting.

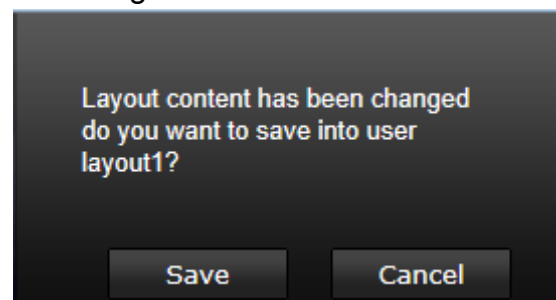

Note that a user who did not log in as an administrator can change a layout, but his configuration changes (with cameras inserted into view cells) **will not** be saved.





User Layouts



There are another 4 user layouts that can be individually configured. An administrator can insert camera views into these layouts, and save the configuration. These user layouts can be seen by all users. If you click the **Rotate** button before the configuration changes can be saved, your configuration changes will be lost.

2-2-3. Layout contents

A few functional buttons are available on the Layout contents page.

| | |
|---|---|
|  | Clears all view cells on the current layout |
|  | Full view: extends the view cells on the current layout to the full of the screen. |
|  | <p>Rotate: the rotate function lets system display successive layout pages by the intervals of 10 seconds. The layout page that does not contain camera views will be skipped.</p> <p>A Rotate action will stop when you</p> <ol style="list-style-type: none"> 1. move to another page, 2. move to a user layout, 3. click to select a view cell, 4. remove a camera from view cell. |
|  | DI/DO: displays the DI connection statuses and allows users to manually trigger a DO signal. |
|  | If your current layout spans across multiple pages, use the arrow buttons to switch from one page to another. The index number of the current page will be shown between the arrow buttons. |

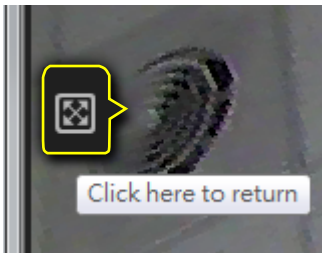

When your current layout is displayed in a full view, move your cursor to the left center of the screen to return to the default Liveview screen. The **Return** button will appear.

2-2-4. Logo & Menu

A logout button, system time panel , and 3 hot link buttons to access the **Liveview**, **Playback**, and **System Settings** utilities.



The system date and time refers to the date and time kept on the NVR system's real time clock.

Due to the limited space for the user name, user name may be partially displayed until you hover your mouse cursor.

IMPORTANT:

Your configuration changes will be lost if you click one of the hot link buttons to move to another utility window. For example, you have changed your Live View layout and then click on the Playback button, you will enter the Playback window without saving your configuration. **Save your changes before you use these buttons.**

2-2-5. View Cell panel

A single view cell is shown below. Each view cell contains a video stream display area, an information bar, and functional buttons at the bottom. A view cell is displayed in Normal, Focused, or Maximized mode.

1. **A single click** selects a view cell from the View Cell panel, enables its function buttons, and turn it into the Focused mode.
2. **The 2nd click** maximizes the size of the view cell to the full of the panel.
3. **The 3rd click** shrinks the maximized view back into the focused mode.



To deselect a view cell and return to the normal view, click on the **Restore**  button at the lower right of the window.

Adding Cameras to View Cells

1. Click and drag a camera from the camera list to an unoccupied view cell.
2. Double-click a camera on the camera list. The camera will be added to the first unoccupied view cell.

To deselect a view cell and return to the normal view, click on the **Restore** button at the lower right of the window. You can also click on another view cell to continue adding other cameras.

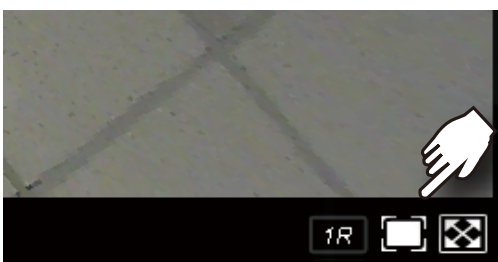

A view cell attempting to connect to a network camera will look like this. If the connection attempt takes a long time, it may result from network problems or incorrect configuration with video streaming. For example, you may have configured the camera to be streaming channel #2 using the **MJPEG** mode, which is not supported by the system. The NVR uses video stream #1 for recording, and stream #2 from cameras for live viewing. You should then open an individual web console with the network camera to change its video streaming configuration.

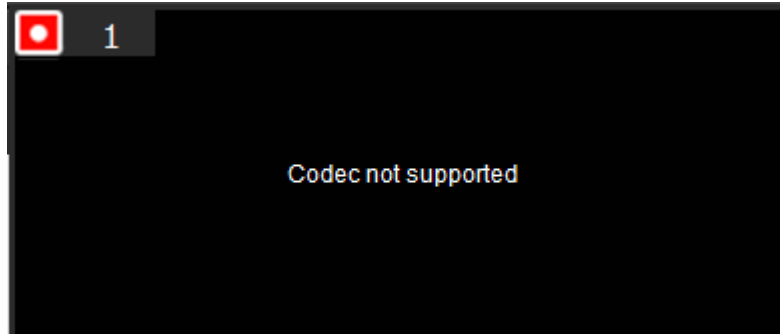

⚠ IMPORTANT:

A camera can be inserted into multiple view cells. This way, a camera with a wide field of view, such as a fisheye camera, can simultaneously display different regions of interest in different view cells.

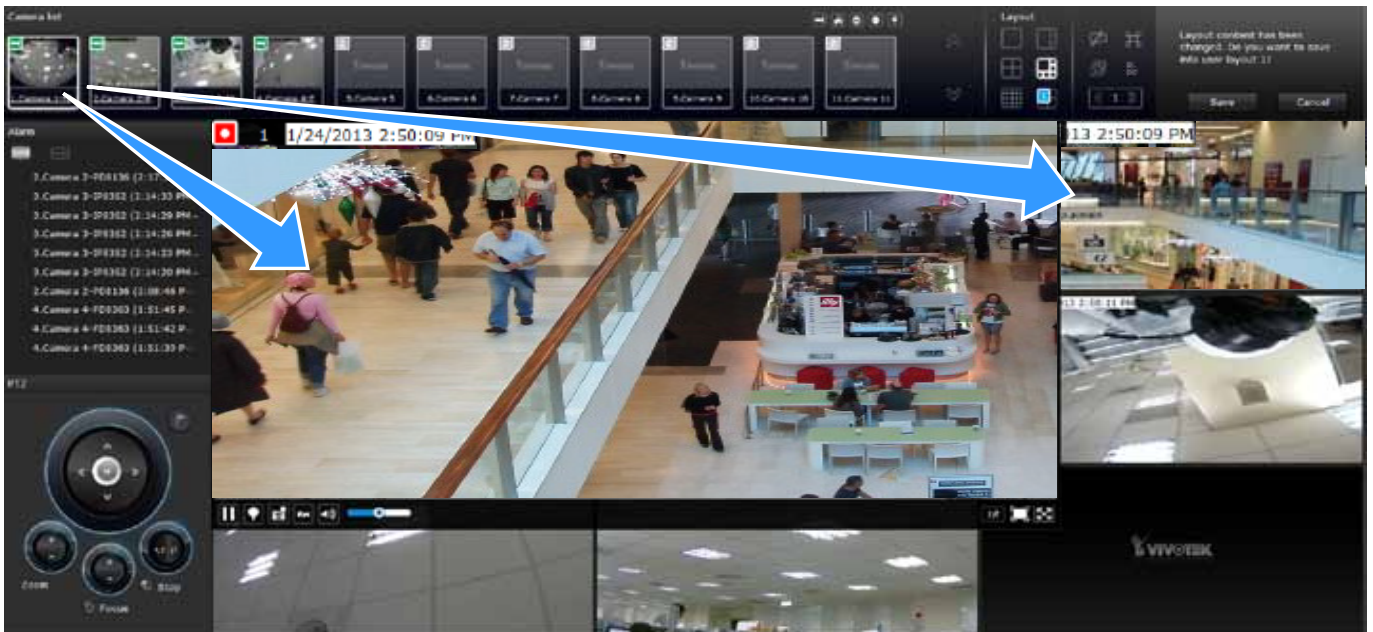

If the current layout already contain 16 cameras, the following message will prompt.

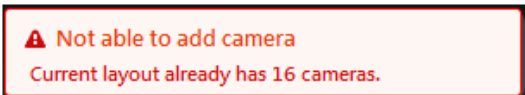

There can be more than 16 view cells across multiple layout pages, e.g., on the third page of the 1+5 layout. Placing a camera in the 17th or 18th view cell will bring out the following message.

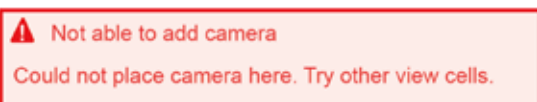

Information Bar

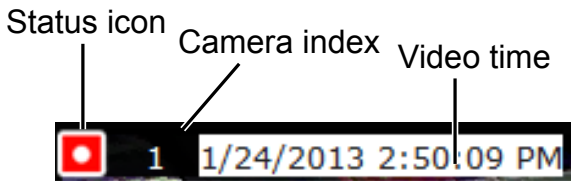

| Status icon | Description |
|-------------|--|
| | Connected with live streaming; a single click on this icon can trigger a manual recording. |
| | Connected and recording video to system storage. |
| | Disconnected or trying to establish a connection. |



NOTE:

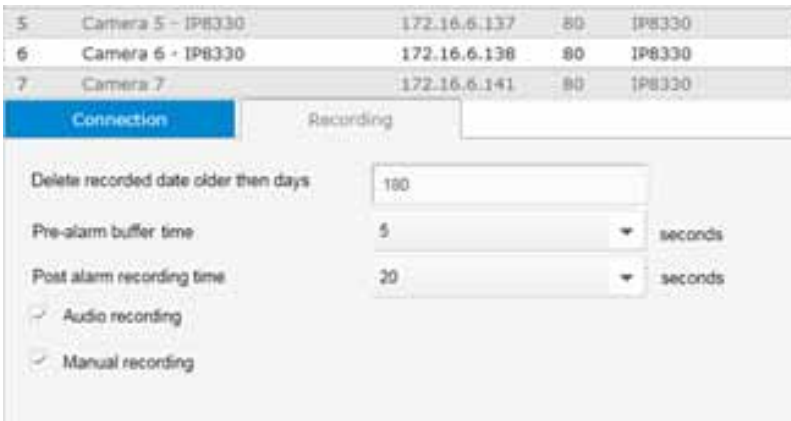

If you disable the **Manual recording** function on the **Settings** page, you will not be able to use the Manual Recording function on the Liveview.

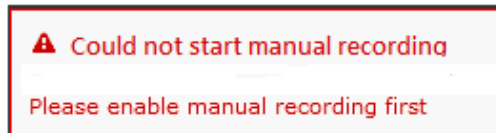

A mouse hover over the status icon will produce the following messages:

| | |
|--|--|
| 1. "Connecting..." or "Cannot connect" | Connecting to a camera, or connection problem might have occurred. |
| 2. "Live streaming" | Video is being streamed. |
| 3. "Recording" | Currently recording the video stream. |

Camera index: an index number appointed to a camera following the order you inserted cameras during the initial setup.

Video time: The time configured on the NVR system is displayed here.



The time display formats are slightly different for different languages:

| | | | |
|-----------|------------|--------------------------|----------------------|
| English | M/d/yyyy | H:mm:ss AM/PM | 5/3/2011 1:07:05 AM |
| Deutsch | yyyy/MM/dd | HH:mm:ss | 03.05.2011 01:07:05 |
| Español | yyyy/MM/dd | HH:mm:ss | 03/05/2011 1:07:05 |
| Français | yyyy/MM/dd | HH:mm:ss | 03/05/2011 01:07:05 |
| Italiano | yyyy/MM/dd | HH:mm:ss | 03/05/2011 01:07:05 |
| 日本語 | yyyy/MM/dd | H:mm:ss | 2011/05/03 1:07:05 |
| Português | dd-MM-yyyy | HH:mm:ss | 03-05-2011 01:07:05 |
| 简体中文 | yyyy/M/d | H:mm:ss | 2011/5/3 1:07:05 |
| 繁體中文 | yyyy/M/d | tt hh:mm:ss tt 為上午/下午 | 2011/5/3 上午 01:07:05 |

Tool Bar Buttons



| Buttons | Description |
|---------|---|
| | Resumes streaming. |
| | Pauses a video stream. |
| | Adds a Bookmark (that saves a short description and a one-minute footage from the current feed) |
| | Takes a snapshot. |
| | Removes camera from the view cell. |
| | Mutes (if there is audio input from the camera.) |
| | Unmutes |
| | Restores the view cell's original position on the Liveview panel. |
| | Maximize the size of current view cell. |
| | Activates the PiP function. |
| | Disables digital zoom (PiP). |

| Buttons | Description |
|---|--|
|  | Volume controller |
|  | <p>Fisheye display modes - if the view cell contains video from a fisheye camera, the fisheye display mode selector will be available:</p> <p>1O: the original circular view. 1P: the panoramic view. 1R: the regional view.</p> <p>Please refer to the fisheye camera's User Manual for more information.</p> |

Tool Bar Functions in Details

1. Play and Pause buttons:

These buttons pause and resume a video stream currently being played on your web browser. Note that this operation does not affect the video recording taking place between a camera and the NVR system.

2. Bookmark:

This function allows you to place a bookmark on a recorded stream when you observe a situation from your live view window. The bookmark is preserved as a one-minute footage along with a short description of a particular incident. The precondition of using this function is that the video stream, while you are watching it on the view cell, must be recorded to the NVR at the same time.

To add a bookmark,

1. Click on the button,
2. Enter a short description that can be as long as 120 characters.



3. A confirm message will prompt at the lower right of the screen.

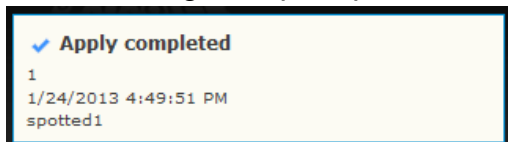

If the current video feed is not being recorded to storage, you will receive the following message:

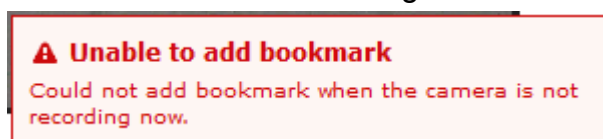

Errors with creating bookmarks may also result from network and server errors.

Below are two bookmarks (yellow tags) shown along with a recorded video in the Playback utility screen. Bookmarks help find and retrieve important moments in a recorded video.

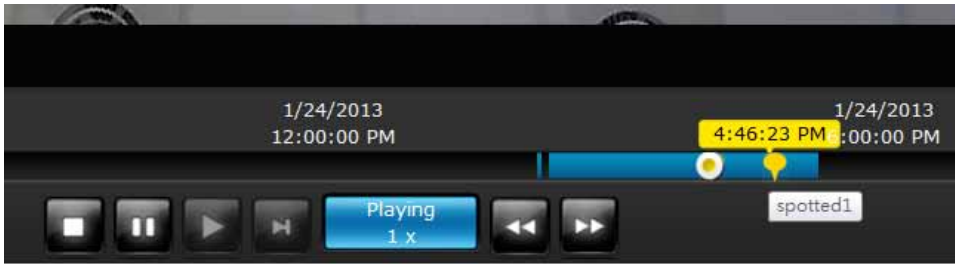

 **NOTE:**

Bookmarks will be erased if the user/system erases the video clips they were appended to. For example, system will recycle storage space by deleting old videos along with their bookmarks.

3. Snapshot: 

This button produces a snapshot prompt. You may then right-click on the snapshot image to save it to a preferred location.



Note that the size of a snapshot is equal to the frame size set for the video stream.

4. **Clear:** 

This button removes camera from the current view cell. The view cell will then be available for other cameras

5. **Mute and Unmute:** 

These buttons stops or resumes audio from a live stream.

6. **Restore:** 

This button restores the view cell's original position on the Liveview panel.

7. **Maximize:** 

This button extends the size of current view cell to the full of the Liveview panel.

8. Activate and Deactivate **PiP** function: 

PiP is short for **Picture in Picture**, a function that provides digital zoom into a live video. When activated, a Global view window will appear at the lower right of the view cell as shown below. You can display only a portion of the complete video frame as an area of your interest. Using a click and drag on the ROI window, you can instantly move to other areas within the video frame.

You can resize the ROI window by a mouse hover on the lower-right corner of the window until the resize mark appears. The default size of the ROI window is 25% of the Global view.

Click on the deactivate  button to close the PiP window.

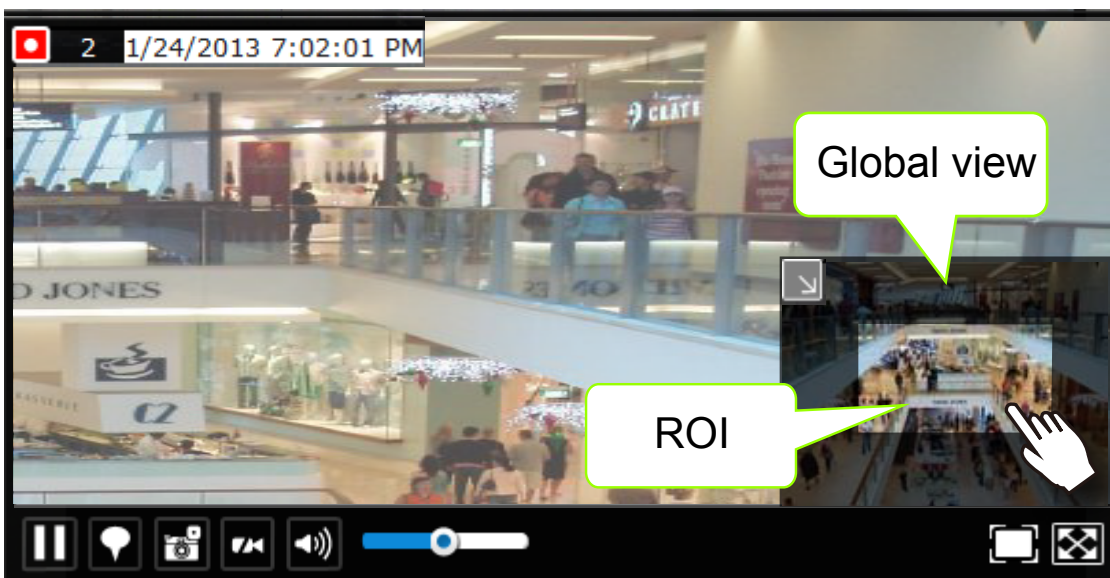

Note that not every camera supports the PiP function. For example, the fisheye series cameras do not support this feature.

 **NOTE:**

The Talk function in the two-way audio is currently not supported.

9. Volume controller:



The volume control takes effect when audio input from the network camera is available. Audio is heard only from a focused window, one that you selected by a mouse click from the Liveview panel. Some network cameras do not come with an embedded microphone, and its audio is disabled by system default. The actual sound level is also dependent on the system volume of the PC having a web console with the NVR.

The sound volume configuration will not be preserved when a camera is removed from a view cell, web console is restarted, or when the Liveview layout is re-configured.



10. Fisheye display modes:

A view mode selector icon appears in a view cell of a fisheye camera. You can click to select a viewing mode. The viewing modes are illustrated as follows:

1O (Original view)

1O View (Original View)

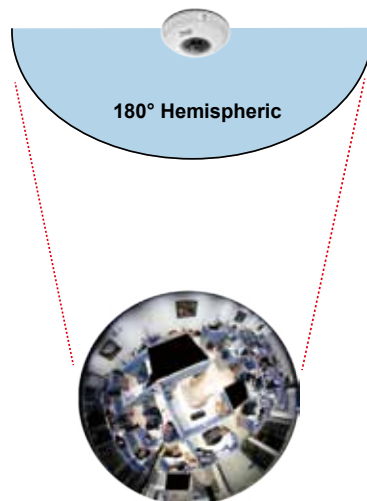

1P (Panoramic view)



1R (Regional view)

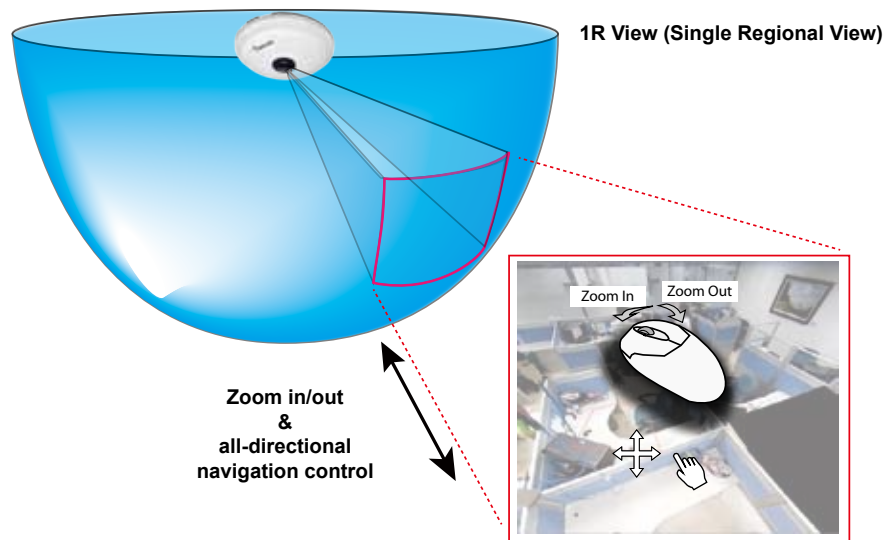

The 1R mode (or rectilinear) provides access to one image section within the hemisphere. You can zoom in or out (using the mouse wheel or PTZ panel) or travel through to other areas within the hemisphere using simple mouse clicks and drags. A single click on a particular object can bring the object to the center of your view window. Click and hold down the left mouse button, and you can swipe the view both horizontally and vertically.

Note that if your fisheye mounting type is set to the **Wall Mount** type, your screen control in the view cell will be limited to 90° pan and tilt. Make sure your mounting type and camera settings have been properly configured.

Because fisheye lens can cover a wide surveillance area, you can insert a fisheye camera into multiple view cells, and let different regional views display in these view cells. In this way, you can have a glimpse of multiple areas of interest, and the configuration of these different view windows will be preserved when you save your layout settings.

2-2-6. PTZ panel

The PTZ panel takes effect for cameras that come with mechanical PTZ functions. It does not support digital PTZ functions. To utilize its functions, select a view cell populated by a PTZ camera, such as a speed dome.

Depending on the individual functions that come with PTZ cameras, some functions will not be available for every cameras. For example, the zoom controller will not apply for a PTZ camera that comes without a mechanized zoom module, such as PD8136 and PT8133.



Listed below are the camera models and the types of supported PTZ controls:

| Model (series) | Pan/tilt controller | Preset location | Zoom controller | Focus controller | Auto Pan/Patrol controller |
|-----------------------------|---------------------|-----------------|-----------------|------------------|----------------------------|
| PT | Yes | Yes | No | No | Yes |
| VS (VS8102 and earlier) | * Depends | Depends | Depends | Depends | No |
| VS84xx/88xx | Depends | Depends | Depends | Depends | Depends |
| PZ series | Yes | Yes | Yes | Yes | Yes |
| SD8xxx | Yes | Yes | Yes | Yes | Yes |
| SD7xxx | Yes | Yes | Yes | Yes | Yes |
| IP7xxx/8xxx box camera | Depends | Depends | Depends | Depends | Depends |
| IP6xxx/3xxx/2xxx box camera | No | No | No | No | No |
| IZ series | Depends | Depends | Yes | Yes | Depends |

* If the analogue cameras connected through the video server support PTZ mechanism.

NOTE:

On the the Liveview window, currently the **Continuous Move** and the **Click-on-image** functions for PTZ cameras are not supported. Neither can you zoom in/out using the mouse wheel.

PTZ presets: If your PTZ cameras have preset locations, click on the button to unfold the preset menu. Click on any of the preset locations to move to the area of your interest. Refer to your camera's User Manual for how to configure preset locations.

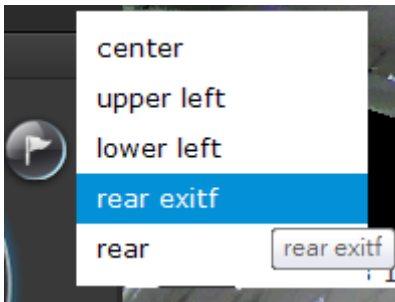

The following message will prompt if the camera has no preset locations.

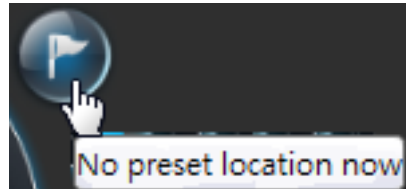

Pan/Tilt controller: A mouse hover over the arrow buttons activates the arrow button. Use the buttons to navigate to a preferred location.



Zoom controller: The zoom controller buttons only apply to cameras that come with an optical zoom module, such as a speed dome camera.



Focus controller: The focus controller buttons apply to cameras that come with focus control over its lens module, such as a speed dome camera.

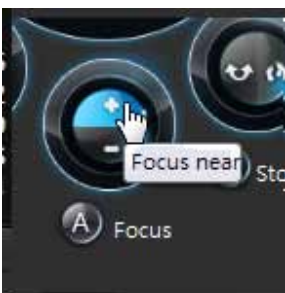

Auto Focus: If your camera supports the auto focus function, use this button to acquire an optimal focus point.

Auto pan/patrol controller: These buttons provides pan and patrol functions provides that preset locations have been configured on the camera. For a speed dome camera, the pan command tells the camera to continuously pan 360 degrees until stopped by a user command. For PZ or PT series cameras, the pan action only takes place once to cover reachable areas.



The **Stop** button ends a pan or patrol tour.

2-2-7. Alarm panel

To receive alarms from cameras, you need to configure alarm triggers in the **Settings > Alarm** configuration window (see page 99). Network cameras' digital inputs, digital outputs, or motion detection, or NVR's digital inputs can all be used to detect conditions in external environments. When the alarms are triggered, you can configure certain kind of actions to take place in response to the alarms, such as:

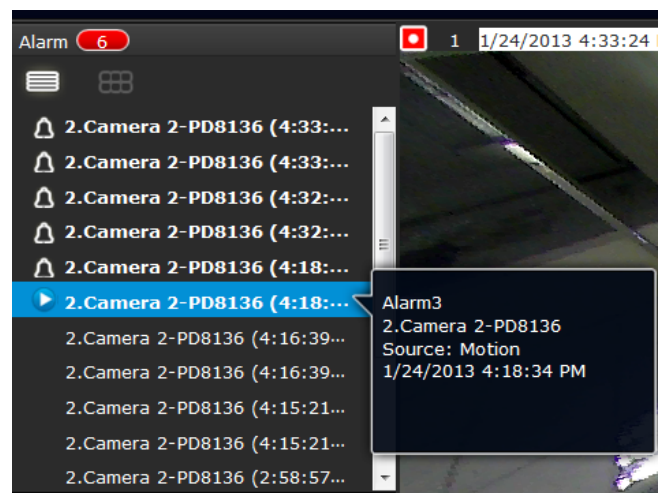

1. **recording** the immediate video,
2. sending an **Email**,
3. sounding the **buzzer**,
4. sending snapshots to an **FTP server**,
5. sending event messages to **web server**,
6. moving camera lens to a **preset** location,
7. triggering an NVR/camera **digital output**.

The alarm panel displays the latest 10 alarm entries with the latest alarm on top of the list. The alarm list keeps up to 200 events. Older events will be erased if the number exceeds 200.



The alarm panel is polled every 10 seconds. A mouse hover on an alarm entry displays full information of the event.

Note that multiple alarms can be triggered by one incident. See page 99 for how to configure the alarm settings.

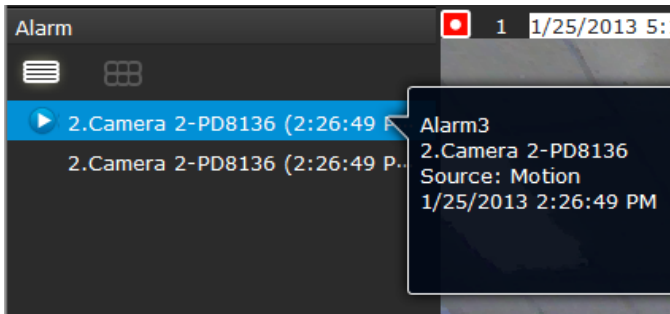

The alarm panel is displayed either in the list mode  or the icon mode .

If an event is configured with a recording action, or the alarm is triggered when the associated camera was recording to the NVR, there will be a play button to the left of the alarm message.

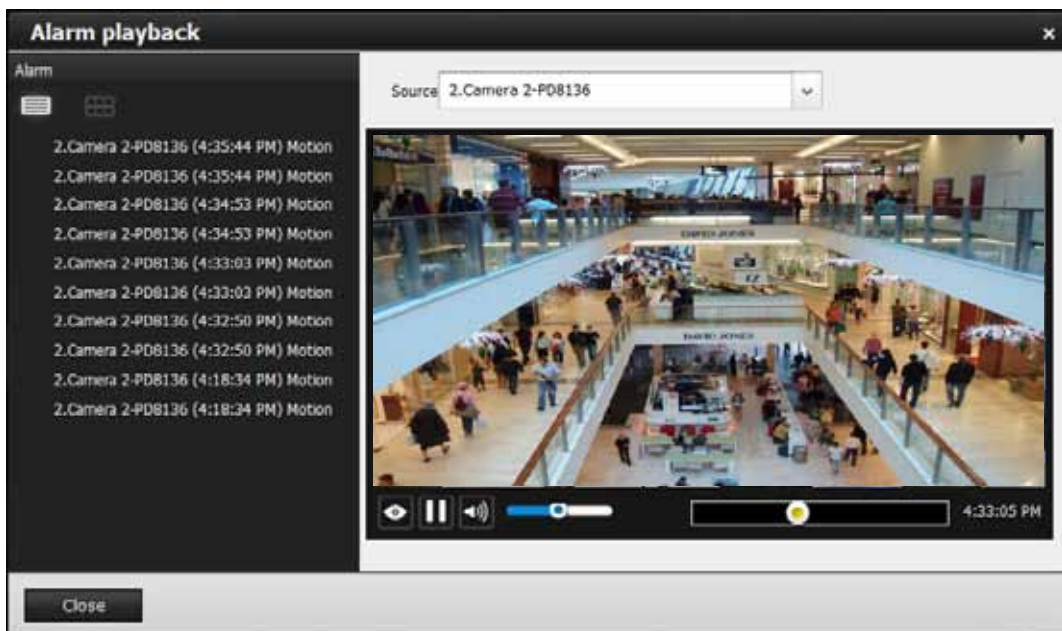

The alarm playback window will begin playback of footage from **10 seconds** before the alarm. The playback of an alarm-triggered recording will normally last for **one minute**. If, however, you configured a shorter pre- and post-alarm recording time, your alarm recording may be slightly shorter. The defaults for **pre-** and **post-alarm** buffer time are 5 seconds and 20 seconds.



Click and read a text-only alarm will turn off the alarm icon . The alarm icons  indicate unread alarms. The number of unread alarms will be listed on the title bar.





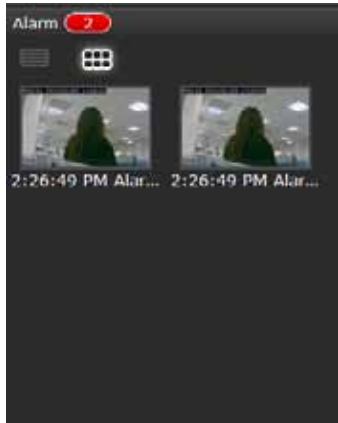

You can click on the icon mode  button to have a glimpse of alarms indicated by their snapshots taken by the time of the occurrences. If the alarm is triggered by NVR DI pins, no snapshots will be available.

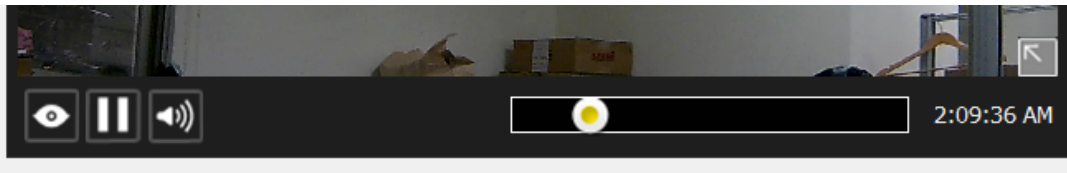
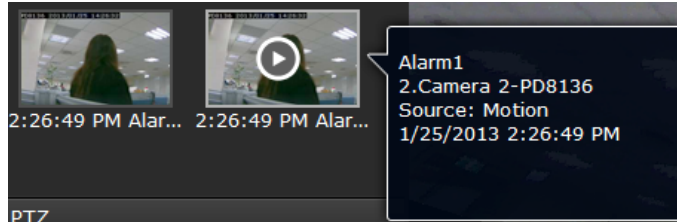

Move your cursor over an alarm with a recorded footage. The Play button will become available.

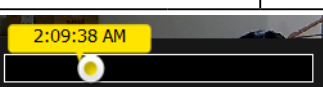

The following buttons are available in the alarm playback window.

| Buttons | Description |
|---|---|
|  | View live video: displays the live view streaming instead of the alarm recording. |
|  | Resumes the alarm playback. |
|  | Begins the alarm playback. |
|  | Pauses the current playback. |
|  | Mute or unmute the audio with the current playback. Drag the controller to change the audio volume level. |
|  | Use the playback slider to quickly change the playback position. |

Incoming Alarms

New alarms will be indicated by the messages in bold letters, the alarm bell icons, and the increasing number of unread messages **3** on the title bar.

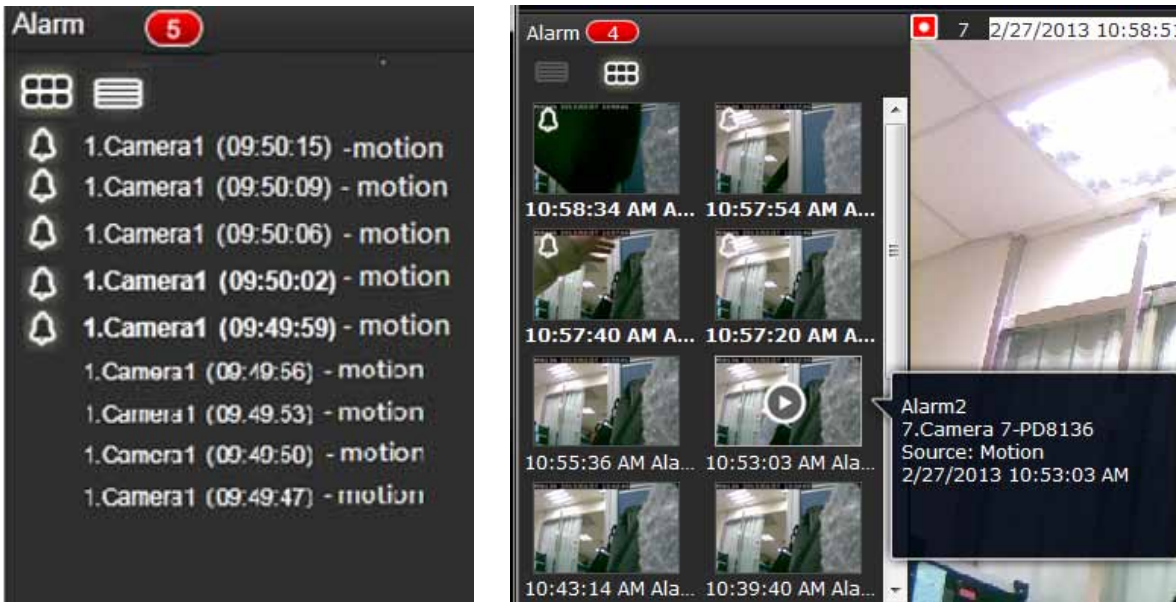

A text-based history of past Alarms is accessed through the **Alarm - History** page in the **Settings** window. See page 110 for information.

2-3. Graphical Layout and Screen Elements - Playback

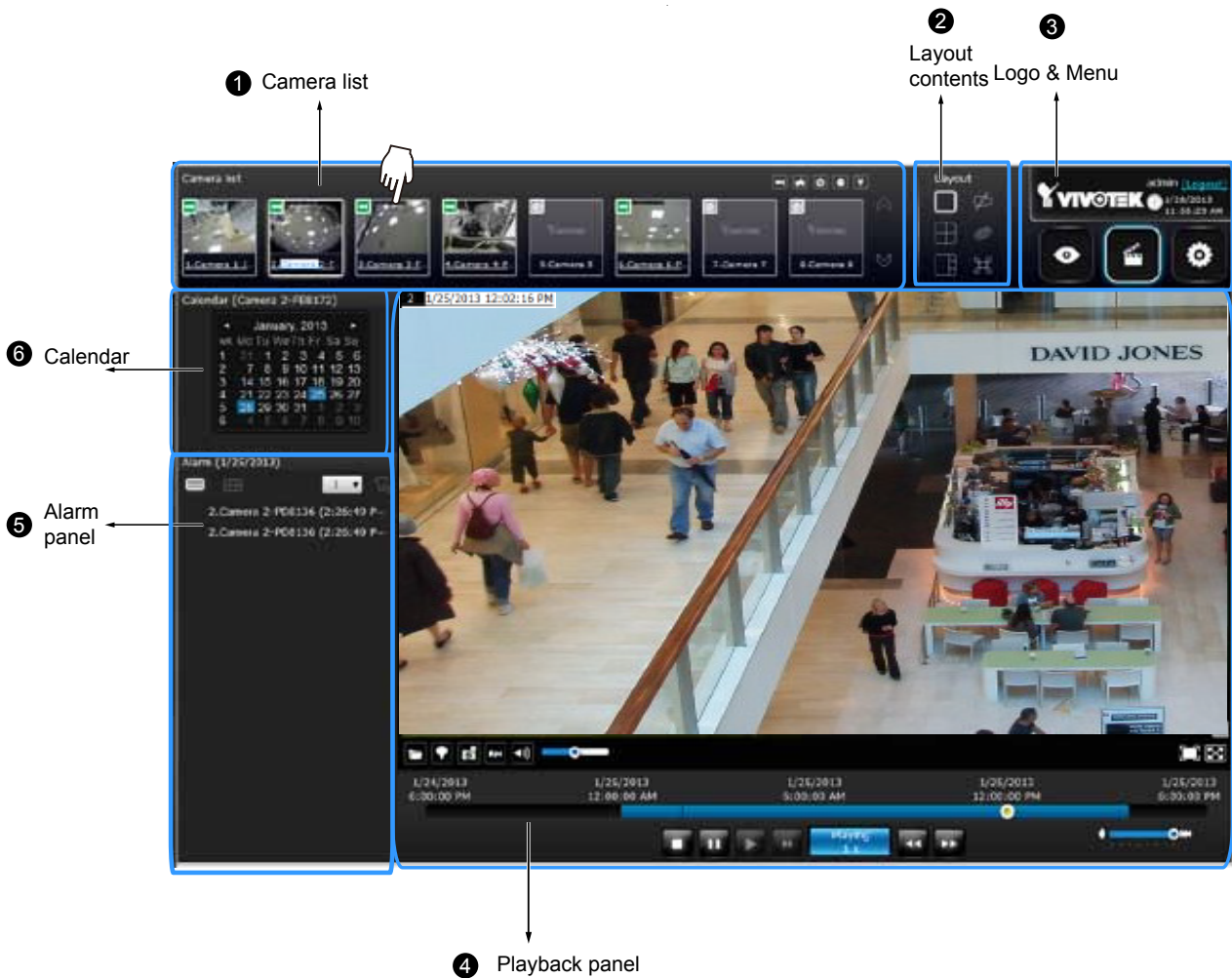

The screen elements of the **Playback** window are described as follows:

| Item | Name | Description |
|------|-----------------|--|
| 1 | Camera List | Provides a glimpse of all cameras that have recorded data. Basic information is also provided along with a screenshot. |
| 2 | Layout contents | Provides functions to extend, rotate, redo the layout, and for synchronous playback. |
| 3 | Logo & Menu | Provides access to the Playback and System Settings utilities, as well as system time and logout function. |
| 4 | Playback panel | Displays the playback functions. Snapshot, bookmark, and export functions are also available on individual view cells. |
| 5 | Alarm panel | Reports alarms transmitted via cameras' DI connections or those by the Motion Detection, etc. |
| 6 | Calendar | Shows when the recording took place, and thus enables users to quickly locate a specific part of recording in history. |

2-3-1. Camera List Panel

The camera list displays the 16 recruited cameras by the sequential numbering order you configured in the System **Settings** window. The elements in the Camera list on a **Playback** window are identical to those on a **Liveview** window. Please refer to page 30 for details on the Camera list panel.

There are two key differences between the Camera List on Liveview and that on the Playback window:

1. Users **can not** click and drag a camera thumbnail to a playback view cell.
2. A double-click on a camera does not display video in a view cell. A double-click displays a **calendar** where days with recorded videos are shown.

To begin playback and search for past recordings,

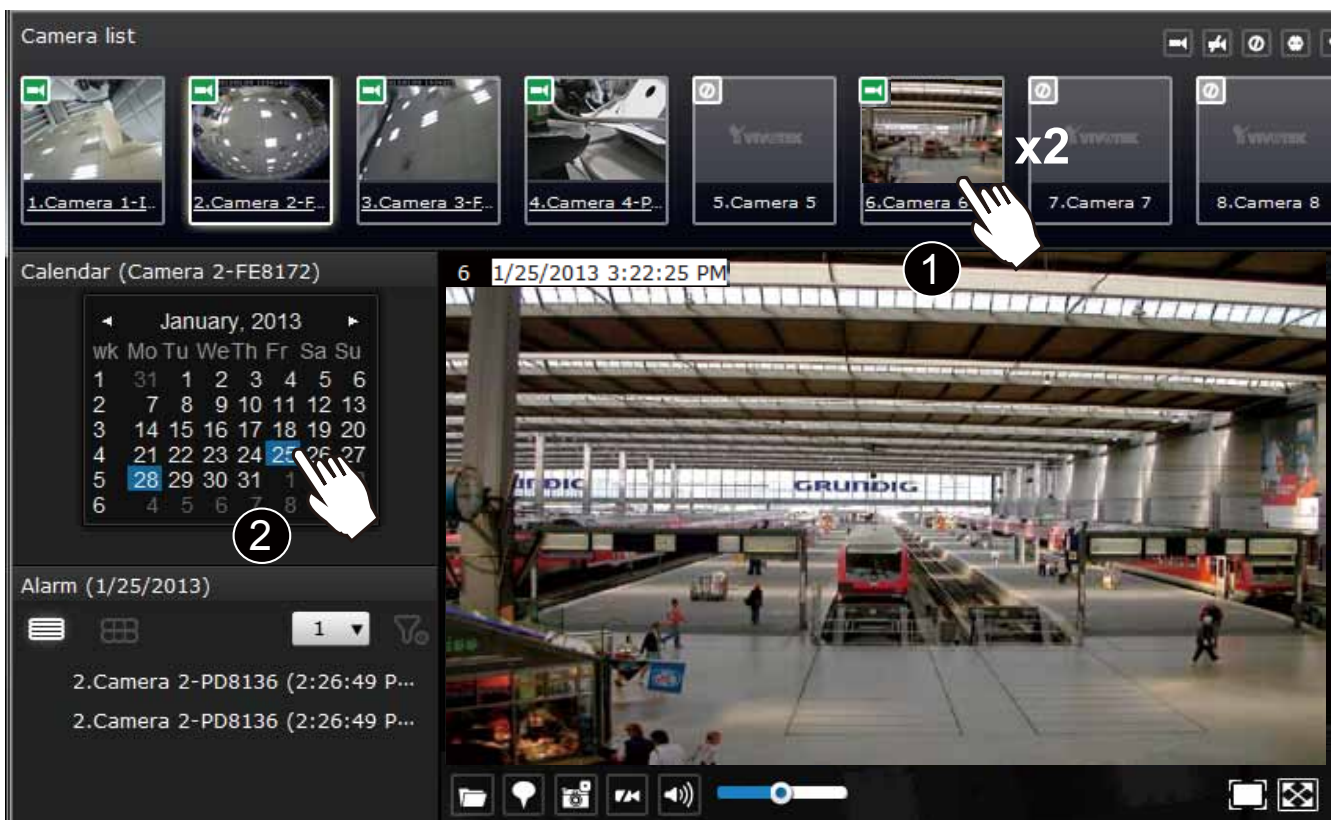

1. Double-click on a camera.
2. The **Calendar** panel will display the days video recording actually took place. And those days will be highlighted by a blue background (as the 25th and 28th in the screen below.)



2-3-2. Playback Layout

3 types of layouts are provided for the Playback window. They include: 1x1, 2x2, and 1+3.

In the playback window, users can simultaneously playback up to 4 recorded videos.

| | |
|---|--|
|  | Clears all view cells on the current layout |
|  | Starts or stops the Synchronous playback. |
|  | Full view: extends the view cells on the current layout to the full of the screen. |

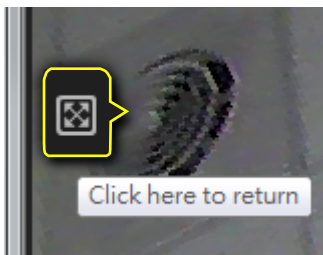

When your current layout is displayed in a full view, move your cursor to the left center of the screen to return to the default Liveview screen. The Return button will appear.

2-3-3. Logo & Menu













A logout button, system time panel , and 3 hot link buttons to access the **Liveview**, **Playback**, and **System Settings** utilities. This panel is identical to that on the Liveview window.

2-3-4. Playback View Cells

The view cells in Liveview and Playback windows are similar. Their differences are listed as follows:

1. 3 simple layout types are supported as previously discussed.
2. The information bar displays camera index and video time information only.
3. The Play and Pause buttons are not available on the Tool bar. One Export function is added on a Playback view cell.







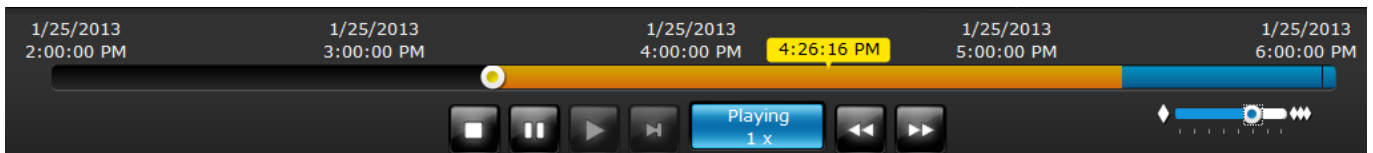
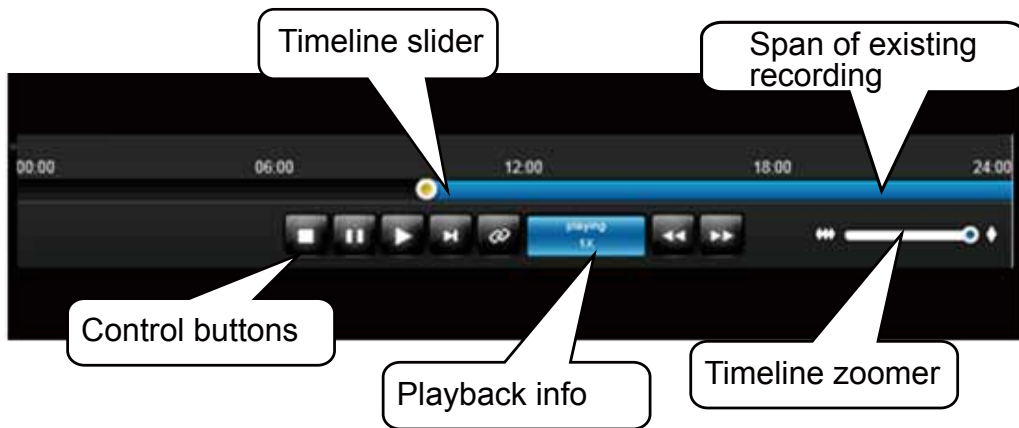



The functional buttons on an individual view cell are described as follows:



| Buttons | Description |
|---|--|
|  | Exports a section of the video into a 3GP or Windows exe file. The length of exported video is configurable to 1, 3, 5, or 10 minutes. |
|  | Adds a Bookmark (that saves a short description and a one-minute footage from the current feed) |
|  | Takes a snapshot. |
|  | Removes camera from the view cell. |
|  | Mutes (if there is audio input from the camera.) |
|  | Unmutes |
|  | Restores the view cell's original position on the liveview panel. |
|  | Maximizes the size of current view cell. |
|  | Activates the PiP function. |
|  | Disables digital zoom (PiP). |
|  | Volume controller |
|  | <p>Fisheye viewing modes - if the view cell contains video from a fisheye camera, the fisheye display mode selector will be available:</p> <p>1O: the original circular view. 1P: the panoramic view. 1R: the regional view.</p> <p>Please refer to the fisheye camera's User Manual for more information.</p> |

Playback control panel



The time slide bar enables quick skimming through the recording. Its functional buttons are described as follows:

| Buttons | Description |
|---|---|
|  | Pause |
|  | Play. This button is available after you manually paused a playback. |
|  | Stops the current playback. |
|  | Next frame. After you paused a playback, use this button to browse video frame by frame. |
|  | Speeds down by 1/2. The slowest speed is 1/8. |
|  | Speeds up. Increases the playback speed, to 2x, 4x, 8x, 16x, 32x, and then to a maximum of 64x. |
|  | Displays the current playback status, such as Playing, Pause, or Stop. |
|  | Restores the view cell's original position on the liveview panel. |
|  | Maximizes the size of current view cell. |
|  | Activates the PiP function. |
|  | Disables digital zoom (PiP). |

| | |
|---|---|
|  | <p>Timeline zoomer. Use the zoomer to zoom in for more precise skimming.</p> |
|  | <p>Timeline slider thumb. Click and drag this thumb button to move along and reach a specific point in time. A click on the time line will also work.</p> |

The time line shows the length of existing recording taken on a specific time span. You can use the timeline zoomer to scale down the span of time. For example, if the time span is reduced to 1 hour, then each section on the time line represents 15 minutes of recording. The total time span of a timeline starts from the minimal of 4 minutes, 20 minutes, 40 minutes, 1 hour, and up to a maximum of 24 hours.

In Synchronous play mode, a change to the zoomer will be reflected by all synchronously playing view cells.

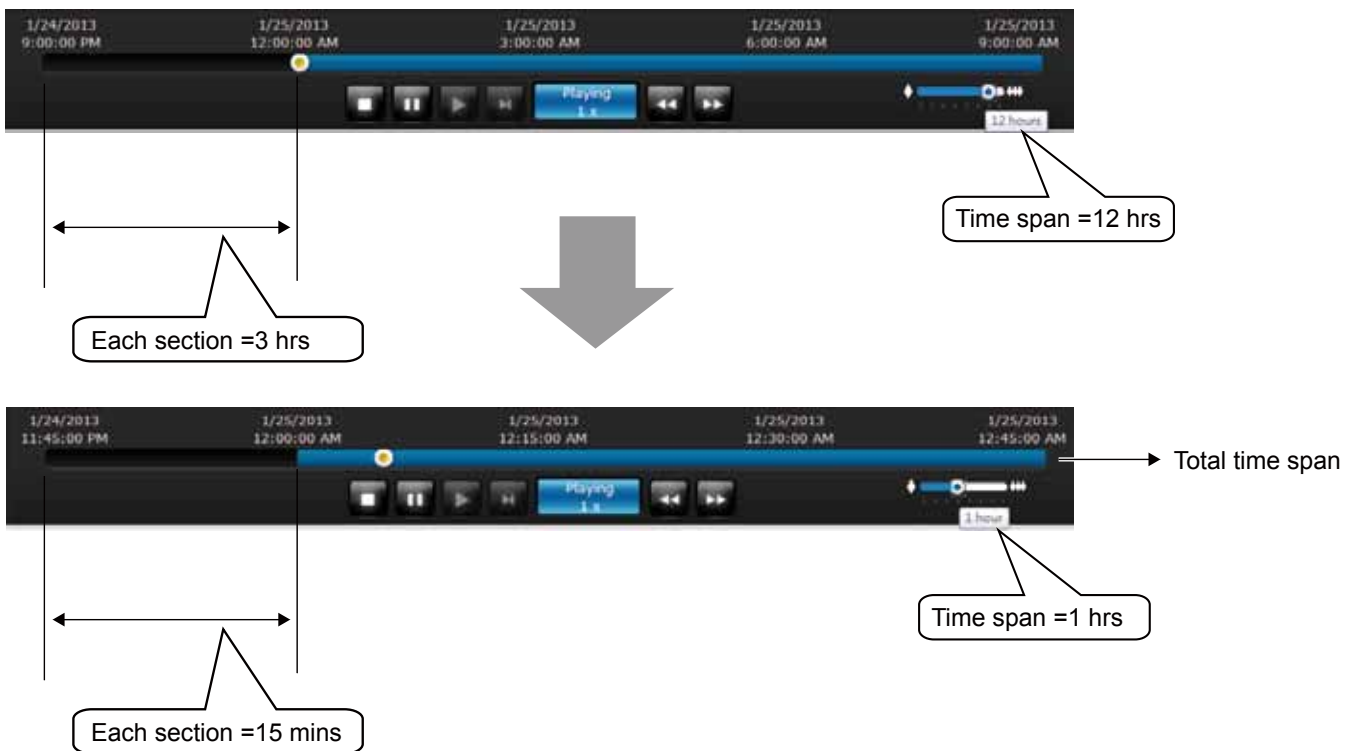

If recordings take place by an event-triggered recording, the intervals between recordings can be down to 1 minute, and the individual recordings will not be easily discernible. In this situation, you can mouse over the timeline to pinpoint individual recording instances.

2-3-5. Alarm Panel

The alarm panel displays the alarms or bookmarks recorded by the day of recording. Two additional buttons are available: **Page selector** and **Alarm filter**.

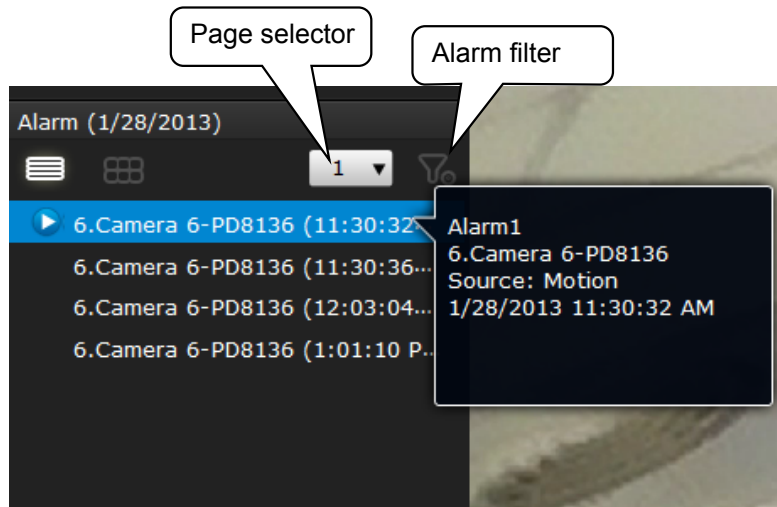

See page 99 for how to configure alarms.

- A playback button will be available with an alarm-triggered recording. The alarm panel in the Playback window also supports the List mode and Icon mode that are similar to that in the Liveview window.
- There can be numerous alarms occurring in a day. Use the page selector to display different pages of alarm entries. Up to 200 entries can appear on one page. Note that the new alarms that occurred seconds or minutes ago may not be instantaneously listed on the page.

If bookmarks are listed in the Alarm list, a bookmark entry will look like this:

[Camera index. camera name \(time\) - bookmark](#)

In the icon mode, a bookmark message will look like this:

[Camera index. camera name bookmark, time of marking](#)

Alarm filter:

Use the Alarm filter to find out specific alarms. Use the check circles below to narrow down your search criteria by Alarm name, alarm type by Motion detection, DI, DO, or those manually marked down as Bookmarks.

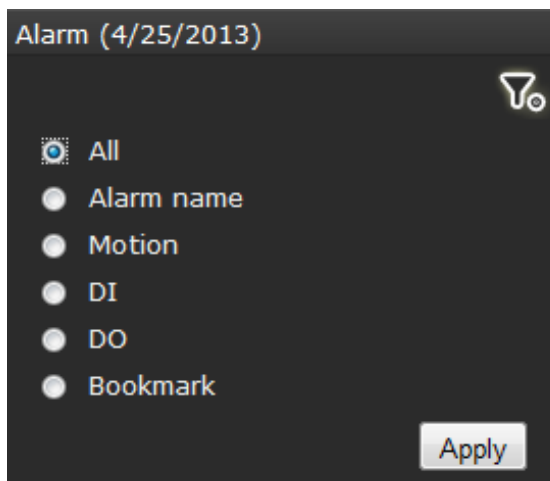

The alarm name is defined by users in the **Settings** > **Alarm** page.

2-3-6. Calendar Panel

Double-click on any of the existing cameras to display the Calendar panel. Days with recorded videos will be highlighted in blue regardless of the length of existing recordings that occurred in that day. You may then click on a day to begin viewing the past recordings.

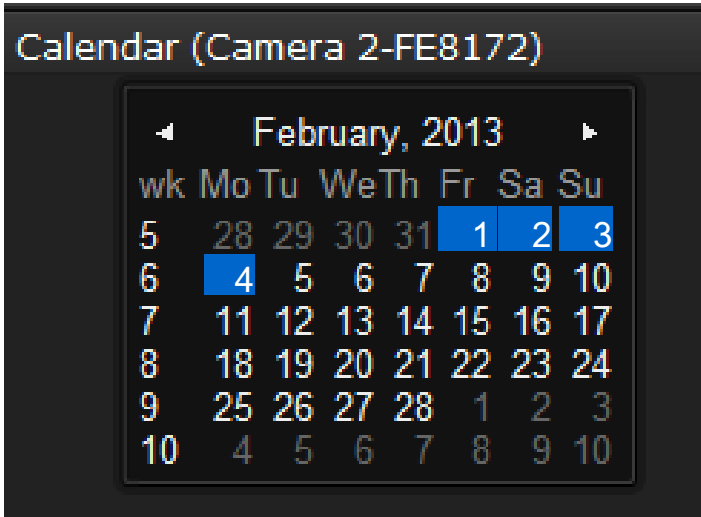

You may use the arrow button to view the records in other months. If there are no recordings in the current month, the recordings taken in the days of the following month will be shown instead.





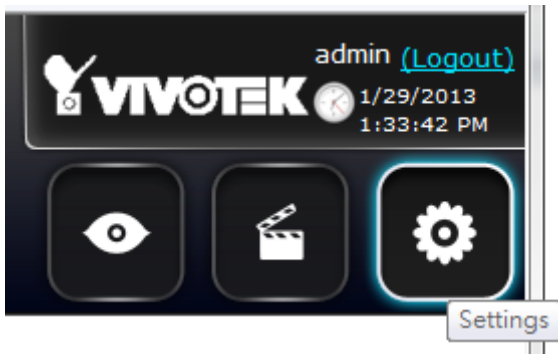

Chapter Three System Settings

The Settings window is accessed by clicking on the Settings button on the Logo panel.









You will enter the Overview of the Settings window. All the configuration menus are placed under 7 major categories: **System, Network, Camera, Storage, Security, Alarm, and Logs**. Click on any of the menu shortcuts to begin configuration.

Settings overview

-  System
-  Network
-  Camera
-  Storage
-  Security
-  Alarm
-  Logs

Overview

- | | |
|---|--|
| <p> System</p> <ul style="list-style-type: none"> General Upgrade Backup Maintenance DI and DO | <p> Storage</p> <ul style="list-style-type: none"> Volume Disk |
| <p> Network</p> <ul style="list-style-type: none"> General DDNS Service Utility | <p> Security</p> <ul style="list-style-type: none"> User account Access list |
| <p> Camera</p> <ul style="list-style-type: none"> General Video Schedule | <p> Alarm</p> <ul style="list-style-type: none"> General Source Action Schedule History |
| | <p> Logs</p> <ul style="list-style-type: none"> System Recording User Error |

Pnotify - During the configuration process, configuration errors or information will be indicated by a small pnotify message boxes on the lower right of the screen.



3-1. System

3-1-1. System - General

The system general information window allows you to change the system host name, time zone, system date and time, and set up a scheduled reboot of the system.

Note that if **NTP** time server configuration is preferred, you should configure all of your cameras to listen to the same time server as those shown in the pull-down menu. You need to configure camera settings over a web console, and set up the same configuration in the **System > General settings > System time** page. The precondition is that the system must have access to the Internet.

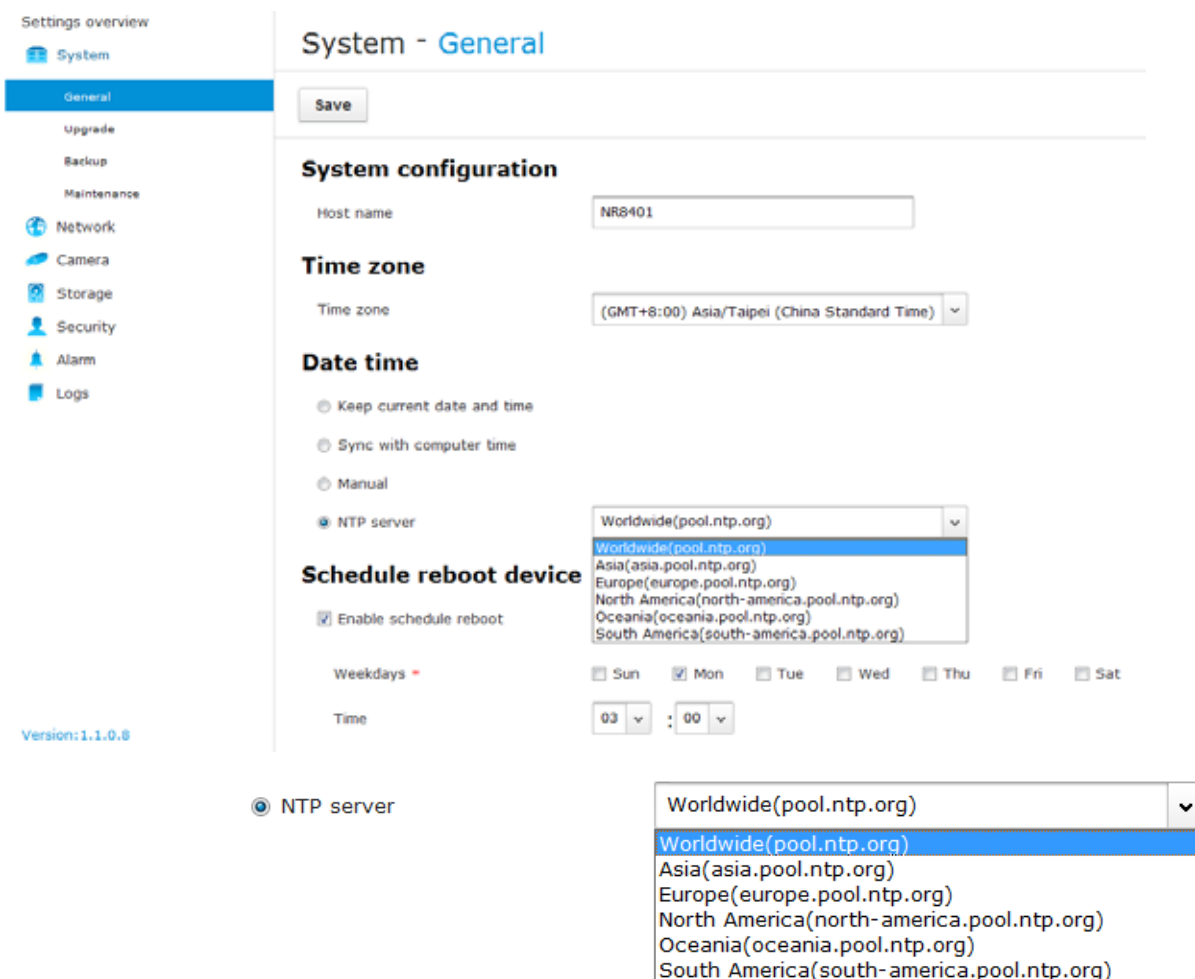

The Schedule reboot device allows the system to clean up dirty cache by a scheduled reboot. You can configure a reboot by a specific time within a week. Note that during the reboot the video recording will be temporarily interrupted.

Scheduled reboot is an recurring event. Select the day within a week and a time for the reboot using the checkboxes and drop-down menus.

3-1-2. System - Upgrade

If the need arises for updating system firmware, acquire the update from VIVOTEK's technical support or download site. Locate the firmware binaries, and click Upgrade. The upgrade should take several minutes to complete. Note that during the upgrade, the recording task will be interrupted.

System - Upgrade

Upgrade

Warning, this operation will cause the system to restart. The recording function will be temporarily interrupted.

Firmware file *

Browse...

3-1-3. System - Backup

On this window, you can perform 3 maintenance tasks:

1. **Backup** - You can backup your system configuration using the Backup function. Click Backup, a message window will prompt. Click Save to preserve your system configurations.

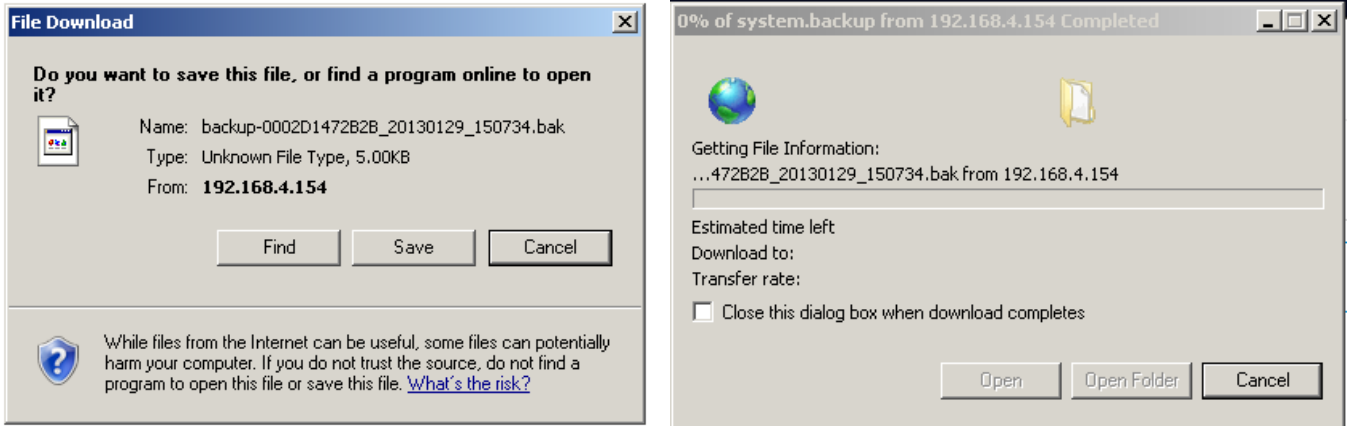

Select a location for your backup file, then click Save to complete the process.

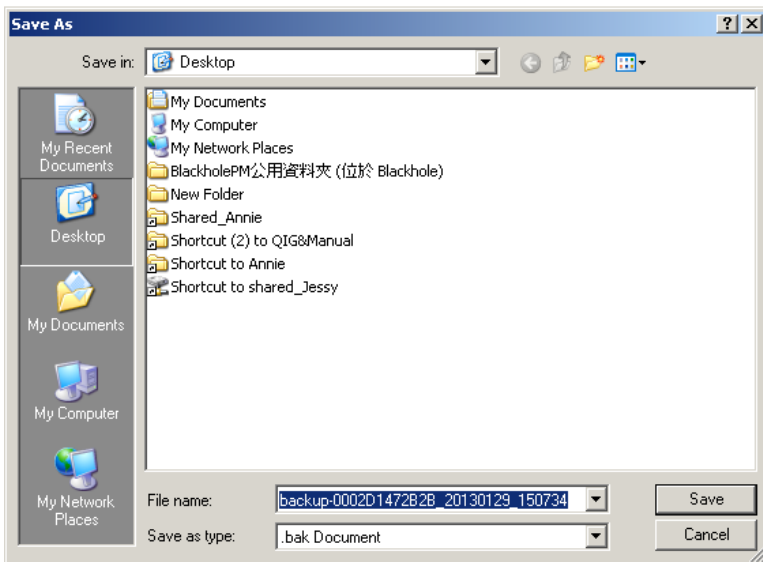

Note that the backup action does not involve the following:

1. Recorded videos and database,
2. Alarm records, bookmarks, and bookmarked footages.

2. **Restore** - If you have a previously-saved profile, you can restore your previous configuration. Click the Restore button.

A file location window will prompt. Location the backup file, and click Open. The Restore process will take several minutes to complete, and system operation will be interrupted during the process.

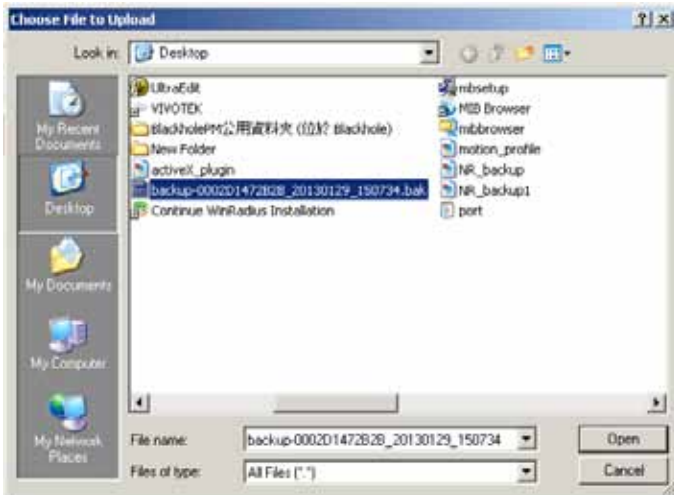

3. **Restore Default** - There are two kinds of defaults for the NVR systems: System defaults and factory defaults.

The **system defaults** can be restored using the pushbutton on the system front panel. This applies when users forget about its IP address or login password, while most other operation details will remain unchanged.

The **factory defaults** (operated on this window) restores to its primitive state before shipping, and hence users' configurations (such as host name, IP address, and layout settings) will be erased.

Click Restore to restore your system defaults. A warning message will appear. Click OK to proceed. The Restore process will take several minutes to complete, and system operation will be interrupted during the process.

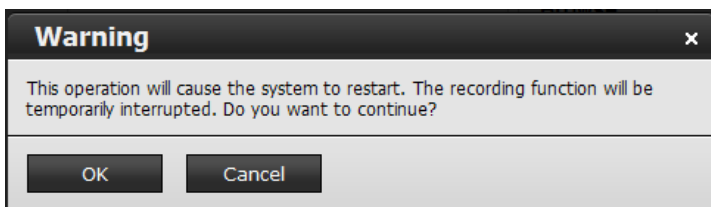

A successful operation will produce the following message.

 Restore completed

When Restoring the previous backup, the following should be noticed in terms of storage configurations:

1. If storage configuration has not been changed, restoring configuration will not affect the current storage configuration.
2. If changes have been made to storage configuration, the backup-restore action will not displace the current storage configuration.
3. If users removed the current storage configuration, no storage volumes will be restored after a backup-restore procedure. Users then must create new storage volumes to proceed with recording tasks.
4. If users apply previous backup to a new NVR machine, system will detect the presence of different hard disks, and no storage configuration from the backup file will apply.
5. If users move all hard disks and backup file from an NVR to another, storage configurations will be stored on the new machine.

3-1-4. System - Maintenance

This window displays basic information of various aspects, including CPU and memory usage, LAN port operation and its bonding, disk drive temperatures, and UPS status.



The **Reboot** button is used to restart the NVR system.

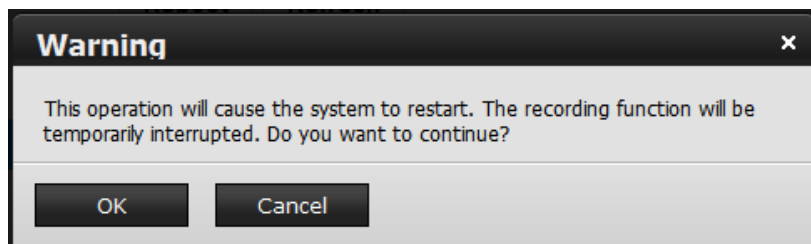

The Reboot process will take about 2 minutes to complete.



The **Refresh** button polls the system for the latest system information as previously described.

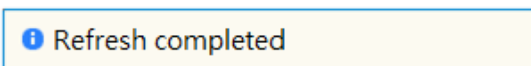

Pressing the Shutdown button will power off the NVR system. System will flush its cached contents, and stop the recording and streaming tasks.

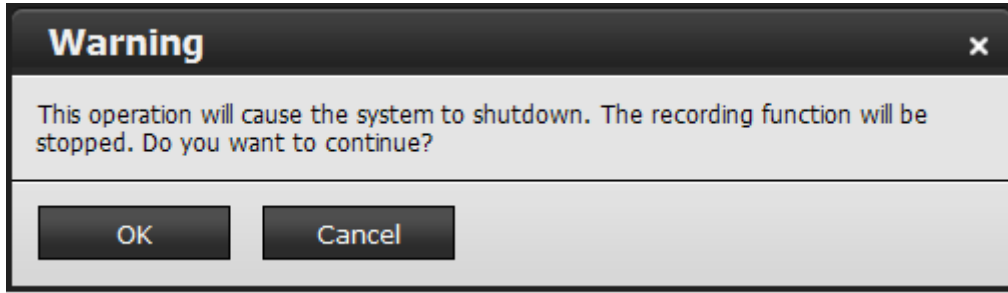

UPS support

Once an UPS is connected via the USB interface, the NVR system supports the cooperating protection against power outage. The UPS status [model name, status (Online or On battery), battery charge level] is listed in the Maintenance page as shown below.

The NVR supports APC's Back-UPS and Back-UPS Pro series models.

Reactions on power outage:

When the UPS battery charge is lower than 10%, or can only sustain system operation for 3 minutes, the NVR system will automatically shut down. When the power source is restored, the NVR system will automatically power up.

The screenshot shows the 'System - Maintenance' page in a web interface. On the left is a sidebar with navigation options: Settings overview, System, General, Upgrade, Backup, Maintenance (highlighted), Network, Camera, Storage, Security, Alarm, and Logs. The main content area has 'System - Maintenance' at the top, followed by 'Reboot' and 'Refresh' buttons. Below these are various system metrics in a table format. At the bottom of this table, three rows are highlighted with a red box: 'UPS model' (Back-UPS), 'UPS status' (On line), and 'UPS battery' (75%).

| System - Maintenance | |
|--|-------------------|
| <input type="button" value="Reboot"/> <input type="button" value="Refresh"/> | |
| LAN1 packets received | --- |
| LAN1 packets sent | 5018826 |
| LAN1 error packets | --- |
| LAN2 MAC address | 00:02:D1:47:2B:2B |
| LAN2 packets recieved | 0 |
| LAN2 packets sent | 0 |
| LAN2 error packets | --- |
| Load balance/failover error MAC address | 00:02:D1:47:2B:2B |
| Load balance/failover packets recieved | 11685973 |
| Load balance/failover packets ssent | 5018811 |
| Load balance/failover error packets | --- |
| Disk1 temperature | 46°C/114°F |
| Disk2 temperature | 45°C/113°F |
| Disk3 temperature | 45°C/113°F |
| Disk4 temperature | --- |
| UPS model | Back-UPS |
| UPS status | On line |
| UPS battery | 75% |

Version: 1.1.0.5

3-1-5. System - DI and DO

This window displays the digital input and output settings for the connections via the system's terminal block. You can connect the sensor devices (such as a PIR sensor) to the terminal block. The system will automatically detect the current connection as a high or low signal. You can then define the normal status for the input or output pins.

System - DI and DO

Normal status

| | | |
|-----------------|------|---|
| Digital input 1 | Low | ▼ |
| Digital input 2 | Low | ▼ |
| Digital input 3 | Low | ▼ |
| Digital input 4 | Low | ▼ |
| Digital output | Open | ▼ |

Current status

| | |
|-----------------|------|
| Digital input 1 | Low |
| Digital input 2 | Low |
| Digital input 3 | Low |
| Digital input 4 | Low |
| Digital output | Open |

3-2. Network

3-2-1. Network - General

Two major configuration options are available here: Bonding mode and Address settings.

1. Bonding mode:

Make sure both of your LAN ports are connected to network, and select one of the checkboxes below:

By default, the system network interfaces come in the Standalone mode.

Network - General

Save

Bonding mode

- Failover
- Load balance
- Standalone

Address settings

- Get IP address automatically
- Use fixed IP address

1-1. Failover - failover provides the capability to transfer network traffic through the surviving LAN port if any of the two LAN ports is disconnected.

1-2. Load balance - Based on 802.3ad, Load balance enables two LAN ports to share the load of network traffic. Non-layer 3 traffic, such as Multicast/broadcast requests will be transmitted via one of the LAN ports. To best utilize this feature, you should use a managed Gigabit Ethernet switch and have its 802.3ad link aggregation feature enabled on the corresponding ports.

1-3. Standalone - When selected, different IPs will be assigned for each LAN port. The NVR can be accessed via different subnets.

You may connect these ports to different subnets. For example, LAN1 to a router and have the access to the Internet; and LAN2 to a private subnet. In this case, however, you should appoint LAN1 as the default routing interface, so that Internet access is available for DDNS settings or remote access.

Network - General

Save

Bonding mode

- Failover
- Load balance
- Standalone

LAN1 settings

- Get IP address automatically
- Use fixed IP address

| | |
|-----------------|--|
| Address * | <input type="text" value="192.168.6.135"/> |
| Subnet mask * | <input type="text" value="255.255.255.0"/> |
| Default gateway | <input type="text" value="192.168.6.1"/> |
| Primary DNS | <input type="text" value="192.168.0.21"/> |
| Secondary DNS | <input type="text" value="192.168.0.22"/> |

LAN2 settings

- Get IP address automatically
- Use fixed IP address

Default routing interface settings

- LAN1
- LAN2

2. Address settings:

Get IP address automatically: Select this option to obtain an available dynamic IP address assigned by the DHCP server each time the system is connected to the LAN.

Use fixed IP address: Select this option to manually assign a static IP address to the Network Camera.

Enter the Static IP, Subnet mask, Default router, and Primary DNS provided by your ISP.

Subnet mask: This is used to determine if the destination is in the same subnet. The default value is "255.255.255.0".

Default gateway: This is the gateway used to forward frames to destinations in a different subnet. Invalid router setting will fail the transmission to destinations in different subnet.

Primary DNS: The primary domain name server that translates hostnames into IP addresses.

Secondary DNS: Secondary domain name server that backups the Primary DNS.

When finished with the network settings, click on the **Save** button.

3-2-2. Network - DDNS

VIVOTEK provides Safe100.net, as a free DDNS dynamic domain name service for users who need access from the internet or a domain name service for the NVR. VIVOTEK maintains a database of product MAC addresses for the Safe100.net service, and you can apply one domain name for each NVR system.

Network - DDNS

Save
Register...
Forget key

Enable dynamic DNS service

Host name *

Email *

Key *

Enable dynamic DNS service: Select this checkbox to enable the DDNS setting.

Make sure you have internet access. Click the **Register** button. The terms of service agreement window will prompt. Click **Accept** to proceed.



In the Register column, fill in the Host name (xxxx.safe100.net), Email, Key, and Confirm Key, and click **Register**. After a host name has been successfully created, a success message will be displayed in the DDNS Registration Result column.

NOTE:

If one LAN port is connected to the Internet, and the other LAN port is connected to another subnet and the default routing port is not set to the Internet port, the DDNS function will not be available.

Enter a Host name, Email address, and password twice, and then click **Register** to proceed.

The acceptable characters for email address are: [0-9][a-z][A-Z][!][#][\$][%]['][*][+][-]/[]=[]?[]^[]_[]`][{ }|]][~][.]. Two successive periods, [..], are not acceptable. The address filed can accommodate up to 256 characters.

Use only alphabetic and numeric characters for the password. The maximum number of characters is 64.

When completed, a confirm message will prompt. You will also receive a confirm Email. You can now access your NVR system using the xxxx.safe100.net domain name address. Note that access from the Internet should be routed to the private IP assigned to your NVR, using methodologies such as port forwarding, etc. Successful and invalid input will display the following messages.

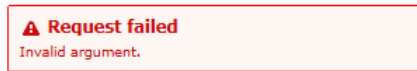

Forget key: Click this button if you have forgotten the key to Safe100.net account. Enter host name and Email address, and then click the Forget key button. Your account information will be sent to your Email address

Network - DDNS

3-2-3. Network - Service

By default, the NVR service and video streaming are accessed via HTTP port 80 and RTSP port 554. You can designate a different port number if the need arises. Usually it is not necessary to change these ports.

Network - Service

Save

HTTP port: 80

RTSP port: 554

Allow CMS and iViewer connection

Port: 3454

Password: *****

Instead of a web console, you can also access the NVR and the subordinate cameras using the **iViewer** and VIVOTEK's **VAST** software. The NVR can be managed as one of the sub-stations in a hierarchical device structure.

Note that the password here should be identical to that you use to log in to a VAST server. For iViewer, you log in using the same user name and password for the login to the NVR.

VAST LiveClient

Login local station

Address: 192.168.4.154

User Name: admin

Password: *****

Port: 3454

Proxy Settings

Login Cancel Hide <<

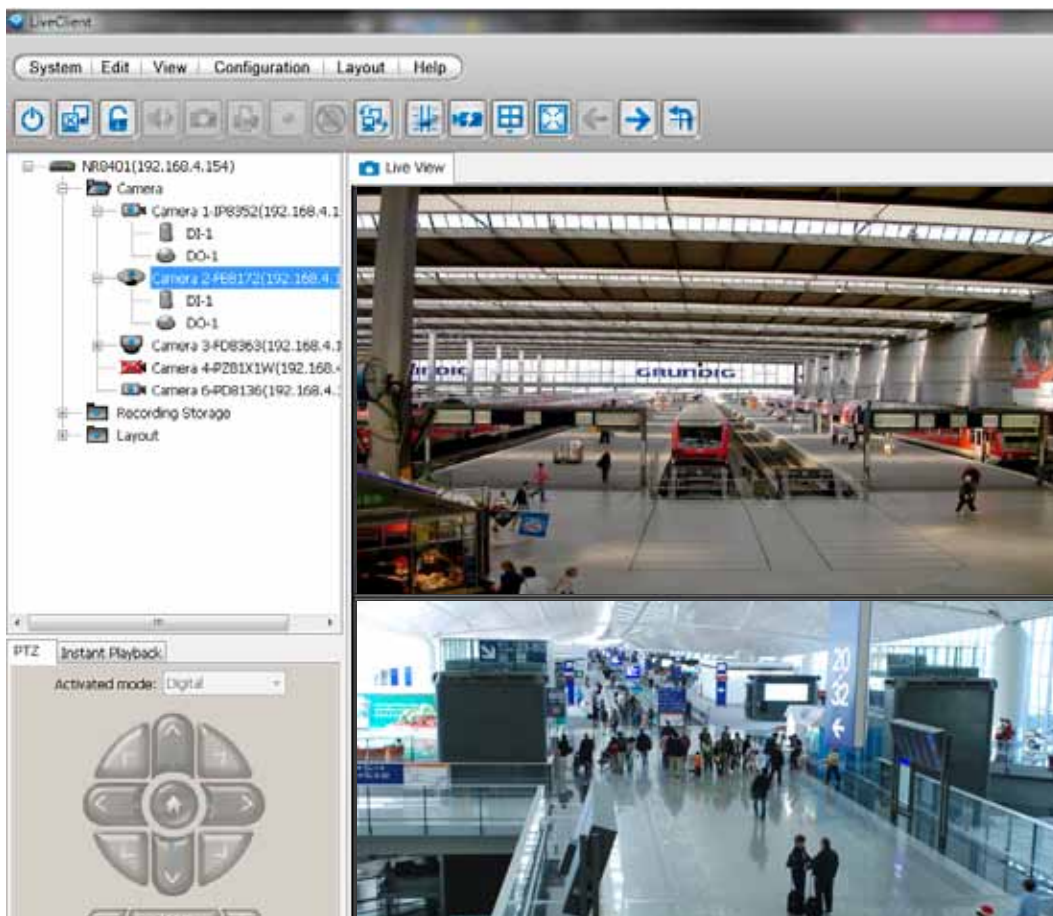

3-2-4. Network - Utility

Use the test utility to test the connectivity with a network device, such as a camera. Test results will be displayed by a message prompt.

Network - Utility

Test

Address to test

192.168.4.154

✓ **Test successfully**

Failure to reach a device displays the message below.

▲ **Test failed**
Request timeout.

3-3. Camera

3-3-1. Camera - General

The camera window provides management tools to recruit or disband cameras from your NVR configuration.

Camera - General

Save Delete Search...

| * # | Name | IP address | Port | MAC address | Model | Channel |
|-----|------------------|---------------|------|-------------------|--------|---------|
| 1 | Camera 1-IPB352 | 192.168.4.148 | 80 | 00:02:D1:11:7A:4A | IPB352 | 1 |
| 2 | Camera 2-FE8172 | 192.168.4.150 | 80 | 00:02:D1:19:60:E8 | FE8172 | 1 |
| 3 | Camera 3-FD8363 | 192.168.4.151 | 80 | 00:02:D1:1E:3D:50 | FD8363 | 1 |
| 4 | Camera 4-PZ81X1W | 192.168.4.152 | 80 | --- | --- | --- |
| 5 | Camera 5 | | 80 | --- | --- | --- |
| 6 | Camera 6-PD8136 | 192.168.4.147 | 80 | 00:AB:CD:AB:CD:EF | PD8136 | 1 |
| 7 | Camera 7 | | 80 | --- | --- | --- |
| 8 | Camera 8 | | 80 | --- | --- | --- |
| 9 | Camera 9 | | 80 | --- | --- | --- |
| 10 | Camera 10 | | 80 | --- | --- | --- |
| 11 | Camera 11 | | 80 | --- | --- | --- |
| 12 | Camera 12 | | 80 | --- | --- | --- |
| 13 | Camera 13 | | 80 | --- | --- | --- |
| 14 | Camera 14 | | 80 | --- | --- | --- |

Connection Recording

Name: Camera 1-IPB352

Address: 192.168.4.148 : 80

User name:

Password:



1. Search:

The **Search** button allows you to locate all VIVOTEK cameras within a local network. Use the check circles on top to display **all cameras** or **only cameras that have not been recruited**.

Search

List the cameras which are not inserted List all cameras

| +/- | # | MAC address | IP address | Channel | Model | Port |
|-----|---|-------------------|---------------|---------|--------|------|
| | | 00:02:D1:1A:A9:AD | 192.168.4.108 | 1 | FD8161 | 80 |
| | | 00:02:D1:1E:3D:38 | 192.168.4.157 | 1 | FD8163 | 80 |

OK Cancel

On a listed camera, mouse over to the left of the entry to display the  Add button. Click on the button. To deselect a camera, use the  Remove button.

| +/- | # | MAC address | IP address | Channel | Model | Port |
|---|---|-------------------|---------------|---------|--------|------|
|  | | 00:02:D1:1A:A9:AD | 192.168.4.108 | 1 | FD8161 | 80 |
| | | 00:02:D1:1E:3D:3B | 192.168.4.157 | 1 | FD8163 | 80 |

Select a camera index number from the pull-down menu. The first unused number will be listed. You may also select a different number or a number already appointed to another camera. However, doing so will replace the existing camera.

| +/- | # | MAC address | IP address | Channel | Model | Port |
|---|---|-------------------|---------------|---------|--------|------|
|  | 5 | 00:02:D1:1E:3D:3B | 192.168.4.157 | 1 | FD8163 | 80 |
| | | 00:AB:CD:AB:CD:EF | 192.168.4.147 | 1 | PD8136 | 80 |

Repeat this process to select more cameras in your deployment, and then click the **OK** button.

 **IMPORTANT:**

If you select an index number already appointed to an existing camera for a new camera, the recorded data taken from the existing camera will still be intact. However, the recorded data is accessed through the same index number but using the name of the new camera.

Search ×

List the cameras which are not inserted List all cameras

| +/- | # | MAC address | IP address | Channel | Model | Port |
|---|----|-------------------|---------------|---------|--------|------|
|  | 12 | 00:02:D1:1A:A9:AD | 192.168.4.108 | 1 | FD8161 | 80 |
| | 1 | DF:E9:9A | 192.168.4.15 | 1 | FD8161 | 80 |
| | 2 | 192.168.4.137 | | | | |
| | 3 | 192.168.4.151 | 192.168.4.113 | 1 | FD8161 | 80 |
| | 4 | 192.168.4.152 | | | | |
| | 5 | 192.168.4.147 | | | | |
| | 6 | 192.168.4.137 | | | | |
| | 7 | 192.168.4.106 | | | | |
| | 8 | 192.168.4.104 | | | | |
| | 9 | 192.168.4.105 | | | | |
| | 10 | 192.168.4.109 | | | | |
| | 11 | 192.168.4.107 | | | | |
| | 12 | 192.168.4.108 | | | | |
| | 13 | | | | | |
| | 14 | | | | | |
| | 15 | | | | | |
| | 16 | | | | | |

Annotations:

- New camera:** Points to the entry with IP 192.168.4.15 and Model FD8161.
- Index no. taken by an existing camera:** Points to the entry with index 4 and IP 192.168.4.152.

Buttons: OK, Cancel

The legends used in the camera list are described below:

| * | # | Name | IP address | Port | MAC address | Model | Channel |
|---|---|---------|------------------------------|------|-------------------|--------|---------|
| * | 1 | Camera1 | 172.16.6.162 | 80 | 00:02:D1:12:04:09 | IP8132 | 1 |
| | 2 | Camera2 | 172.16.6.164 | 80 | 00:02:D1:12:04:0A | IP8132 | 1 |
| | 3 | Camera3 | 172.16.6.185 | 80 | 00:02:D1:12:C7:3D | FE8171 | 1 |
| | 4 | Camera4 | | 80 | | --- | 1 |

(*) asterisk: An asterisk symbol indicates that a camera's settings have been modified.

(#) numbered: Camera index.

Name: Camera name.

IP address: A valid camera configuration enables the IP address as a hyper link. You can click on the hyper link to open an IE web console with the camera.

MAC address: A unique MAC address as that printed on the camera's label.

Model: Camera model name.

Channel: This indicates the stream number. If connected via a video server, the channel number indicates the channel through which an analogue camera is connected.

A recent snapshot from the camera will also appear at the bottom of the camera list window.

Left-click to select a camera, and edit the **Connection** and **Recording** configuration below:

- 1. Connection** - You can rename the camera, and if your camera comes with password protection, enter its **User name** and **Password** here. Otherwise, you will not be able to manage or access the camera.

| * # | Name | IP address | Port | MAC address | Model | Channel |
|-----|------------------|-------------------------------|------|-------------------|--------|---------|
| 3 | Camera 3-FD8363 | 192.168.4.151 | 80 | 00:02:D1:1E:3D:50 | FD8363 | 1 |
| 4 | Camera 4-PZ81X1W | 192.168.4.152 | 80 | --- | --- | --- |
| 5 | Camera 5 | | 80 | --- | --- | --- |
| * 6 | Camera 6-FD8163 | 192.168.4.157 | 80 | 00:02:D1:1E:3D:3B | FD8163 | 1 |
| 7 | Camera 7 | | 80 | --- | --- | --- |
| 8 | Camera 8 | | 80 | --- | --- | --- |
| 9 | Camera 9 | | 80 | --- | --- | --- |
| 10 | Camera 10 | | 80 | --- | --- | --- |
| 11 | Camera 11 | | 80 | --- | --- | --- |
| 12 | Camera 12 | | 80 | --- | --- | --- |
| 13 | Camera 13 | | 80 | --- | --- | --- |
| 14 | Camera 14 | | 80 | --- | --- | --- |
| 15 | Camera 15 | | 80 | --- | --- | --- |
| 16 | Camera 16 | | 80 | --- | --- | --- |

Connection
Recording

Name

Address :

User name

Password

If preferred, the acceptable characters for a new camera name can be: [0-9][a-z][A-Z][_][-][].
 The max. number of alphabetic and numeric characters is 64.

For a user name, the acceptable characters for a camera name can be: [0-9][a-z][A-Z][_][^][-][.][@][~][!][\$][%]. The max. number of characters is 64.

2. Recording:

2-1. **Keep all recordings for maximum * days** - determine the life span of recordings in your system. Usually old recordings will be erased when the storage volumes become full. When a storage volume is 90% full, the recorded videos taken on the oldest day (from every camera) will be erased. Deletion of old files will stop when the used space falls under 85% again.

When recycling takes place, the system buzzer will be triggered, and the recording task can be halted temporarily until more storage space is regained.

2-2. **Pre-alarm buffer time (seconds)** - if the alarm-triggered recording is preferred, set up a pre-alarm buffer for the system to record video before the occurrence of an alarm. The configurable options are 3, 5, 10, 15, and 20 seconds. A 20MB memory space is reserved for each camera, and therefore the pre-alarm buffer time can be shorter if the camera video is recorded using a higher resolution.

2-3. **Post-alarm buffer time (seconds)** - if the alarm-triggered recording is preferred, set up a length of time for the system to record video after the occurrence of an alarm. The configurable options are: 10, 20, 30, 40, and 60 seconds.

2-4. **Enable audio recording** - Selected by default. Audio input is also recorded along with the video. However, audio can be muted by default on some cameras. For example, a speed dome camera requires the connection to an external microphone, and the audio function is manually turned on through a management session with the camera.

2-5. **Enable manual recording** - If this checkbox is deselected, you will not be able to enable or disable manual recording from the Liveview view cells.

3. Delete:

To remove a camera from your list, left-click to select a camera on the list, and then click the Delete button.

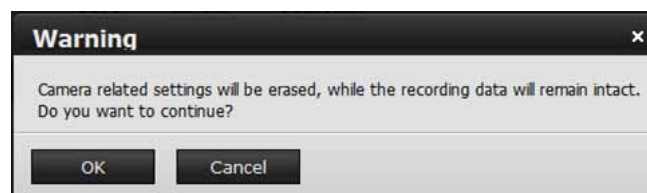

Note that once a camera is removed, all alarm settings related to the camera, such as DO and preset location settings, will be erased.

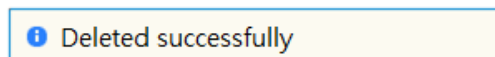

4. Save:

Click the **Save** button to preserve your configuration whenever changes are made to the configuration or when you are leaving this page.

Camera - General

Save
Delete
Search...

| * | # | Name | IP address | Port | MAC address | Model | Channel |
|---|---|------------------|---------------------------------|------|-------------------|---------|---------|
| | 1 | Camera 1-IP8352 | 192.168.4.148 ↗ | 80 | 00:02:D1:11:7A:4A | IP8352 | 1 |
| | 2 | Camera 2-FE8172 | 192.168.4.137 ↗ | 80 | 00:02:D1:19:60:E8 | FE8172 | 1 |
| | 3 | Camera 3-FD8363 | 192.168.4.151 ↗ | 80 | 00:02:D1:1E:3D:50 | FD8363 | 1 |
| | 4 | Camera 4-PZ81X1W | 192.168.4.152 ↗ | 80 | 00:02:D1:11:58:93 | PZ81X1W | 1 |
| | 5 | Camera 5 | | 80 | --- | --- | --- |

IMPORTANT:

Leaving the Camera - General page without saving your configuration, you will lose your configuration changes.

3-3-2. Camera - Video

The Video page determines the Liveview and recording streams of individual cameras in terms of compression format, video resolutions, frame rate, and the constant bit rate settings.

The constant bit rate setting is especially important in that the sum of bandwidth consumed for all recording streams must not exceed the **96Mbps** threshold. The constant bit rate is like an upper threshold placed on each video stream. The size of IP packets delivered from the network camera will be maintained within the bit rate limitation.

If you configured a RAID5 volume as recording storage, the bandwidth threshold will be **48Mbps**.

Camera - Video

| * | # | Name | IP address | Port | MAC address | Model | Channel |
|---|---|------------------|-------------------------------|------|-------------------|---------|---------|
| 1 | | Camera 1-IP8352 | 192.168.4.148 | 80 | 00:02:D1:11:7A:4A | IP8352 | 1 |
| 2 | | Camera 2-FE8172 | 192.168.4.137 | 80 | 00:02:D1:19:60:E8 | FE8172 | 1 |
| 3 | | Camera 3-FD8363 | 192.168.4.151 | 80 | 00:02:D1:1E:3D:50 | FD8363 | 1 |
| 4 | | Camera 4-PZ81X1W | 192.168.4.152 | 80 | 00:02:D1:11:58:93 | PZ81X1W | 1 |
| 5 | | Camera 5 | | 80 | --- | --- | --- |
| 6 | | Camera 6-FD8163 | 192.168.4.157 | 80 | --- | --- | --- |
| 7 | | Camera 7 | | 80 | --- | --- | --- |
| 8 | | Camera 8 | | 80 | --- | --- | --- |
| 9 | | Camera 9 | | 80 | --- | --- | --- |

| | Recording | Liveview |
|-------------------|--|--------------------------------------|
| Video compression | <input type="text" value="H.264"/> | <input type="text" value="H.264"/> |
| Video resolution | <input type="text" value="1280x1024"/> | <input type="text" value="960x768"/> |
| Frame rate | <input type="text" value="15"/> | <input type="text" value="15"/> |
| Constant bit rate | <input type="text" value="6 M"/> | <input type="text" value="6 M"/> |

1. **Video compression:** The supported formats are: MPEG-4, H.264, and SVC. **The MJPEG format is not supported.** If you change the bit rate and resolution settings of a camera, the configuration applies to the camera firmware settings on its individual video stream. If a camera becomes disconnected, your configuration change will not take effect until the camera comes online again.
2. **Video resolution:** The applicable video resolutions come available in a pull-down menu. For different cameras, the applicable resolutions can vary.
3. **Frame rate:** The applicable frame rate also varies from camera to camera. The list of applicable frame rates is polled from individual cameras.
4. **Constant bit rate:** This places an upper threshold to limit the bandwidths consumed for live viewing and recording streams. If "---" (not available) is shown, your camera stream might have been configured using a "fixed quality" setting. You may need to open a web console with it to convert the camera stream to be using the constant bit rate setting.

3-3-3. Camera - Schedule

The camera recording schedule can be configured down to an hourly basis. The default settings for cameras is to record videos at all time.

To set up a schedule,

1. Select a camera from the list using a single mouse click,
2. By default, all days and hours will be selected for continuous recording. If you want to disable recording for specific time during a week, or enable event-triggered recording during some time, use the **Event recording** and **No recording** buttons. Use them as a paint brush or eraser on the weekly time chart. Click or drag your mouse cursor across the time chart to change the recording schedule.

Change a non-recording hour to continuous recording by one click on the **Continuous recording** button and then click and/or drag on the time chart.

Camera - Schedule

Save

| # | Name | IP address | Port | MAC address | Model | Channel |
|----|------------------|---------------|------|-------------------|---------|---------|
| 1 | Camera 1-IP0352 | 192.168.4.149 | 80 | 00:02:D1:11:76:40 | IP0352 | 1 |
| 2 | Camera 2-FE8172 | 192.168.4.137 | 80 | 00:02:D1:19:60:E8 | FE8172 | 1 |
| 3 | Camera 3-FD8363 | 192.168.4.151 | 80 | 00:02:D1:1E:3D:50 | FD8363 | 1 |
| 4 | Camera 4-PZ81X1W | 192.168.4.152 | 80 | 00:02:D1:11:58:93 | PZ81X1W | 1 |
| 5 | Camera 5 | | 80 | --- | --- | --- |
| 6 | Camera 6-FD8163 | 192.168.4.152 | 80 | --- | --- | --- |
| 7 | Camera 7 | | 80 | --- | --- | --- |
| 8 | Camera 8 | | 80 | --- | --- | --- |
| 9 | Camera 9 | | 80 | --- | --- | --- |
| 10 | Camera 10 | | 80 | --- | --- | --- |

+ Continuous recording + Event recording - or - No recording

| | 0 | 1 | 2 | 3 | 4 | 5 | 6 | 7 | 8 | 9 | 10 | 11 | 12 | 13 | 14 | 15 | 16 | 17 | 18 | 19 | 20 | 21 | 22 | 23 |
|-----|--------|---|---|---|---|---|---|---|---|---|----|----|----|----|----|----|----|----|----|----|----|----|----|----|
| Mon | [Blue] | | | | | | | | | | | | | | | | | | | | | | | |
| Tue | [Blue] | | | | | | | | | | | | | | | | | | | | | | | |
| Wed | [Blue] | | | | | | | | | | | | | | | | | | | | | | | |
| Thu | [Blue] | | | | | | | | | | | | | | | | | | | | | | | |
| Fri | [Blue] | | | | | | | | | | | | | | | | | | | | | | | |
| Sat | [Blue] | | | | | | | | | | | | | | | | | | | | | | | |
| Sun | [Blue] | | | | | | | | | | | | | | | | | | | | | | | |

The color codes for the display on the time chart are shown below:

| | |
|----------------------|---------|
| Continuous recording | [Blue] |
| Event recording | [Red] |
| No recording | [White] |

The **Event recording** is triggered by digital inputs or motion detection. You can click on the setup button  to select or deselect the triggering options.

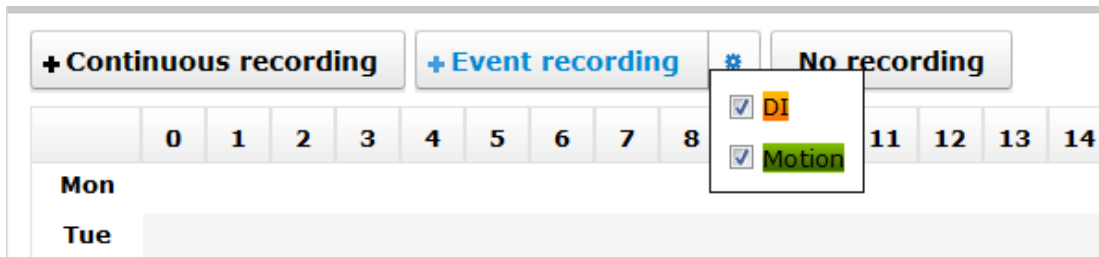

The interface shows three recording mode buttons: '+ Continuous recording', '+ Event recording' (highlighted in blue), and 'No recording'. Below these is a grid for configuring event recording options. A dropdown menu is open over the 'Event recording' button, showing two checked options: 'DI' (Digital Input) and 'Motion'.

| | 0 | 1 | 2 | 3 | 4 | 5 | 6 | 7 | 8 | 9 | 10 | 11 | 12 | 13 | 14 |
|-----|---|---|---|---|---|---|---|---|---|---|----|----|----|----|----|
| Mon | | | | | | | | | | | | | | | |
| Tue | | | | | | | | | | | | | | | |

3-4. Storage

3-4-1. Storage - Volume

With up to 4 disk drives, you have the following options for configuring storage volumes:

- 1. Single disk:** The single disk configuration provides no fault tolerance. The system stores video recordings to one or more single disk volumes in a consecutive order.

Single disks

Each single disk volume contains one disk drive.

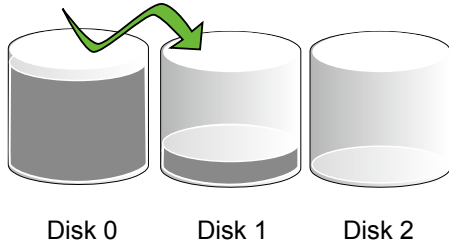

- 2. RAID0:** A RAID0 volume spreads data blocks of each file across multiple disk drives. The volume provides no redundancy. RAID0 provides high performance by simultaneously reading or writing to disk drives, but if a drive fails, all data within is lost. Select at least 2 disks to build a RAID0 volume.

RAID0

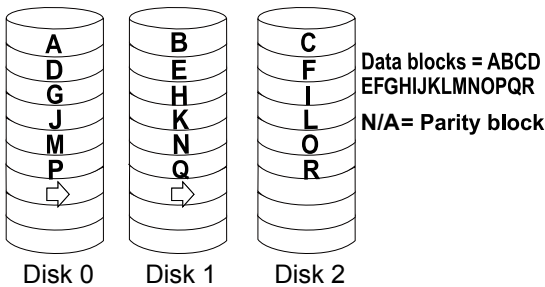

- 3. RAID1:** A RAID1 volume provides high fault tolerance by writing the same data blocks simultaneously to duplicate disks. Select at least 2 disks (or 4 disks) to build a RAID1 volume.

RAID1

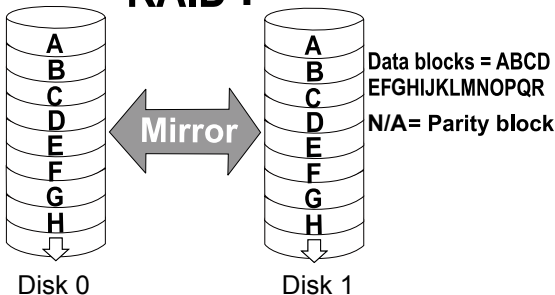

4. RAID5: A RAID5 volume provides a balance in performance and good fault tolerance. RAID5 stripes data and also generates error correction information (parity bits). One drive's capacity is needed to store the error correction information from all member drives. A RAID5 volume requires at least 3 disk drives.

Note that if a member drive fails, the rebuild process of a RAID5 volume can take about several days to complete (using 2TB drive members). The rebuild runs in the background, and the rebuild progress is indicated on the volume page.

RAID5

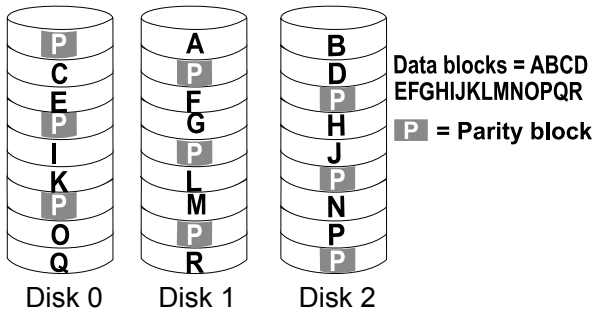

On this configuration window, a "disk" refers to a physical disk drive, a "volume" refers to the logical configuration of disk drives which may include multiple disk drives.

IMPORTANT:

If you remove a disk drive and insert it into a different drive bay, the system will consider it as a new and different disk drive.

Some of the RAID levels provide data protection. Below is the summary of RAID level features:

| RAID level | No. of HDD | No. of HDD failure Allowed | Capacity |
|------------|------------|--|-----------------------------------|
| RAID0 | ≥ 2 | 0 | HDD # x (smallest HDD size) |
| RAID1 | 2 - 4 | 1 or 2 (if counterparts in the mirrored pair survives) | HDD # / 2 |
| RAID5 | ≥ 3 | 1 | (HDD # - 1) x (smallest HDD size) |

The legends used in the Volume list are described below:

| * | # | Disk | RAID | Total size | Available size | Status |
|---|---|---------------|-------------|------------|----------------|--------|
| | 1 | Disk 1,Disk 2 | RAID 0 | 294.3GB | 294.1GB | Online |
| | 3 | Disk 3 | Single disk | 2775.0GB | 2258.2GB | Online |

Selected

(*) **asterisk:** An asterisk symbol indicates that a volume's settings have been modified.

(#) **numbered:** Volume index.

Name: Volume name.

Disk: Member(s) of this volume.

RAID: The RAID level by which this volume was made.

Total size: Total usable capacity size in Gigabytes.

Available size: The unused capacity in Gigabytes.

Status: The statuses can be: New, Online, Offline, Processing, Disabled, Error.

New: Individual disk drives have not been configured into usable storage volumes.

Online: The volume is ready.

Offline: A volume that has fatally failed, or its member drives are missing. Buzzer will be sounded if a volume goes offline. Its sizes will then be indicated as unknown, "---."

Processing: A storage volume configuration is being processed.

Disabled: This volume has been disabled by users.

Error: Configuration or hard drive errors. The volume is invalid, and may need to be manually removed.

Enable volume: It takes several seconds to disable a volume for the need to inform running software and services and flushing cached contents.

Enable volume

To create a storage volume:

1. Click on the **Create...** button. Also check that if all your disk drives are listed. If properly installed, they should all be listed in the Storage - Volume window.

Storage - Volume

Save Create... Delete Advance...

| * | # | Volume | Disk | RAID | Total size | Available size | Status |
|---|---|----------|--------|-------------|------------|----------------|--------|
| | 1 | Volume 1 | Disk 1 | Single disk | --- | --- | New |
| | 2 | Volume 2 | Disk 2 | Single disk | --- | --- | New |
| | 3 | Volume 3 | Disk 3 | Single disk | --- | --- | New |

2. The **Create volume** window will prompt. Select a RAID volume configuration you prefer.

The available disk drives will then be listed. Select their checkboxes to include them into the volume.

The **OK** button will not be available until you select the correct number of disk drives; e.g., 3 or more disks for a RAID5 volume.



3. If you create a RAID volume, the individual disk drives will be grouped into a logical volume as shown below. The creation process should take several minutes, and is indicated in the status bar below.



On completion, video feeds from network cameras are immediately recorded to the created volume(s).

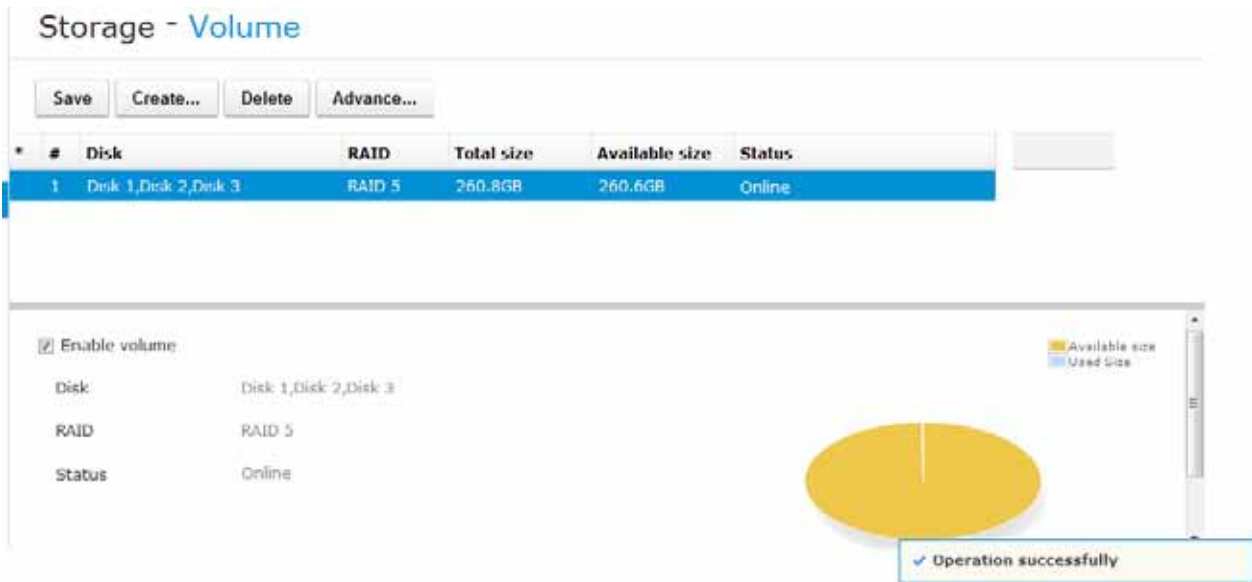

4. Click on the **Save** button to complete your configuration.

To delete a storage volume:

1. Click to select a storage volume from the list.
2. Click on the **Delete** button.
3. A warning message will prompt saying all recorded data will be lost. Click **OK** if you want to remove the volume.

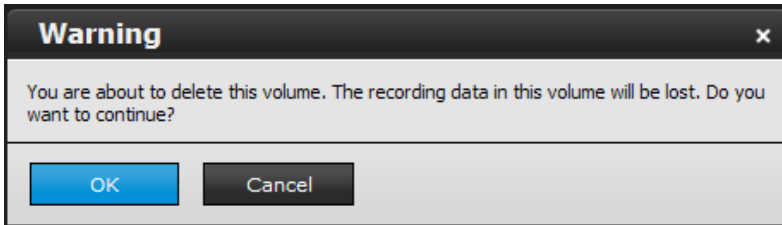

The deletion progress will be indicated as below.

| * # | Disk | RAID | Total size | Available size | Status |
|-----|----------------------|--------|------------|----------------|------------|
| 1 | Disk 1,Disk 2,Disk 3 | RAID 5 | 260.8GB | 258.7GB | Processing |

Enable volume

Disk: Disk 1,Disk 2,Disk 3

RAID: RAID 5

Status: Processing

40%

Available size (Yellow)

Used Size (Blue)

✓ Deletion is under proceeding

When completed, the status of the volume's member drives will be indicated as **"New"** drives. As the result, all recording tasks to that volume will be cancelled.

Storage - Volume

Save Create... Delete Advance...

| * # | Disk | RAID | Total size | Available size | Status |
|-----|--------|-------------|------------|----------------|--------|
| 1 | Disk 1 | Single disk | --- | --- | New |
| 2 | Disk 2 | Single disk | --- | --- | New |
| 3 | Disk 3 | Single disk | --- | --- | New |

⚠ IMPORTANT:

If you want to delete a RAID5 volume with a spare drive, remove the spare drive before you delete the volume.

To rebuild a storage volume:

The precondition is that you have a fault-tolerant storage volume made in a RAID5 or RAID1 configuration. A faulty drive is indicated by the front panel LED or messages in the system logs. The White Volume LED on the drive tray will be turned off.

IMPORTANT:

Please carefully identify which disk drive has failed. **Replacing the wrong drive in a logical volume that already has a failed member will destroy the whole volume.**

1. In System > Logs window, make sure which disk drive has failed. The sample screen shows that Disk [3] has failed. A failed drive can sometimes be indicated as a removed drive.

Logs - System

Export

| # | Level | Date | Source | Message |
|---|-------|---------------------|--------|--------------------|
| 2 | INFO | 2/1/2013 1:36:44 PM | Comet | Disk inserted. [3] |
| 1 | INFO | 2/1/2013 1:27:32 PM | Comet | Disk removed. [3] |

2. Click to select the degraded volume, and then click on the **Advance...** button.

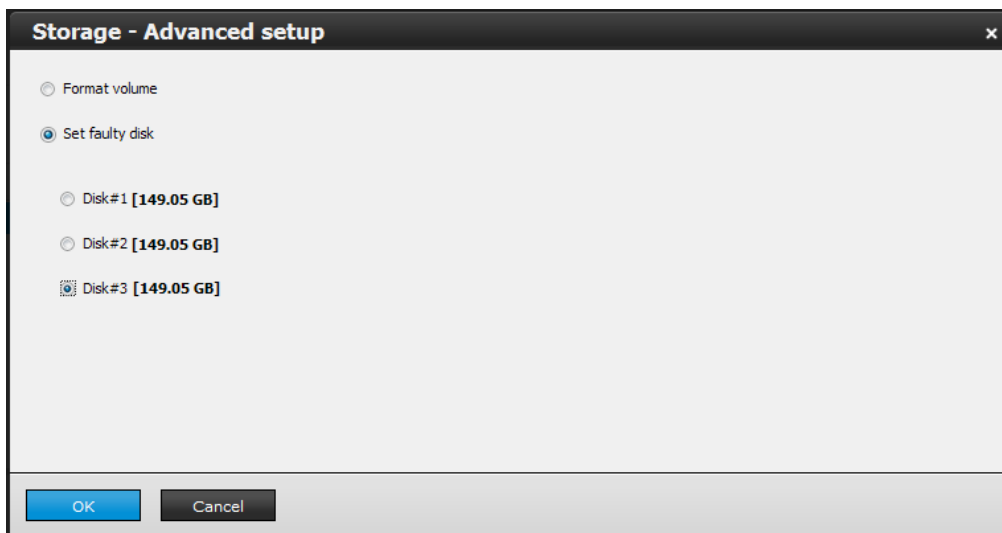

3. Select the faulty drive to set it as "Faulty." Click **OK** to proceed.

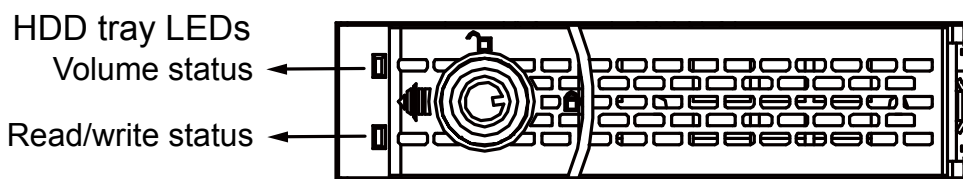

A failed drive or a drive set as faulty will turn off its LEDs or the White I/O LED is off.

On the Volume screen, faulty disk is indicated.

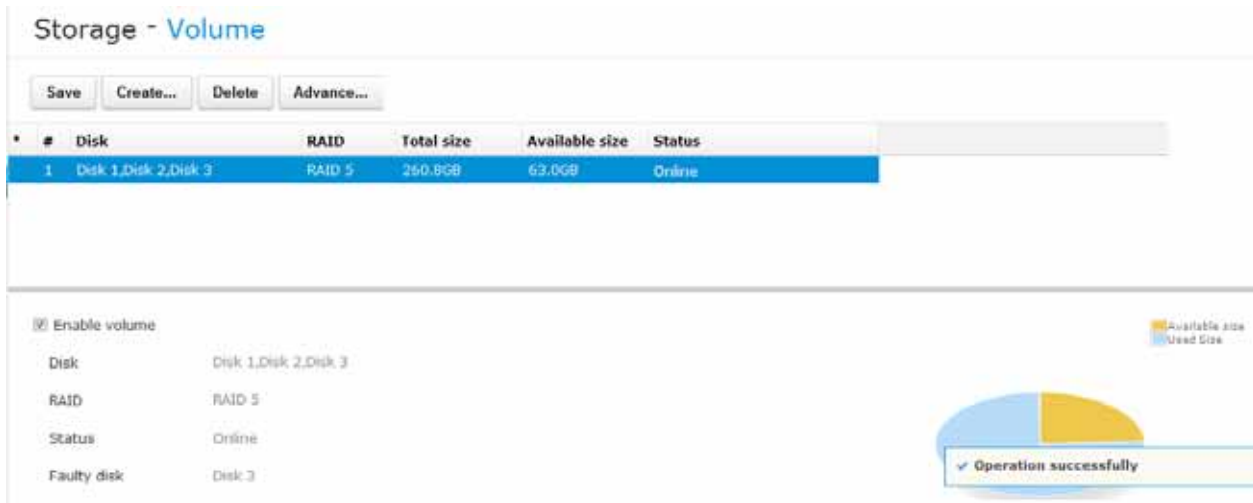

4. Replace the drive indicated as faulty. Open the bezel lock. Flip the door latch to the side and then pull the bezel lever to remove the drive tray. Remove the HDD from the tray and replace it with a new drive.

Bezel Lock

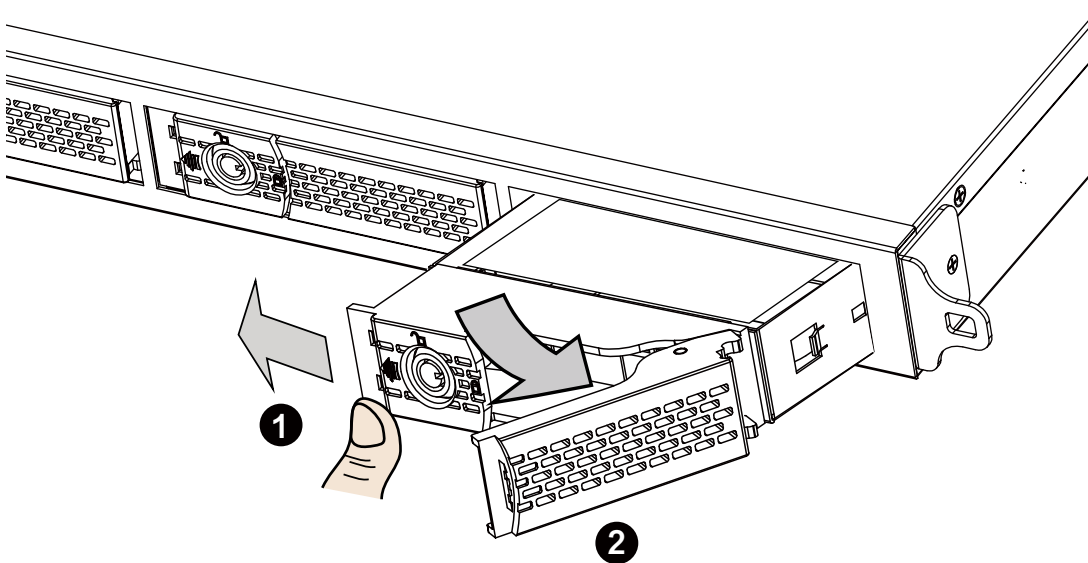
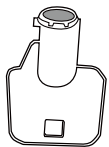
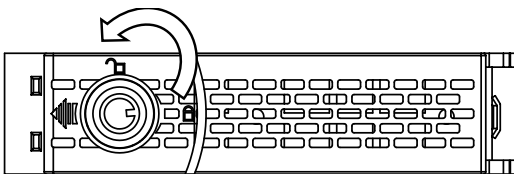

5. Once the replacement disk is installed, click on the **Advance...** button again. Select the replacement drive. Click **OK** to proceed.

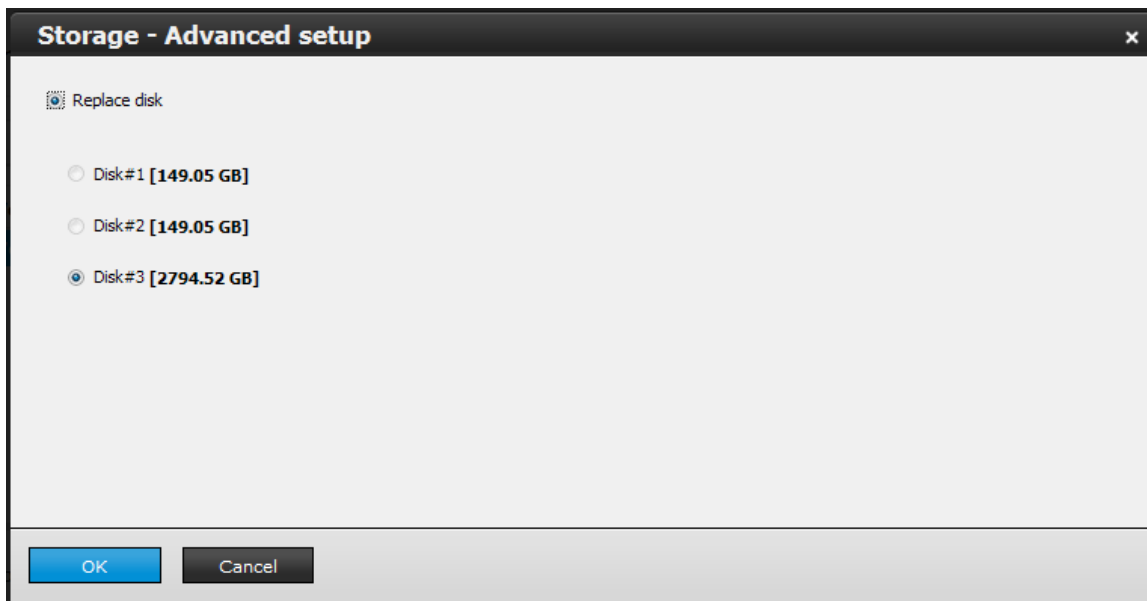

During the rebuild process, further configuration of the volume will become unavailable. The recording tasks will continue during the process. The following message will be shown if you want to configure the volume during a rebuild.

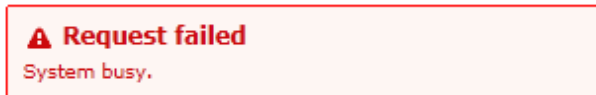

6. The rebuild process will start, and its progress is indicated by a progress bar in the **Status** column.



The rebuild process can last for many hours using today's large capacity disk drives. The rebuild process runs in the background and the recording tasks should continue.

To format a storage volume:

You may also format an existing storage volume in situations such as when you need to re-deploy the system elsewhere.

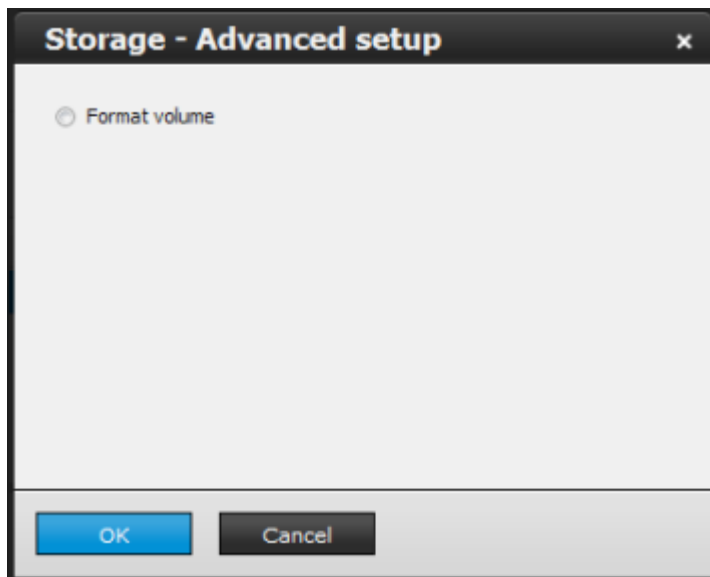

To add or delete a spare disk:

The spare drive option only appears when,

1. A **3-disk RAID5 volume** is available.
2. An unconfigured **new** drive.

A spare disk (or standby disk) can immediately participate in the rebuild of a RAID5 volume, saving the time for replacing a faulty disk. When in the "one-drive-failed" degraded mode, failing another drive will destroy the volume. Using spare disk can reduce the chance of failing yet another member drive.

To add a spare drive to a RAID5 volume,

1. Left-click to select a RAID5 volume, and then click on the **Advance...** button.



2. Select the unconfigured drive, disk #4 in this case, and then click on the **OK** button.

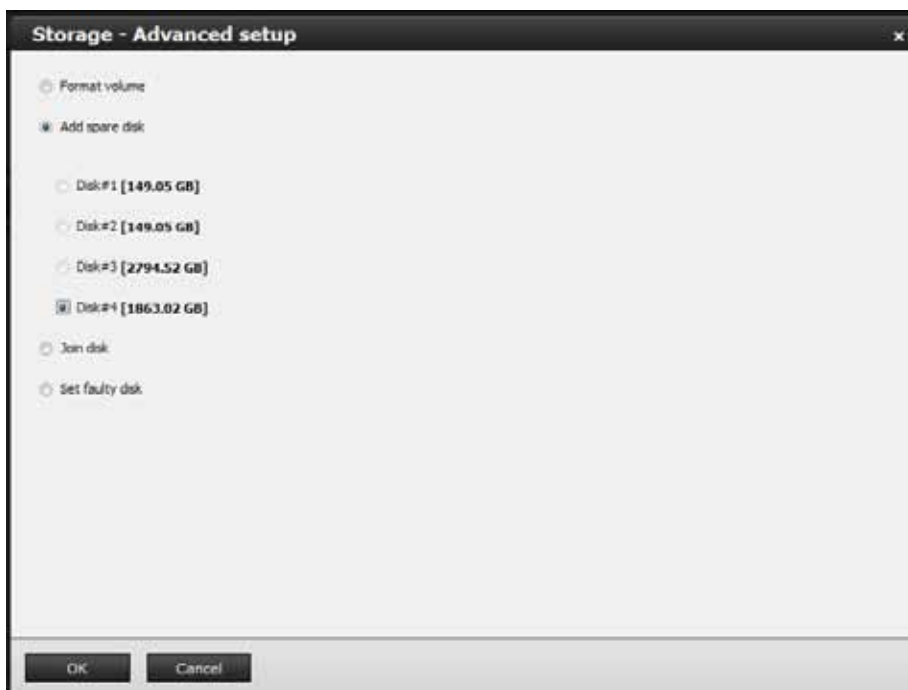

3. The **Add Spare** process will take 3 to 5 minutes to complete, and the progress is indicated in the progress bar below.

Storage - Volume

Save Create... Delete Advance...

| # | Volume | Disk | RAID | Total size | Available size | Status |
|---|----------|------------------------|-------------|------------|----------------|------------|
| 1 | Volume 1 | Disk 1, Disk 2, Disk 3 | RAID 5 | 260.8GB | 260.4GB | Processing |
| 4 | Volume 4 | Disk 4 | Single disk | --- | --- | Processing |

Enable volume

Disk: Disk 1, Disk 2, Disk 3

RAID: RAID 5

Status: Processing

77%

4. On completion, Disk 4 will be listed as a hot spare in the storage volume information.

Storage - Volume

Save Create... Delete Advance...

| # | Volume | Disk | RAID | Total size | Available size | Status |
|---|----------|------------------------|--------|------------|----------------|--------|
| 1 | Volume 1 | Disk 1, Disk 2, Disk 3 | RAID 5 | 260.8GB | 260.0GB | Online |

Enable volume

Disk: Disk 1, Disk 2, Disk 3

RAID: RAID 5

Status: Online

Spare disk: Disk 4

NOTE:

Since RAID0 has no data protection, if a RAID0 volume has a failed member, the **Advanced..** button will not be functional.

Save Create... Delete **Advanced...**

| # | Disk | RAID | Total size | Available size | Status |
|---|----------------|-------------|------------|----------------|---------|
| 1 | Disk 1, Disk 2 | RAID 0 | --- | --- | Offline |
| 3 | Disk 3 | Single disk | 2775.0GB | 2252.6GB | Online |

3-4-2. Storage - Disk

The Disk window provides access to physical disk information, disk physical location, disk health, polling for S.M.A.R.T. statuses, and bad block check.

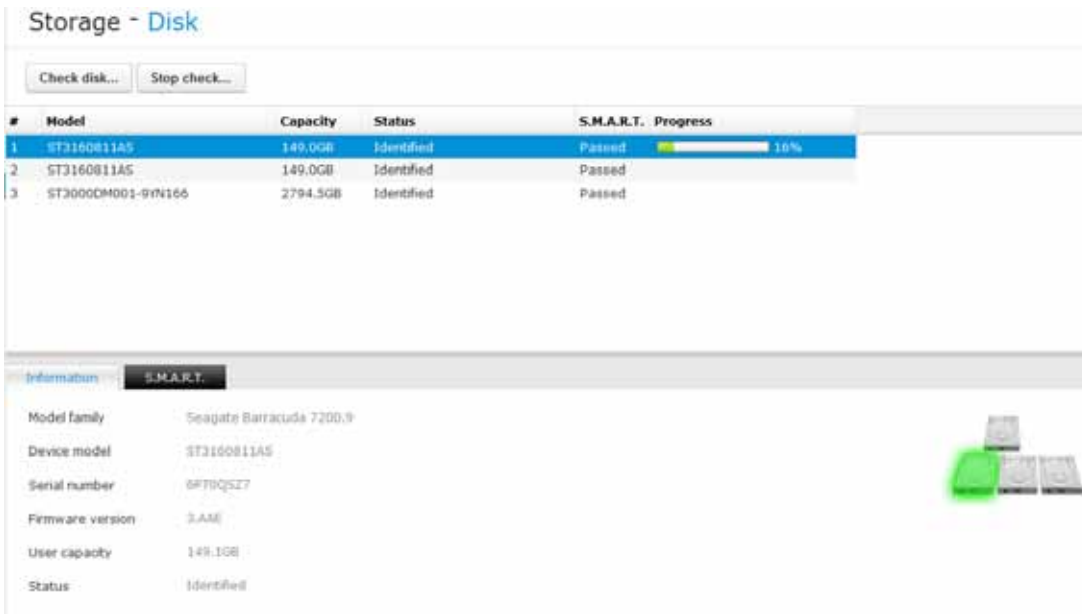

| | | |
|----------------------|--|---|
| (#) numbered: | Disk index. This is determined by their loations in the chassis as shown by the disk location graphics  on the lower right of the screen. | |
| Model: | Disk model name. | |
| Capacity: | Disk capacity in Gigabytes. | |
| Status: | Disk operating status. Can be stated as: | |
| | Connected: | Disk is properly installed, but not yet configured into storage volume. |
| | Identified: | The storage volume this disk belongs to is operating normally. |
| | Corrupted: | Disk is faulty. |
| S.M.A.R.T.: | S.M.A.R.T. status polled from the disk drive. This is not the results from a manually-executed S.M.A.R.T. test. | |
| Progress: | This shows the progress of drive S.M.A.R.T. test or bad block scan. | |

1. Disk Information:

Model family: The brand name of the HDD manufacturer.

Device model: The disk model name.

Serial number: Serial number assigned to the disk drive.

Firmware version: The version of firmware running on this disk drive.

User capacity: The rated capacity for this disk drive.

Status: The bad block check or S.M.A.R.T. test previously executed on this drive.

2. S.M.A.R.T. test:

Attribute: The various attributes can vary from different HDD manufacturers.

Value: Value for the currently selected attribute.

Worst: Worst value acquired for that attribute.

Threshold: A predefined threshold or triggering value. The threshold below which the normalized value will be considered exceeding specifications.

Raw vaule: The detected parameters for that attribute.

Status: The judgement made to deem the current reading as OK or failed.

3. Check disk:

Three types of check disk actions is initiated through this button. Select the action you wish to take and click the OK button.

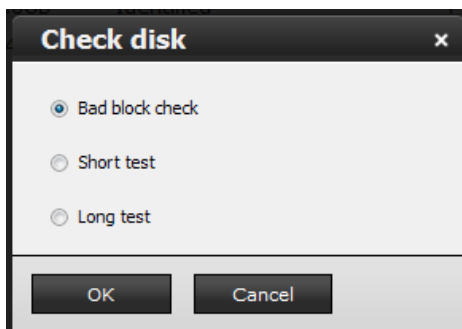

Bad block check: Performs read/write test to drive sectors to locate bad blocks. This action may take several hours to complete.

Short test: Tests the electronic and mechanical performance and disk read performance, including those on disk buffer, read head, seek time, and integrity of drive sectors. The short test is performed on a small section of disk platters, and takes about 2 minutes to complete.

Long test: The long test is more thoroughly and is performed to all drive sectors. The actual completion time depends on drive sizes and the attributes put to test.

The Check disk functions mentioned above, when performed during active I/Os, can consume system resources and cause dropped frames with the recording tasks.

4. Stop check disk:

Stops the bad block check or S.M.A.R.T. test on an individual disk drive. The disk drive currently running a disk check should have a progress bar shown in the Progress column.

3-5. Security

3-5-1. User account

The User account window allows you to create more users, to change user password, and place limitations on users' privileges and administration rights. Up to 16 users can be created, including the default administrator.

1. By default, there are two user groups: **Administrator** and **Normal user**.
2. The normal users can not access the **Settings** window, meaning that normal users can not add or remove cameras, make changes to alarm, network, and all other system settings. When a normal user tries to access the system Settings window, the following message will prompt.

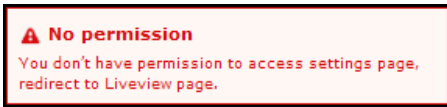

3. The administrator users can access all cameras recruited in the configuration; while the normal users can be configured to have access to some or all cameras.
4. The system blocks out the video feeds from users who are denied of the access to particular cameras. The alarms and the alarm-triggered recordings from those cameras will also be inaccessible for unauthorized users.

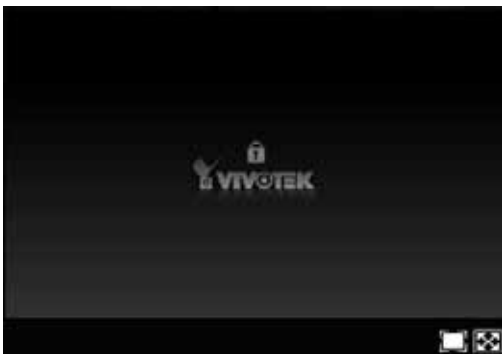

To create users,

1. From the Security > User account window, click on the **Create...** button.

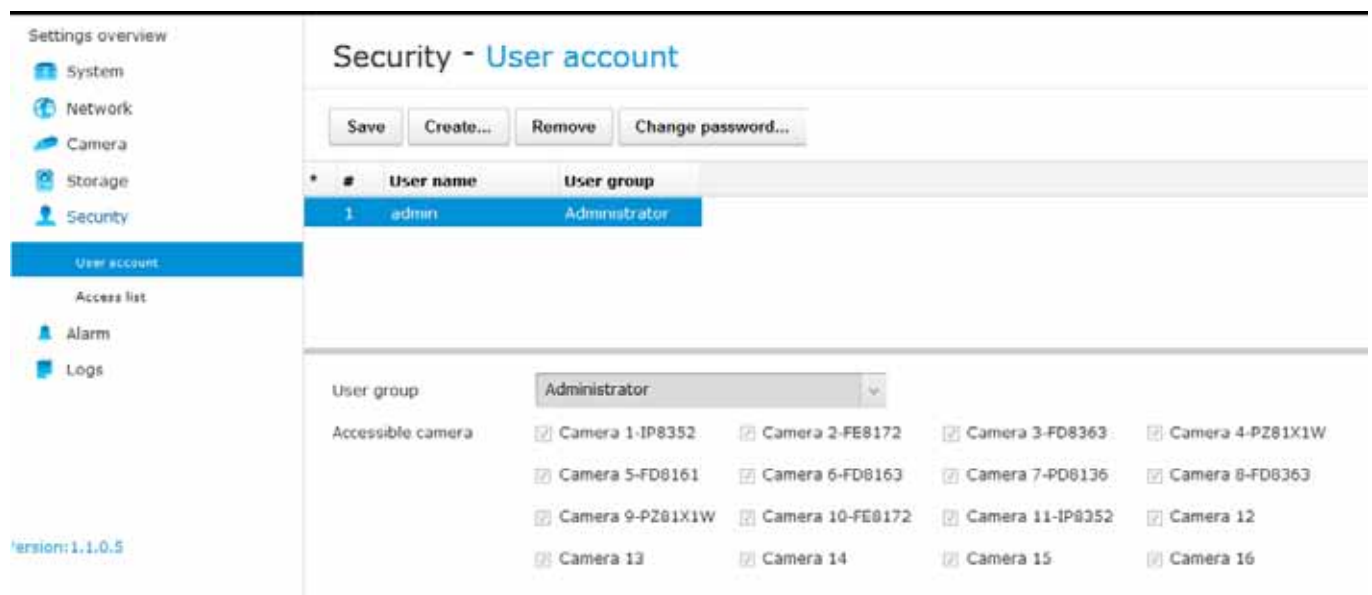

Settings overview

- System
- Network
- Camera
- Storage
- Security
- User account**
- Access list
- Alarm
- Logs

Version: 1.1.0.5

Security - User account

Save Create... Remove Change password...

| # | User name | User group |
|---|-----------|---------------|
| 1 | admin | Administrator |

User group: Administrator

Accessible camera

| | | | | | | | |
|-------------------------------------|------------------|-------------------------------------|------------------|-------------------------------------|------------------|-------------------------------------|------------------|
| <input checked="" type="checkbox"/> | Camera 1-IP8352 | <input checked="" type="checkbox"/> | Camera 2-FE8172 | <input checked="" type="checkbox"/> | Camera 3-FD8363 | <input checked="" type="checkbox"/> | Camera 4-PZ81X1W |
| <input checked="" type="checkbox"/> | Camera 5-FD8161 | <input checked="" type="checkbox"/> | Camera 6-FD8163 | <input checked="" type="checkbox"/> | Camera 7-PD8136 | <input checked="" type="checkbox"/> | Camera 8-FD8363 |
| <input checked="" type="checkbox"/> | Camera 9-PZ81X1W | <input checked="" type="checkbox"/> | Camera 10-FE8172 | <input checked="" type="checkbox"/> | Camera 11-IP8352 | <input checked="" type="checkbox"/> | Camera 12 |
| <input checked="" type="checkbox"/> | Camera 13 | <input checked="" type="checkbox"/> | Camera 14 | <input checked="" type="checkbox"/> | Camera 15 | <input checked="" type="checkbox"/> | Camera 16 |

2. Select a User group by unfolding its pull-down menu. Select either an Administrator or normal user as the user group.

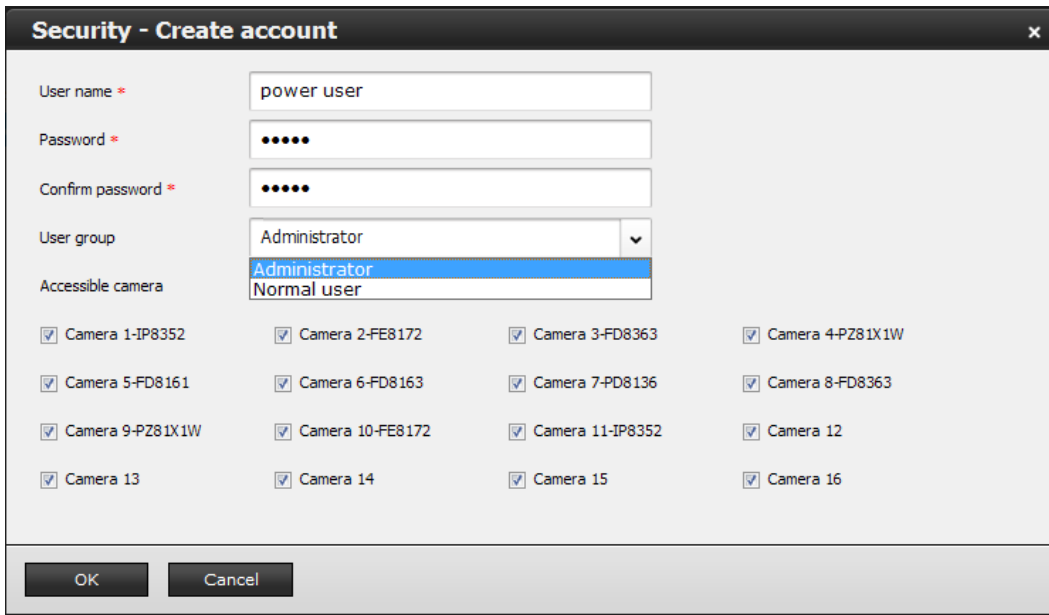

3. Enter the User name and password. The max. number of characters for a user name is 64, with alphabetic and numeric characters including [0-9][a-z][A-Z][_][][-].[,][@]. The max. number for password is also 64.
4. If you are creating a normal user with limited access to cameras, deselect the checkboxes in front of the cameras to deny the user access.
5. Click **OK** to close the configuration window. Repeat the process to create more users, and please remember to click the **Save** button to preserve your configuration after you created all users.

To remove users,

1. From the **Security > User account** window, left-click to select an existing user.
2. Click on the **Remove** button.
3. The user's entry will appear in lighter color with a strike-through to distinguish it as a deletion that has not been applied.

Security - User account

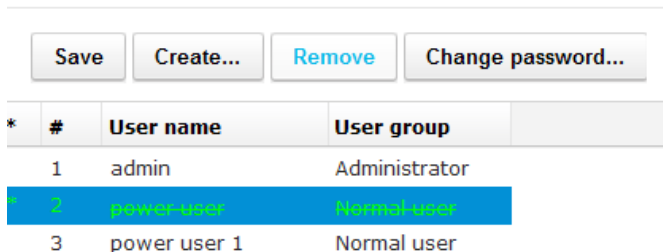

4. Click on the **Save** button, and then the deletion will actually take place.

To change the password for an existing user,

1. From the Security > User account window, click on an existing user.
2. click on the **Change password...** button.
3. The password prompt will appear. Enter the new password twice and click **OK** to confirm.



4. The user's entry will appear in a lighter color and an asterisk mark in front to distinguish it as a changed entry that has not been applied.

Security - User account

Save Create... Remove Change password...

| * # | User name | User group |
|-----|--------------|---------------|
| 1 | admin | Administrator |
| * 2 | power user | Normal user |
| * 3 | power user 1 | Normal user |

5. Click **Save** to preserve your changes on the screen.

3-5-2. Access list

The access control applies to the access from a web client over HTTP and RTSP protocols. Three access configuration options are available:

1. **Allow all:** Allows access from all IP addresses.
2. **Allow only:** Allows access only from the listed IPs. You should manually enter the IPs for computers that need to access the NVR.

Note that you can use the asterisk (*) mark to represent all decimal numbers in each individual octet of the range of IP address: such as using 172.16.0.* for addresses ranging from 172.16.0.1 to 172.16.0.254.

A decimal number between two asterisks, e.g., <172.*.10.*>, is considered as invalid.

Security - Access list

Save

Security access list

Allow all

Allow only

Allow address list

IP address

Deny only

3. **Deny only:** Denies the access from the listed IPs. You should manually enter the IPs for computers that will be blocked out from the access. The configuration details is the same as those for the Allow only methodology.

3-6. Alarm

3-6-1. General

The events reported from individual cameras' digital inputs, digital outputs, and motion detection can be accommodated in the NVR system's alarm settings. The NVR also comes with DI and DO pins. These events will then be reported or commanding to trigger corresponding actions as follows:

1. Reporting events via Email or system buzzer.
 2. Triggering video snapshot and text message by the occurrences of events to an FTP/HTTP site.
 3. Triggering the camera(s) for its lens to move to a preset position.
 4. Triggering the cameras' or the NVR's digital output.
 5. Alerting the administrator with alarms indicators on the Alarm panel.
- You can create up to 16 instances of alarm.

Hardware connections to DIs or DOs, e.g., window sensors, should be made separately. The motion detection configuration is also made via a web console with individual cameras.

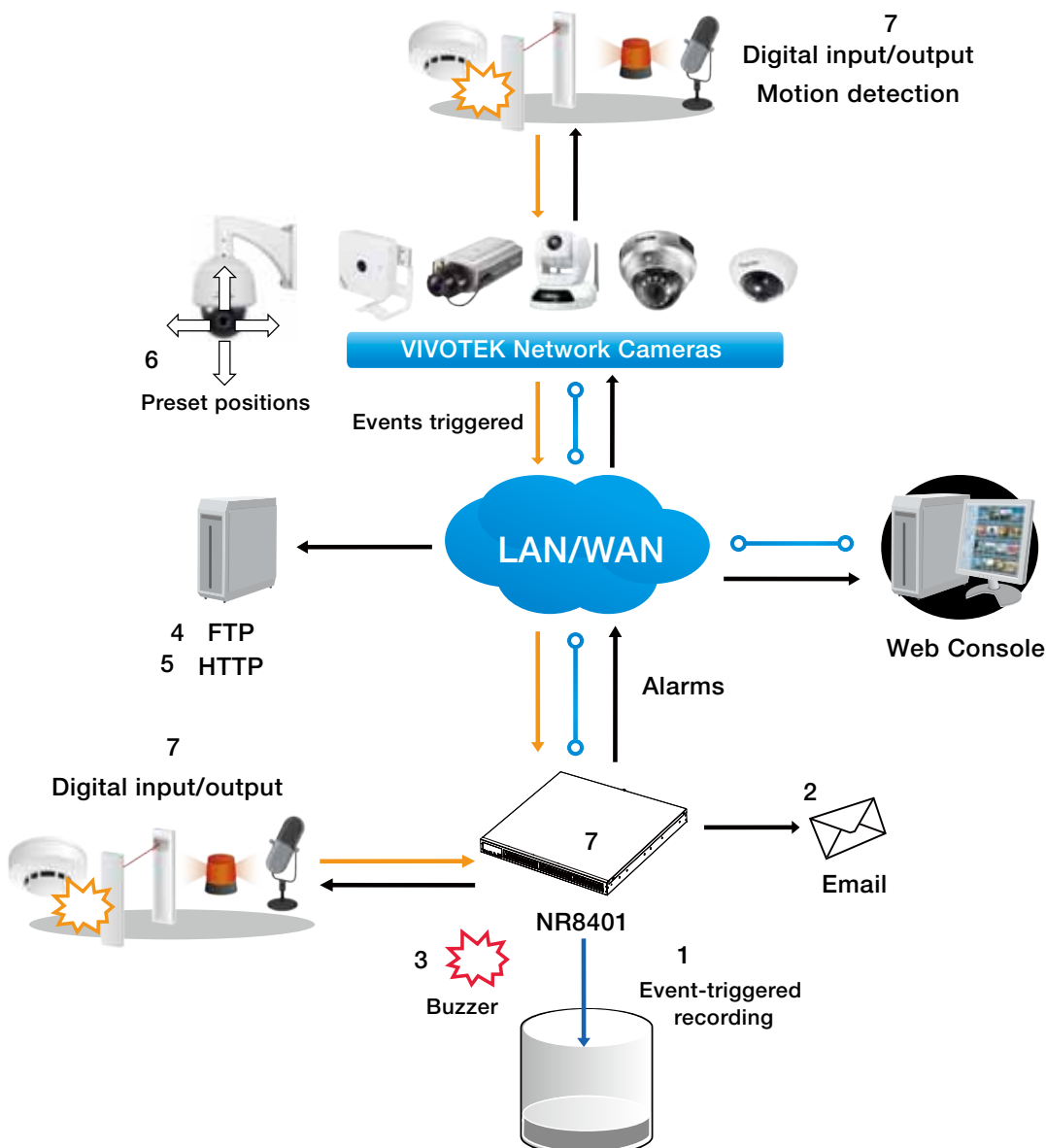

Below is a glimpse of alarm sources and alarm actions:

| Sources | | Actions | |
|------------------|---|----------------------|-----------------|
| DI | ▶ | Video recording | ▶ video footage |
| DO | | Email | ▶ snapshots |
| Motion detection | | Buzzer | |
| | | FTP | ▶ snapshots |
| | | HTTP | ▶ messages |
| | | Camera preset points | |
| | | Camera/NVR DO | |

To create an alarm,

1. Click on the **Create...** button.

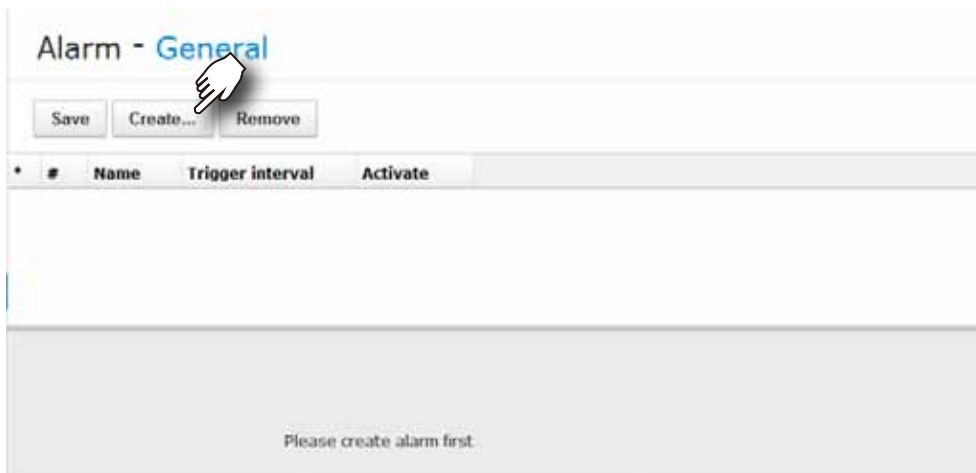

2. The **Create Alarm** wizard window will prompt. You can manually enter a name for the current setting. You can enter up to 16 numeric or alphabetic characters for the name, including symbols such as [0-9][a-z][A-Z][_][]. You can also designate the interval between one alarm and the next triggered alarm to avoid the situation that the alarms can be too frequently triggered.

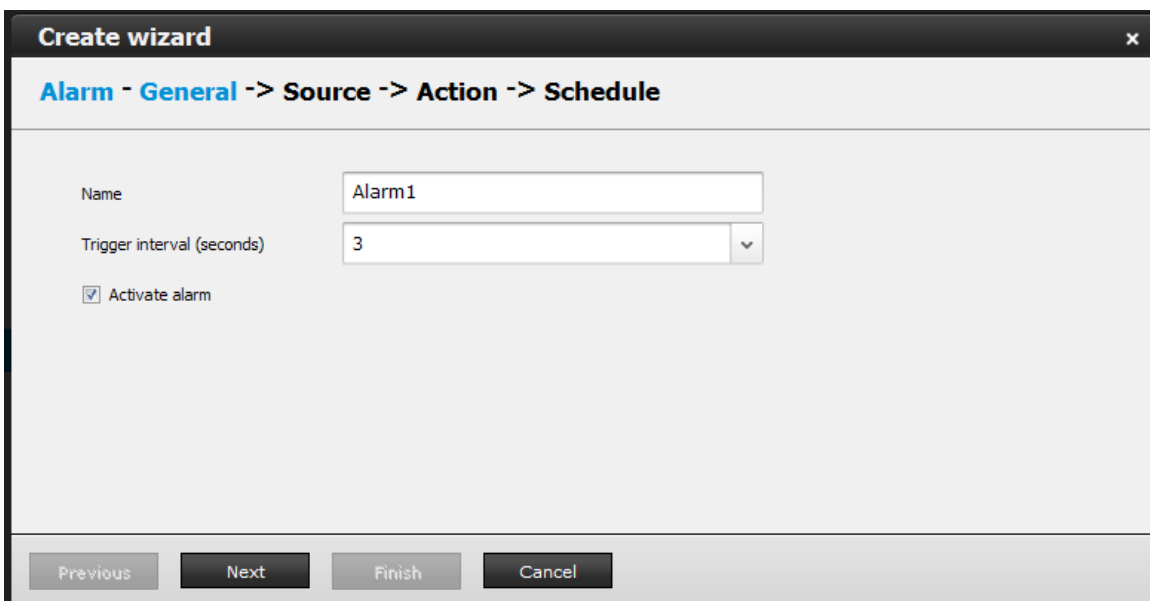

The **Activate alarm** checkbox is selected by default. Click on the **Next** button to proceed.

- On the **Source** window, select one or more cameras by selecting its checkboxes. The number of DI or DOs on each camera is automatically detected and displayed through individual checkboxes. The **Motion detection** function, if there are many detection windows configured on a camera, is all triggered by one checkbox.

Note that the triggering sources will be listed even if the camera is currently not connected.

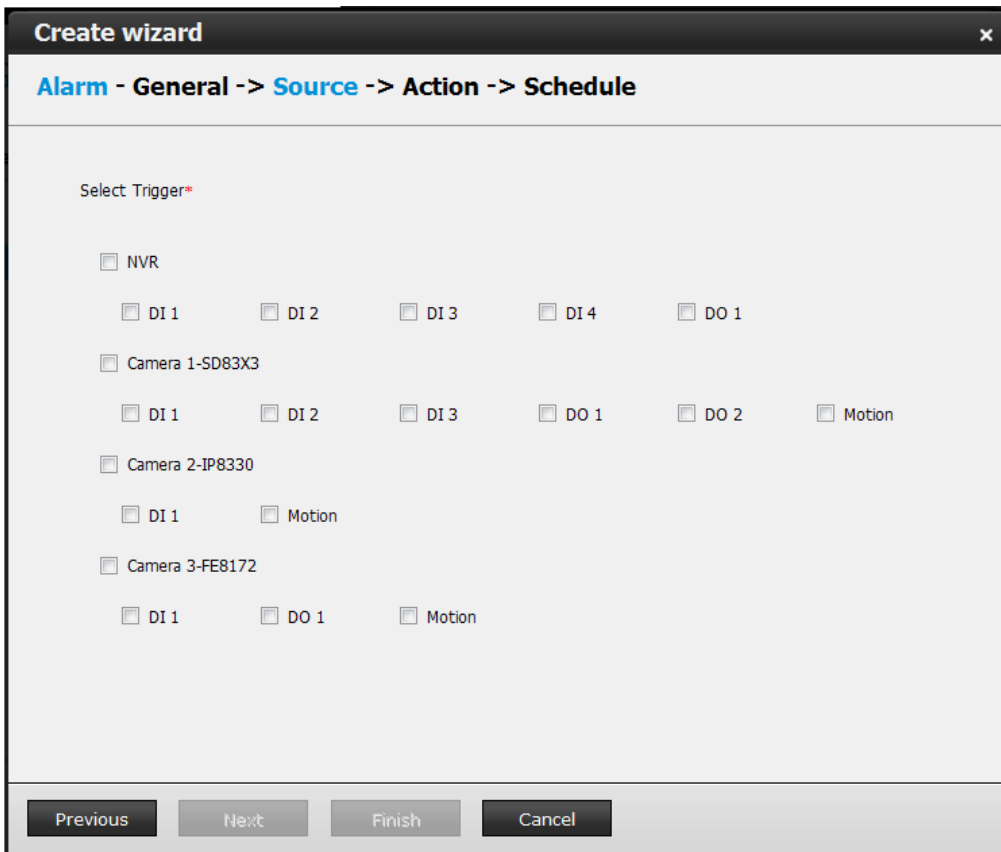

4. On the **Action** window, you can select the Action type from a drop-down menu. The configuration details of each action type is discussion below.

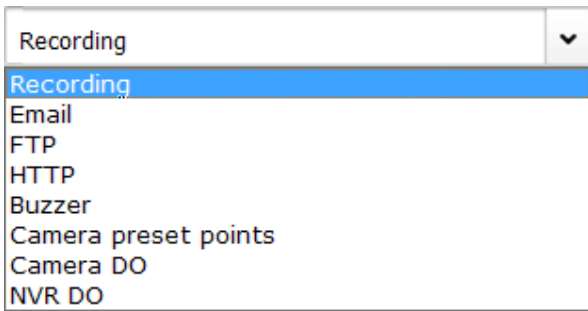

4-1. **Recording** - When an event is triggered, the selected camera will record a video footage of the length defined by the pre-/post-event setting, to the NVR system. See below for an **Alarm playback** window.

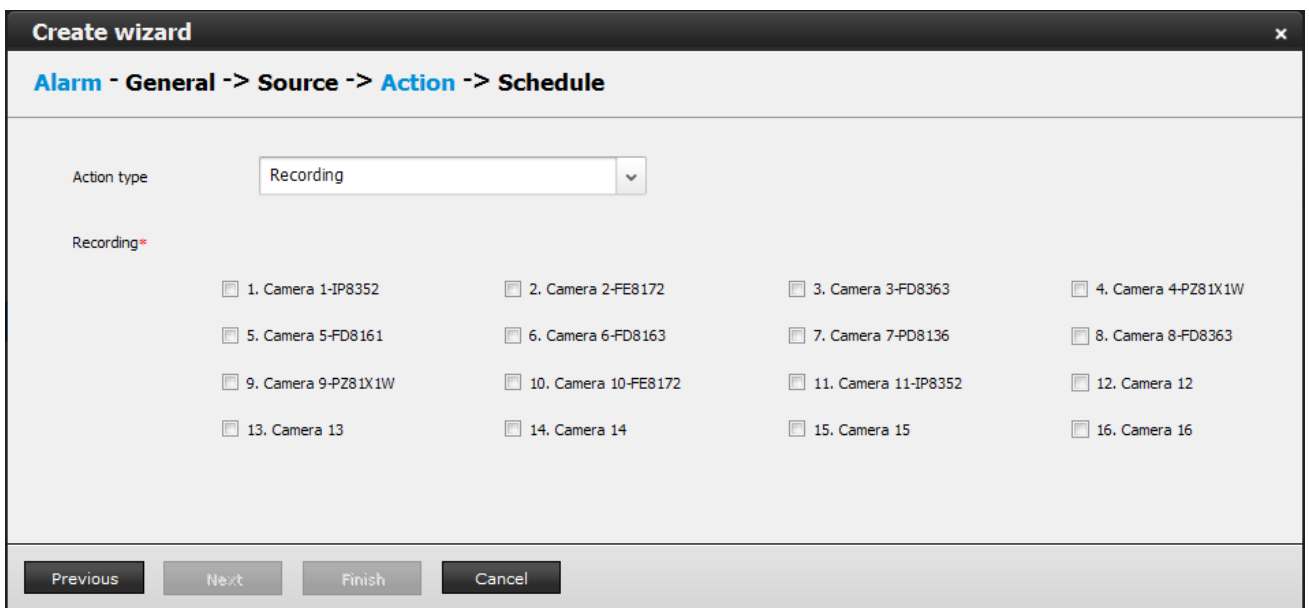

Once an alarm is triggered, it is listed on the **Alarm panel** on the **Liveview** window. See page 45 for details about the functions of alarm panel and the alarm playback function.

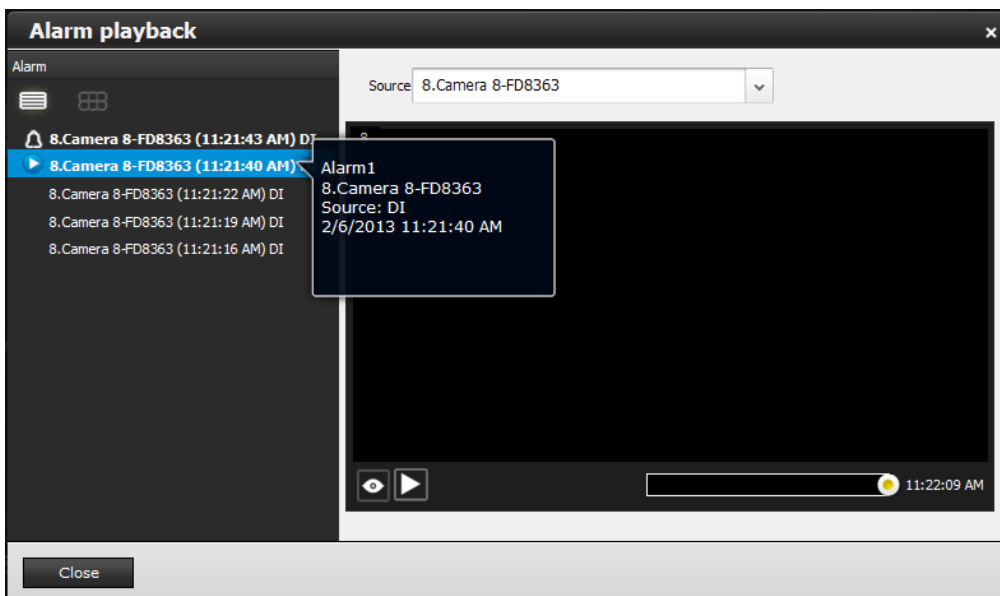

4-2. **Email** - The Email action sends an Email to the administrator along with a snapshot of the event.

To configure Email notification, enter valid Email addresses as the Sender and Recipient addresses, an Email subject, and the SMTP server address through which the Email will be delivered. If you need to log in to SMTP server to deliver an Email, enter the User name and password for access to that account.

The Email subject and addresses can be composed of 254 characters in numeric or alphabetic characters including: [0-9][a-z][A-Z][_][][-][.][,][@]. You can enter the addresses of multiple recipients. Use semicolons, (;), to separate the addresses of multiple recipients.

Select the checkboxes below for which camera's snapshots will be sent along with the Email.

The file names of the snapshot jpeg files will look like this:
[MAC]_[DATE]_[TIME]_[CAMERA_INDEX].jpg

4-3. **Buzzer** - The buzzer is sounded on the occurrence of the event. The buzzer tones are categorized into: **Major** (1 long 2 shorts), **Normal** (3 shorts), and **Minor** (2 shorts) depending on the importance of an event. Select a Buzzer modulation from the drop-down list. A long tone has a duration of 1 second, while a short tone 0.5 second.

Select how many times the buzzer tones will be repeated on the occurrence of an event.

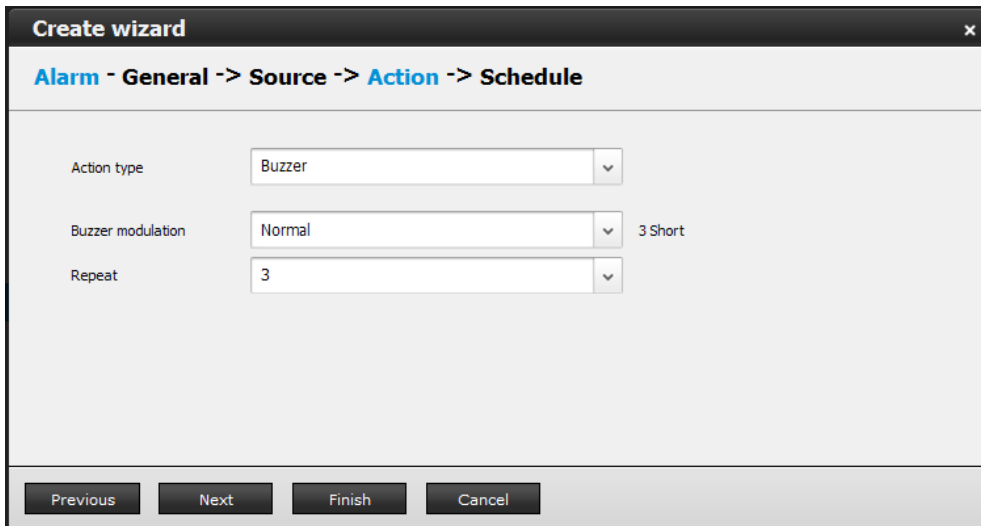

If events of different importance are issued at the same time, e.g., one major and one minor event, system will ignore the minor event and sound the buzzer tone for the major event only. The buzzer can be sounded either by the Alarm actions or the system events. If Alarm actions and system service events occur at the time, Alarm actions have the higher priority.

If multiple Alarm actions occur, the currently-sounded events can be depleted by the new event.

NOTE:

If system buzzer is sounded, turn it off in **Settings > Logs > Error** page. Click the **Stop buzzer sound** button.

Serious system faults, such as a missing volume, can trigger the system buzzer. Verify the cause of system fault and turn off the buzzer.

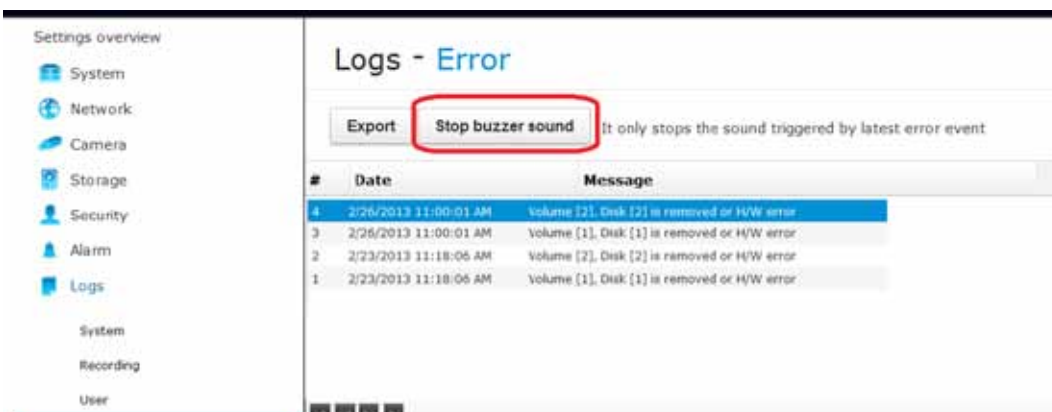

4-4. **FTP** - Snapshots from specified cameras can be uploaded to an FTP site on the occurrence of an event. Enter the FTP site address in the dotted-decimal notation, e.g., 159.22.151.20. Enter the login name and password for the user account. You can enter a directory name you prefer on the FTP site. The server port default is 21, a different number between 1025 and 65535 can also be assigned.

If authentication is not applied, login will proceed using the [anonymous] account. The file names of the snapshot jpeg files will look like this:
[MAC]_[DATE]_[TIME]_[CAMERA_INDEX].jpg - If similar files already exist, an additional index number will be added to the end of file name.

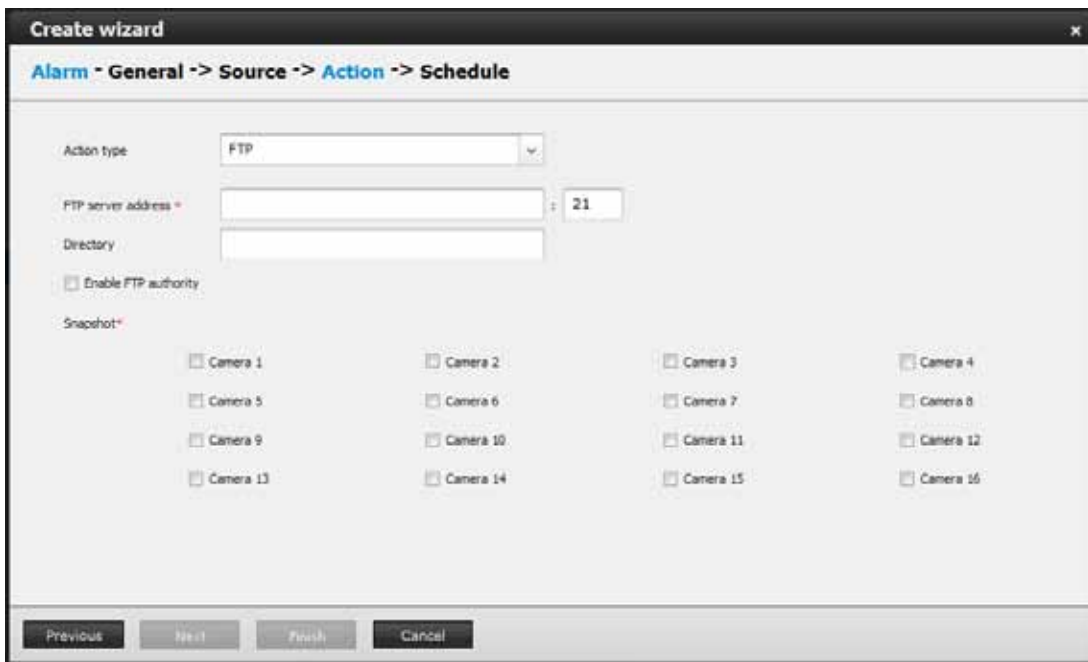

The screenshot shows a 'Create wizard' dialog box with the 'Action' tab selected. The 'Action type' is set to 'FTP'. The 'FTP server address' field is empty, and the 'Port' is set to '21'. The 'Directory' field is also empty. There is an unchecked checkbox for 'Enable FTP authority'. Under the 'Snapshot' section, there are 16 checkboxes labeled 'Camera 1' through 'Camera 16', all of which are currently unchecked. At the bottom of the dialog, there are four buttons: 'Previous', 'Next', 'Finish', and 'Cancel'.

4-5. **HTTP** - An event message is sent to an HTTP server on the occurrence of an event. The URL format for the HTTP server address is `http://host[:port][abs_path]`. The applicable characters for the `abs_path` are: `[0-9][a-z][A-Z][-.:/][?][&][@][_][=]`.

If you need to log in to HTTP server, enter the User name and password for access to that account.

The user name can be composed of 64 numeric or alphabetic characters and symbols including `[0-9][a-z][A-Z][_][][-].[,]`.

The screenshot shows a 'Create wizard' window with a dark title bar and a close button. The main area has a breadcrumb trail: 'Alarm - General -> Source -> Action -> Schedule', with 'Action' highlighted in blue. Below this, there are several input fields: 'Action type' is a dropdown menu showing 'HTTP'; 'URL *' is a text box containing 'http://192.168.4.141:80'; 'Enable HTTP authority' is a checked checkbox; 'User name *' is a text box containing 'user'; and 'Password *' is a text box with seven dots. At the bottom, there are four buttons: 'Previous', 'Next', 'Finish', and 'Cancel'.

4-6. **Camera preset points** - A PTZ capable camera can move its lens to the preset position in case of a triggered alarm. For example, a triggered sensor may indicate an area of interest has been intruded, and a camera's field of view should be moved to cover that area. The precondition is that you properly set up preset positions on your PTZ cameras.

The screenshot shows a 'Create wizard' dialog box with a close button (X) in the top right corner. The breadcrumb path is 'Alarm - General -> Source -> Action -> Schedule'. The 'Action' step is highlighted in blue. The form contains three dropdown menus: 'Action type' set to 'Camera preset points', 'Camera' set to '7.Camera 7-PD8136', and 'Preset location' set to 'lower left'. At the bottom, there are four buttons: 'Previous', 'Next', 'Finish', and 'Cancel'.

4-7. **Camera DO** - A triggered alarm triggers a camera's DO, e.g., an alarm siren.

The screenshot shows a 'Create wizard' dialog box with a close button (X) in the top right corner. The breadcrumb path is 'Alarm - General -> Source -> Action -> Schedule'. The 'Action' step is highlighted in blue. The form contains three dropdown menus: 'Action type' set to 'Camera DO', 'Camera' set to '8. Camera 8-FD8363', and 'DO' set to '1'.

4-8. **NVR DO** - A triggered alarm triggers the NVR's DO, e.g., an alarm siren.

The screenshot shows a 'Create wizard' dialog box with a close button (X) in the top right corner. The breadcrumb path is 'Alarm - General -> Source -> Action -> Schedule'. The 'Action' step is highlighted in blue. The form contains two dropdown menus: 'Action type' set to 'NVR DO' and 'DO' set to '1'.

- On the **Schedule** page, you can select to activate or de-activate alarm triggers throughout a specific time. For example, in some situations you can disable the alarm triggers during the office hours, and choose to enable the triggers only during the off-office hours.

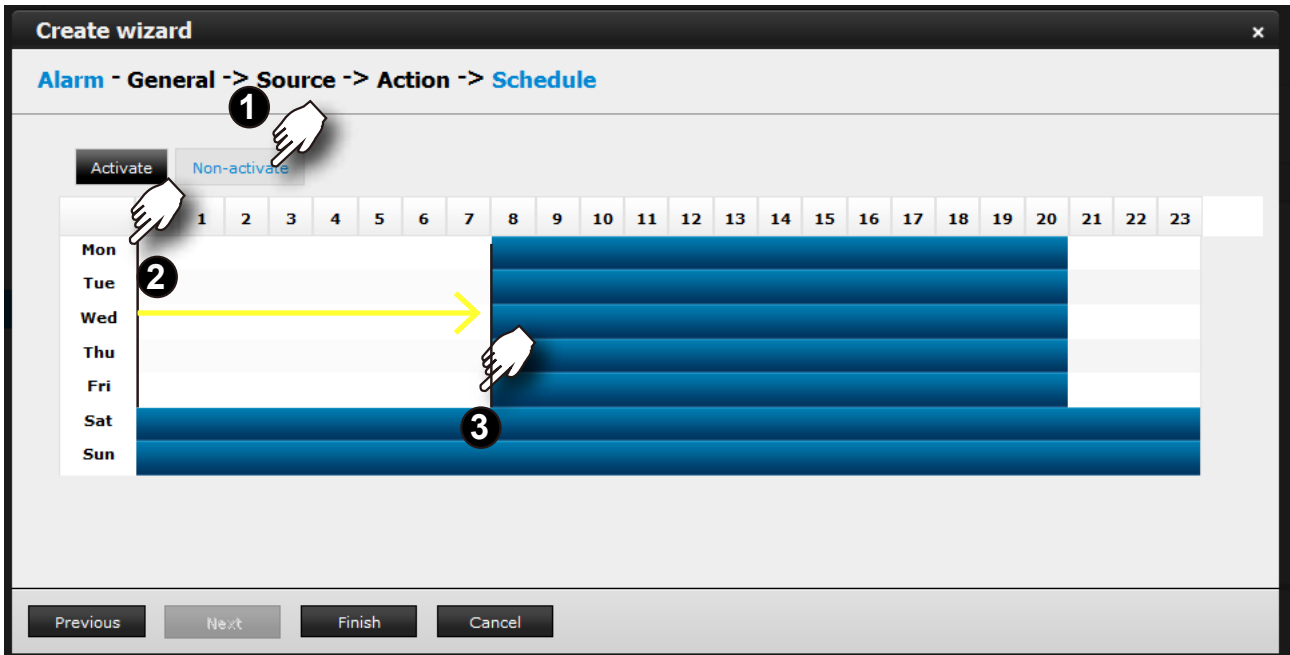

- Click **Finish** to end the configuration. A configured instance will appear in lighter color and an asterisk mark in front to distinguish it as a changed entry that has not been applied.

Alarm - General

Save Create... Remove

| * # | Name | Trigger interval | Activate |
|-----|--------|------------------|----------|
| * 1 | Alarm1 | 3 | Enable |
| 2 | Alarm2 | 3 | Enable |
| * 3 | Alarm3 | 3 | Enable |

- Click **Save** to preserve and enable your alarm setting.
- Repeat the process above to create more alarms according to the needs in your surveillance deployment.

3-6-2. Editing Alarms via Source, Action, and Schedule

1. Editing an existing instance -

1-1. To remove an existing alarm, select by a left-click, and then click on the **Remove** button.

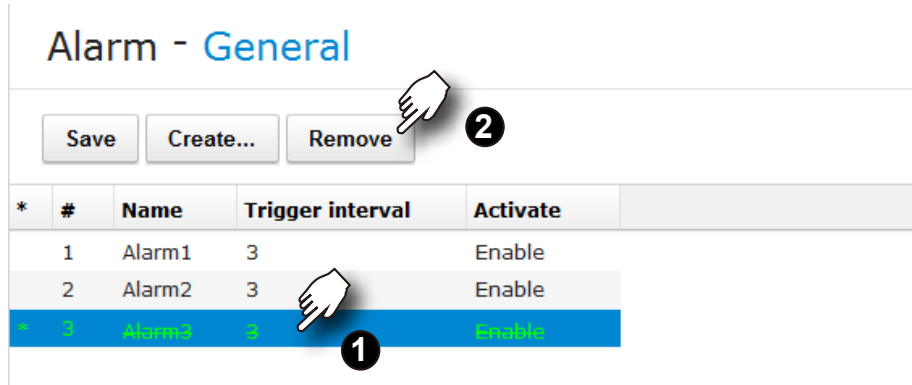

1-2. To edit an existing alarm, select by a left-click, and then click on the **Source**, **Action**, or **Schedule** button on the left function tree. The associated parameters will display on different windows. You can then edit the previous configuration such as selecting a different triggering source, reactive action, or time span on a schedule.

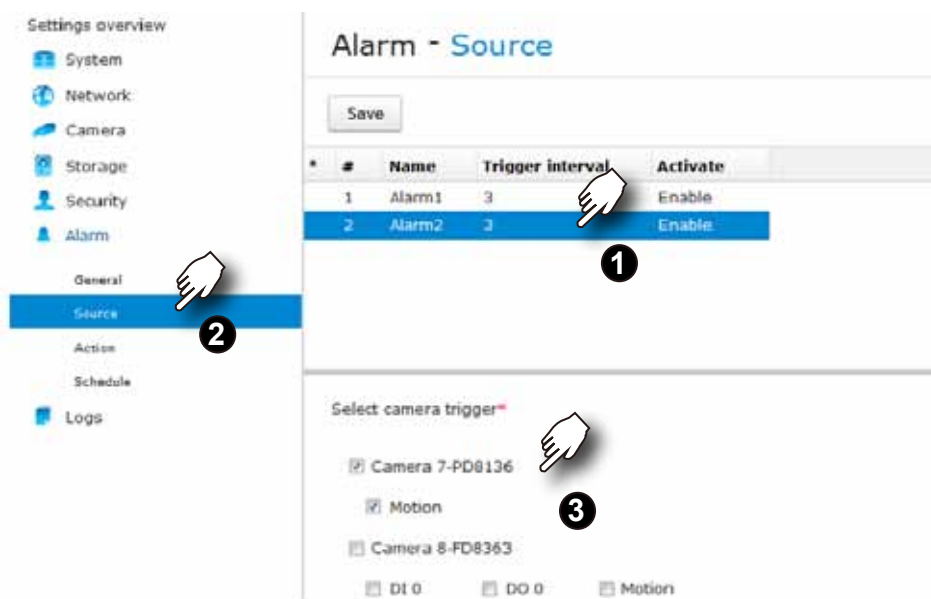

While in the editing window, the Create and Remove buttons are not available.

3-6-3. Alarm - History

The History window provides access to search for past alarms.

You can designate your search criteria by the triggering devices, by the time of occurrence, or by the Event types such as Motion detection, DI, or DO. Note that the time search can only be dated back to 180 days ago.

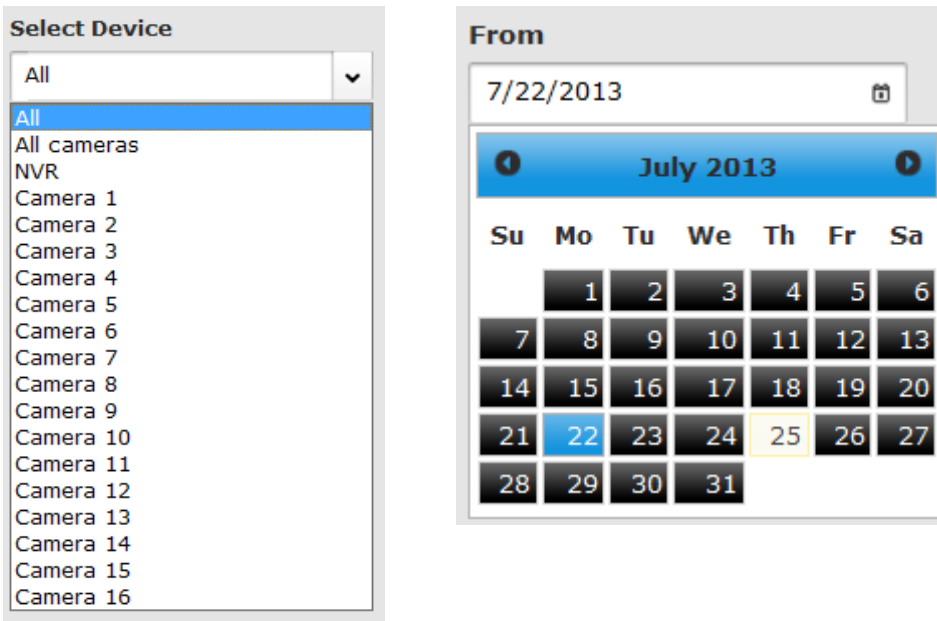

The search results will be listed on the right with index number, time of occurrence, alarm name, and the Event type. The search results will display up to 200 entries. The outdated entries will be depleted.

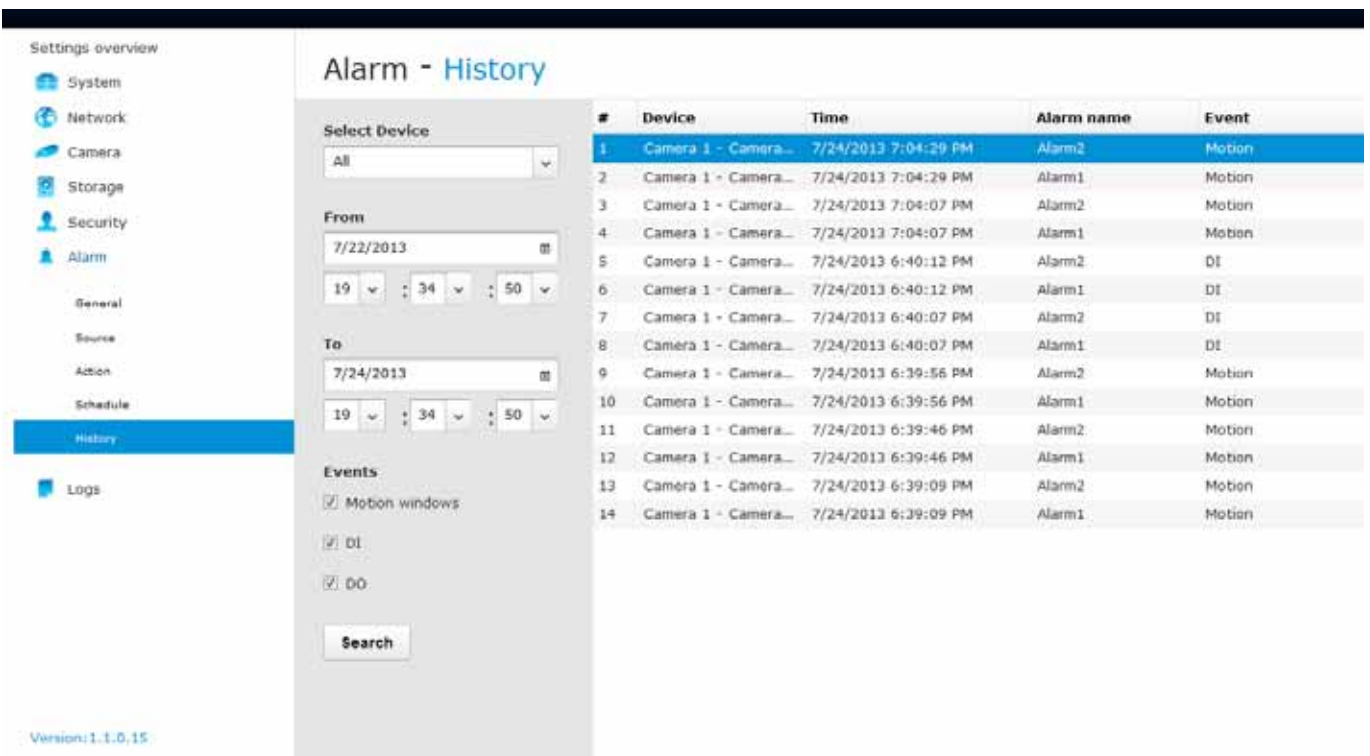

3-7. Logs

By defaults, system logs will be written to every disk drives installed into the system. Up to 10,000 event logs will be kept with a segmented disk section within each drive. Old logs will be automatically removed if exceeding the 10,000 threshold.

The logs related functions include:

1. **Export** button: This button can be used to export the current event logs in the CSV format. The default export file name is [MAC]_[DATE]_[TIME].csv. For example, an exported file may look like this: 0002D1112233_20130222_011013.csv.
2.  Page selector buttons: (from left to right) First page, Previous page, Next page, and the Last page.
3. **Page size: 20 50 100 200** Page size buttons: These buttons determines how many event logs will be displayed on a single page. The selected number will be displayed without the underline.

The event logs fall into he following categories: **System**, **Recording**, **User**, and **Error**. A click on each category brings out a list of event logs belonging to that category.

| Logs | | | |
|-----------|----|----------------------|----|
| System | 22 | 2/19/2013 3:27:44 PM | 11 |
| Recording | 21 | 2/19/2013 3:27:44 PM | 9 |
| User | 20 | 2/19/2013 3:27:44 PM | 14 |
| Error | 19 | 2/19/2013 3:27:44 PM | 13 |
| | 18 | 2/19/2013 3:27:43 PM | 10 |
| | 17 | 2/19/2013 3:27:41 PM | 3 |
| | 16 | 2/19/2013 3:27:40 PM | 6 |
| | 15 | 2/19/2013 3:27:40 PM | 7 |

Usually the Error events can trigger the onboard buzzer. Use the **Stop buzzer sound** button to mute the buzzer. The will buzzer will still be sounded if the system is powered off and then powered on until the errors can be corrected, such as a missing volume.

The following information is shown with each event log:

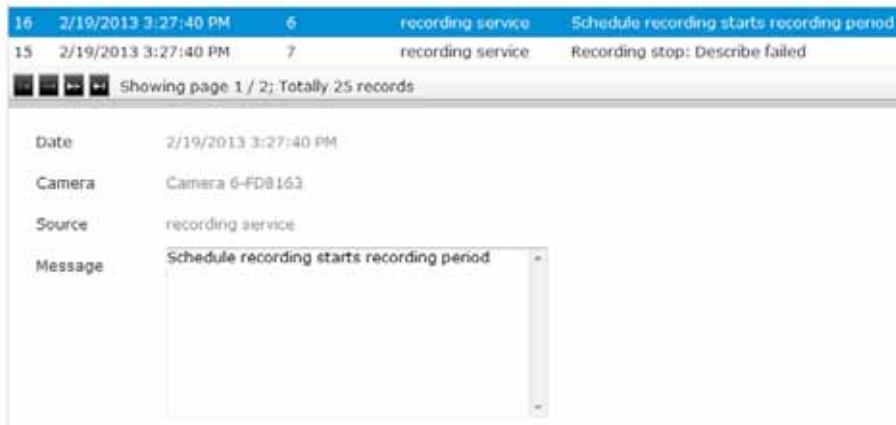

1. **Level:** The following severity level can be applied to an event.
 - 1-1. **Error:** Configuration errors such as lack of system memory or a faulty camera password.
 - 1-2. **Info:** General information such as acquiring an IP from DHCP server.
 - 1-3. **Warning:** Configuration and operation errors such as re-starting server service.
 - 1-4. **Config:** Events that are generated due to configuration changes, such as a change in address or that to a camera configuration.

Below are some sample messages:

| Event | Level | Source | Message |
|--------------------|-------|------------------|--|
| DHCP renew address | Info | [service name] | DHCP renew: interface: [interface] Address: [IP address] Subnet mask: [subnet mask] Gateway: [gateway] |
| DDNS result | Info | [service name] | DDNS result: [OK/Failed] |
| Reboot | Info | User: [username] | System reboot |
| System shutdown | Info | Power button | System shutdown |
| Restore | Info | User: [username] | Restore configuration |
| NTP time update | Info | [service name] | NTP time update: [time offset] |
| Disk insert | Info | [service name] | Disk inserted. [disk id] |
| Disk remove | Info | [service name] | Disk removed. [disk id] |
| Firmware upgrade | Info | User: [username] | Firmware upgrade |
| Recycle start | Info | [service name] | Recycle start: [volume name] [volume size] [volume free] |
| Recycle start | Info | [service name] | Recycle finish: [camera id] [expired date] [recycle date] |

| | | | |
|----------------|-------|----------------|--|
| Recycle finish | Info | [service name] | Recycle finish: [volume name] [volume size] [volume free] |
| Recycle fail | error | [service name] | Recycle fail: Disk space is insufficient |

Chapter Four Operation

⚠ IMPORTANT:

1. Before operating the NVR, make sure you have properly installed hard drives and configured the storage volumes. Otherwise, you will not be able to operate most of the system's functionality.
2. Since the NVR system comes with 32-bit plug-ins for screen control, if your PC runs a default 64-bit IE browser and you manually enter the NVR's address on the browser, your browser session may malfunction. Instead, if you double-click on the discovered NVR on the IW2 utility, a 32-bit IE browser will open.

4-1. Liveview

4-1-1. Placing Cameras into the Layout

Legends and definitions of icons on the layout panel have been described on page 32.

It is presumed that you have properly inserted all network cameras in your deployment as previously described on page 73. All 16 cameras should be listed on the Camera list.

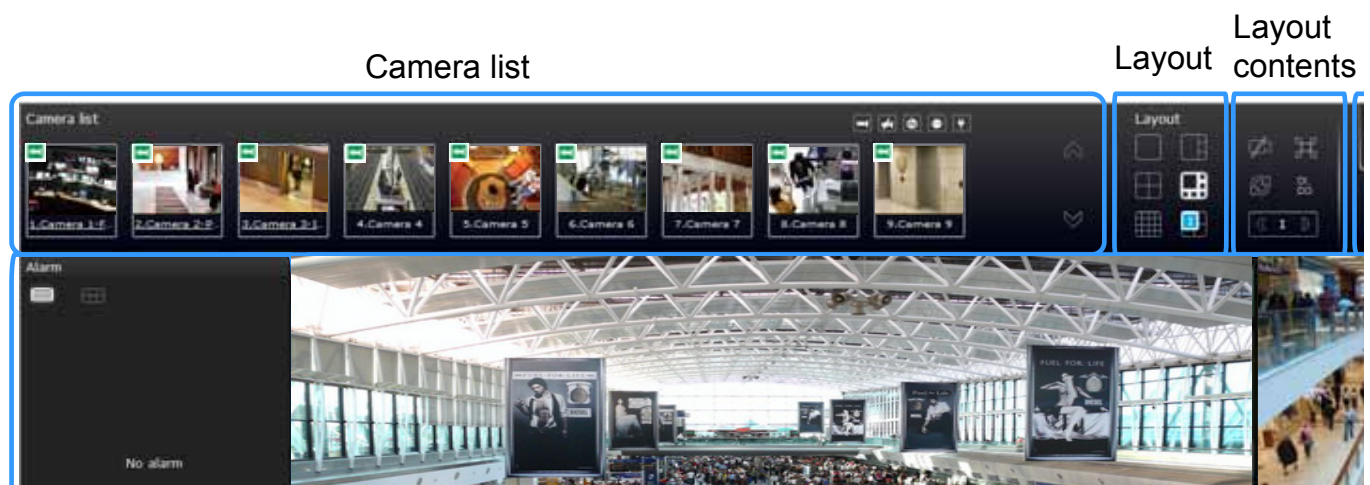

Note that layout design can only be performed by the system administrator.

To begin the design of your layout,

1. Select a layout pattern by a single click. The options are: 1x1, 1+3, 1+5, 2x2, and 4x4.

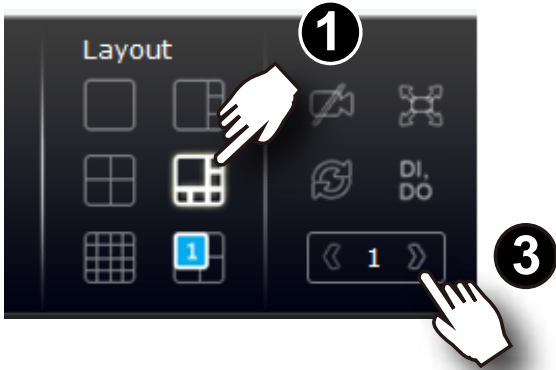

2. Click and drag cameras from the Camera list to empty cells on your layout. Repeat the action until you placed all your cameras into the layout. You may also double-click on a camera's thumbnail to fill it into the first unoccupied view cell.

2 Camera list



3. When you filled up the current layout, e.g., 6 camera into the 1+5 layout, click the page switch button to continue on the next layout page.

- When you are done with the current layout design, i.e., [the user layout 1](#), click **Save** to preserve your settings. This message prompts on the screen whenever any change is made to the current layout.



- You can create more user layouts by mouse-overing the user layout button. You may create more user layouts for different purposes, such as for the use of different users, or playing different views of a fisheye camera on multiple view cells.



The fisheye mode button is available on the view cell where you inserted a fisheye camera. When a regional view is displayed, the shooting angle and image orientation is kept with the layout. See page 41 to see more about fisheye viewing modes.



Placing different regional views of a fisheye camera into view cells will look like this:

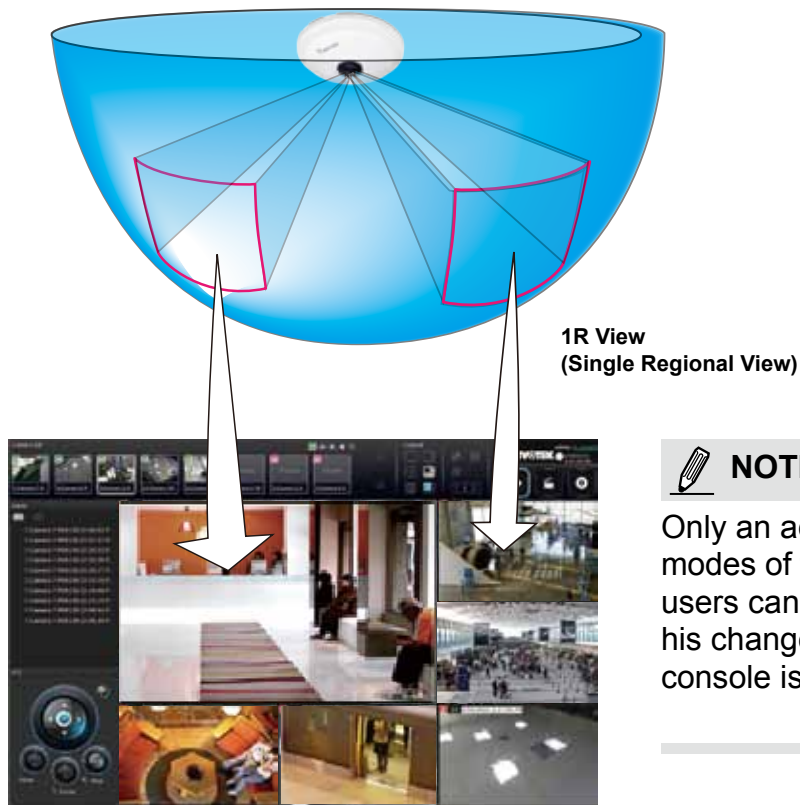

NOTE:
Only an administrator can alter the display modes of fisheye cameras. Although ordinary users can make changes to a regional view, his changes will not be preserved after a console is re-started.

In addition to fisheye cameras, if a camera has a wide field of view, you may also display its different fields of view in multiple view cells. Some view cell may also contain a PiP view that is digitally zoomed.

If users were created and some cameras are excluded from their access, a user may log in and see the locked-on cells as shown below:

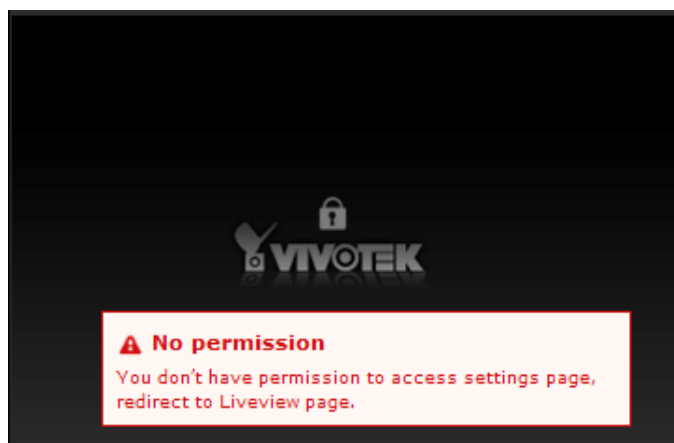

A user who has limited access rights may still re-arrange the layout of view cells. However, his configuration change will not be saved after he leaves the current console.



NOTE:

By default, every users or administrator logs in to the Live view window to the last layout page he visited. The last layout page a user visited during the previous console becomes the default layout.

4-1-2. PTZ and Other Screen Controls

Note that the PTZ control panel only applies when you select a view cell with a camera that comes with mechanical PTZ functions. Currently the e-PTZ function is not supported by the NVR system.

With a PTZ camera, the buttons on the PTZ panel become functional when you mouse over its GUI elements. For all compatible cameras and exerting Zoom, Focus, and Patrol functions, please refer to page 43 for details. The Zoom function, for example, requires a camera that comes with a motorized zoom module, and may not be applicable to every PTZ camera.



The preset positions and the patrol functions require the associated configuration on the cameras via a web console. Before you make use of these functions, you should set up the preset positions on a web console with the camera. The NVR GUI does not provide the configuration options with PTZ preset positions.

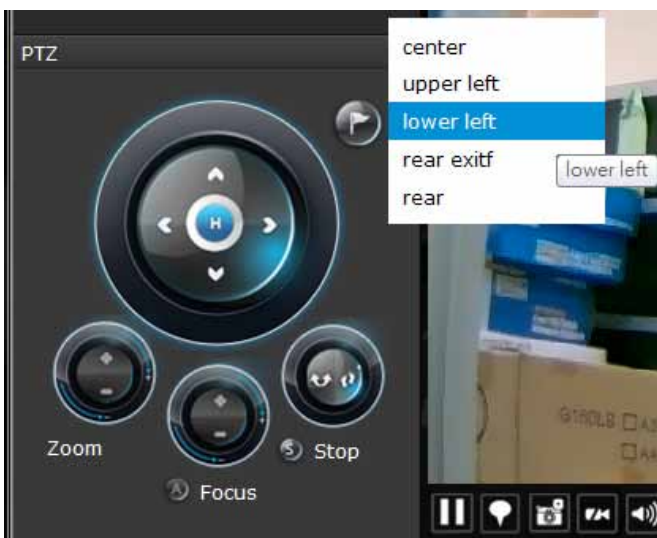

You can use **Preset** button to display preset positions and tell the camera to move and point at the preset direction, and to perform a camera tour to visit these positions in a consecutive order.

To access live view control,

1. **Click** on a view cell. The view cell will become a focused view cell. The streaming control buttons will be listed at the bottom of a view cell. These buttons have been discussed on page 37.
2. **The 2nd click** on a view cell enlarges it to the full of the live view area. **The 3rd click** reduces its size to the original focused view.
3. To deselect a view cell, you can click on another view cell in the display area or click on the Restore  button.

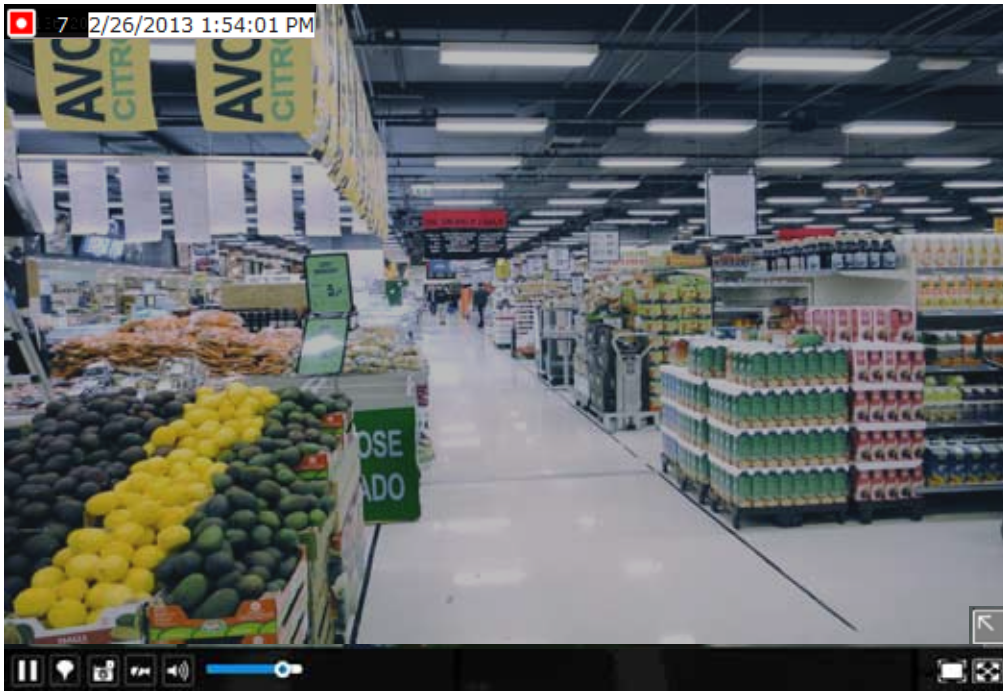

A selected, focused, view cell.



NOTE:

If you have concerns with the display quality and frame rate per second, refer to page 79 for how to configure video feeds for live viewing as well as for video recording. The configuration options can be found in **Settings > Camera > Video**.

Note that the constant bit rate methodology is applied in this system and it sets an upper threshold on the size of IP packets sent with the video streams. Image quality will be slightly compromised if reaching the ceiling of allowable bandwidth.

To place bookmarks and exert screen controls,

On a focused view cell, you can temporarily stop or start an ongoing streaming, or place a bookmark  that saves a short description and a one-minute footage from the current feed. The bookmark is also displayed along with the recorded video, and therefore it is easier to look for a specific moment in time when you need to trace back for a scenario later.

The bookmark function can be executed on a live or recorded stream when you observe a situation from your Live view or Playback window. The precondition of using this function is that the video stream, while you are watching it on the view cell, must be recorded to the NVR at the same time.

To add a bookmark,

1. Click on the button,
2. Enter a short description that can be as long as 120 characters.
3. Click on the + button or simply press Enter on your keyboard.



To Activate and Deactivate PiP function,

PiP is short for Picture in Picture, a function that provides digital zoom into a live video. When activated, a Global view window will appear at the lower right of the view cell as shown below. You can display only a portion of the complete video frame as an area of your interest. Using a click and drag on the ROI window, you can instantly move to other areas within the video frame.

You can resize the ROI window by a mouse hover on the lower-right corner of the window until the resize mark appears. The default size of the ROI window is 25% of the Global view.

Click on the deactivate  button to close the PiP window.

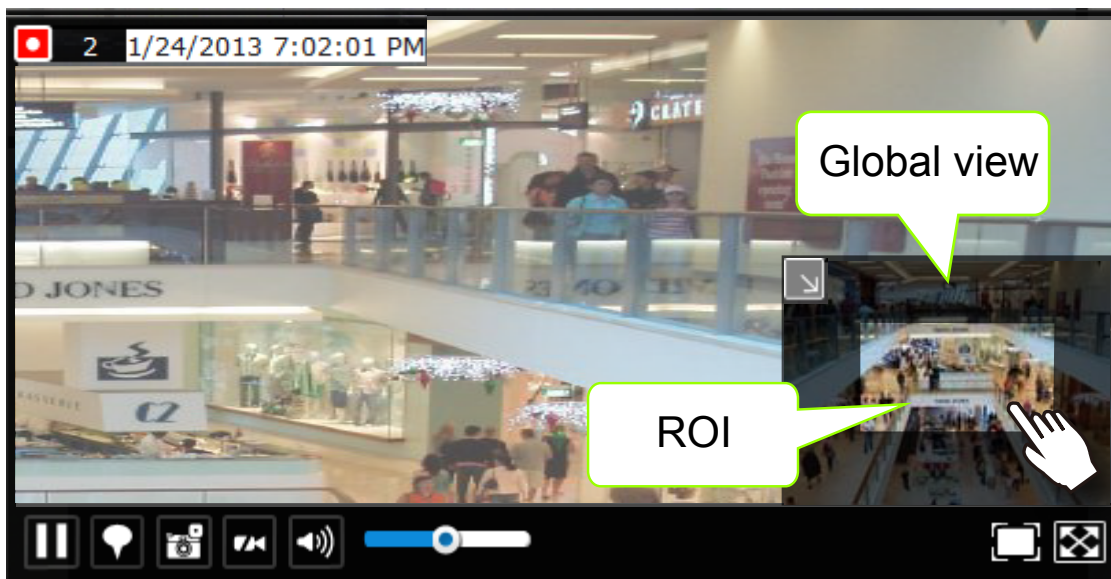



Note that not every camera supports the PiP function. For example, PTZ cameras and fisheye cameras do not support the PiP feature.

Refer to page 37 for GUI legends and individual functionality.

4-1-3. Audio

Audio is only transmitted through the camera in a view cell that is currently selected. You can manually tune the volume level, mute, or unmute the audio feed through a view cell.

4-1-4. Camera Properties and Controls

You can click on the underlined name entry of a camera on the camera list to open its properties window. Here you can find a short description of the camera name, address, and model name. You can also enable or disable the scheduled or continuous recording set for the camera. Click on their associated icons, , , to change their recording status.

For a camera that is not performing a continuous recording, you can click on the Manual Recording button, , to start a manual recording. The recording will stop using the same button.

You can also manually turn on the digital output , e.g., to trigger an external alarm that is connected to a specific camera.

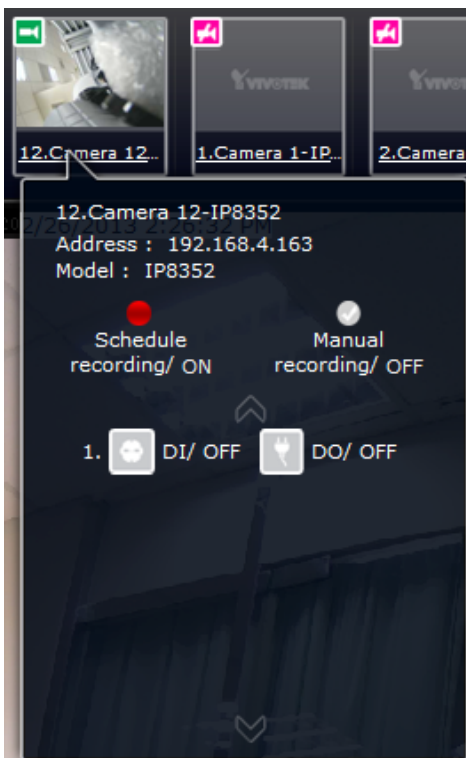

4-1-5. Alarm Panel

To receive alarms from cameras, you need to configure alarm triggers in the **Settings > Alarm** configuration window (see page 99). Network cameras' digital inputs, digital outputs, or motion detection can all be used to detect conditions in external environments. You can configure certain kind of actions to take place in response to the alarms: such as

1. recording the immediate image,
2. sends an Email notification,
3. sounds the onboard buzzer,
4. sends snapshots to an FTP server,
5. sends videos to web server,
6. moves camera lens to a preset location,
7. triggers a camera's digital output.

The operation details of the **Alarm panel** and **Alarm Playback** utility have been described on page 45.

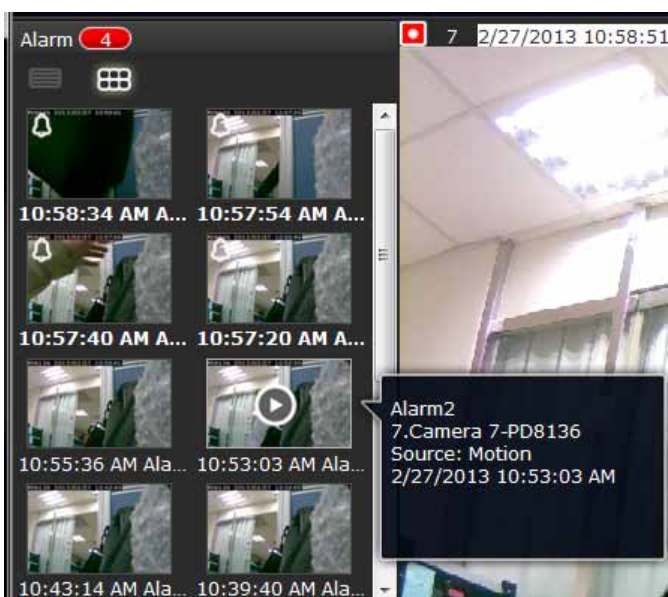
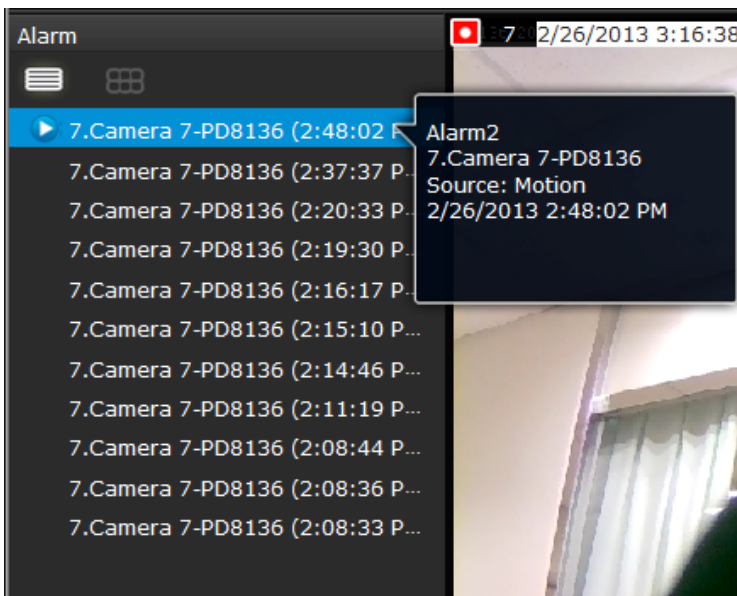

4-1-6. Layout view Control Buttons

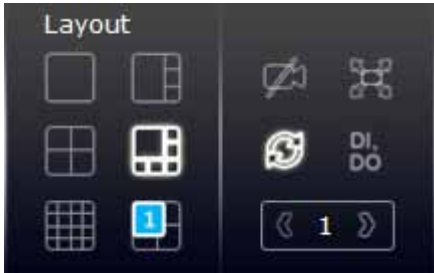

1. When editing a user layout, you can use this button to clear all view cells of inserted cameras.
2. This button extends the current layout to the full of the screen.
3. The Rotate function lets system display successive pages in a user layout **by the intervals of 10 seconds**. The layout page that does not contain camera views will be skipped.

A Rotate action will stop when you

1. move to another page in the user layout,
2. move to another user layout,
3. click to select a view cell,
4. remove a camera from view cell,
5. click to disable the rotation function.

When your current layout spans across multiple pages, use the arrow buttons to switch from one page to another. The index number of the current page will be shown between the arrow buttons.

4. The DI/DO panel displays the current digital input conditions and the manual trigger DO button. When a DO is triggered, it is indicated by a white circle. Click on the circular button in front of DO to trigger a DO signal.

A DO signal can also be associated with the Alarm setting for the NVR to take related actions, such as the Alarm recording.

Note that once triggered, the DO signal will be continuous and the DO-triggered events will prompt continuously. Click on the DO button again until the white circle disappears.

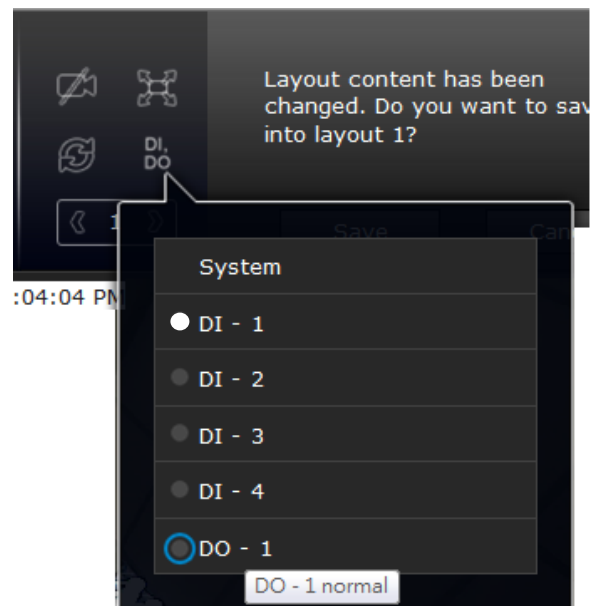

4-2. Playback

The elements in the Camera list on a **Playback** window are similar to those on a **Liveview** window. Please refer to page 30 for details on the Camera list panel.

However, on a Playback window, you can not:

1. Users **can not** click and drag a camera thumbnail to a playback view cell.
2. A double-click on a camera does not display video in a view cell. A double-click displays a **calendar** where days with recorded videos are shown.

4-2-1. Begin Playback and Search for Past Recordings

1. Select a layout. You can display the playback views of multiple cameras on one screen.
2. Select a view cell on the Playback window,
3. Double-click on a camera.
4. The **Calendar panel** will display the days video recording actually took place. And those days will be highlighted by a blue background (as the 25th and 28th in the screen below.)



 **NOTE:**

If a video stream is recorded in the **MJPEG** format, it will not be playable on the Playback window.

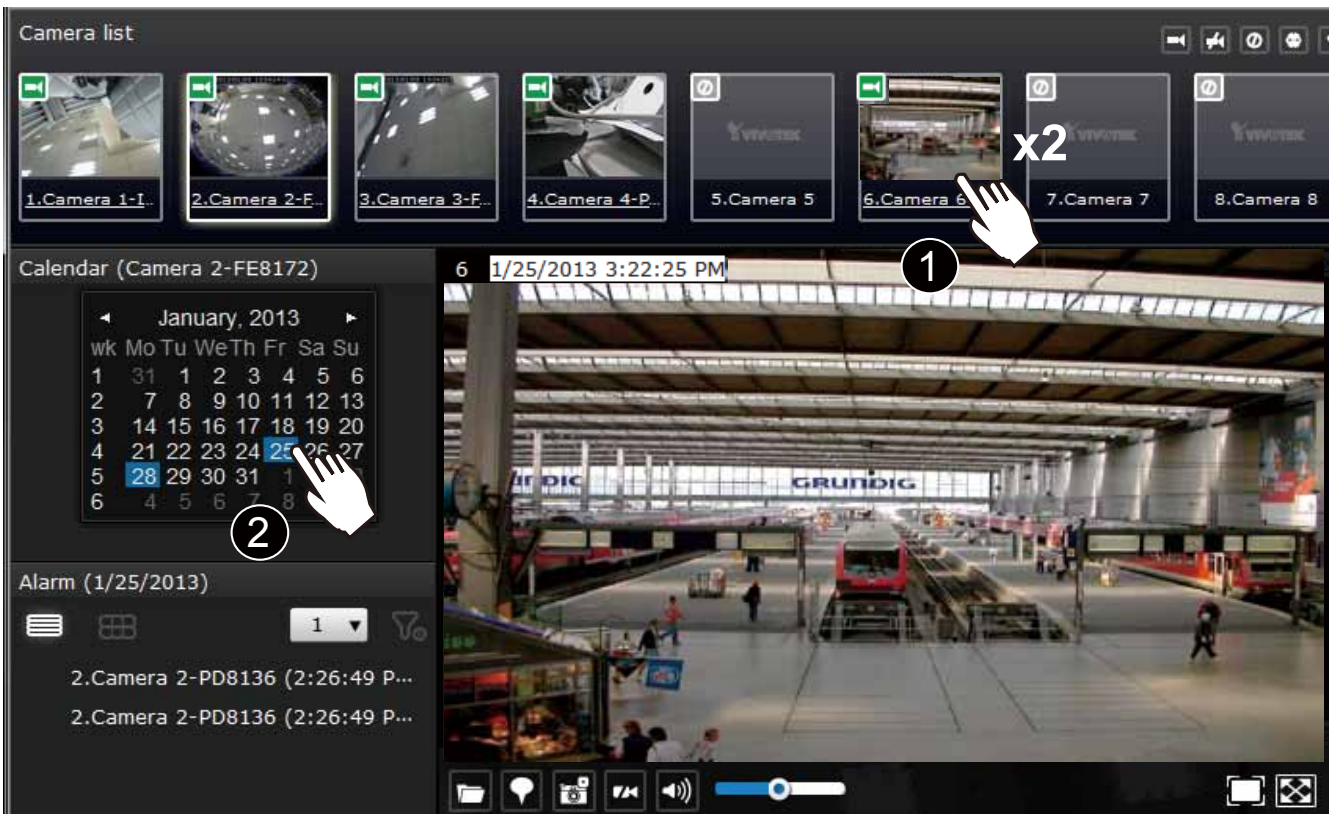

4-2-2. Past Alarms and Bookmarks

When you selected a day when alarms took place on a camera, the alarms will be listed on the Alarm panel. Up to 200 entries can be listed on a single page, and a max. of 1,000 entries across multiple pages.

You may then,

1. Mouse over the alarm thumbnails and click on the play button. The Playback window will then play back the video recorded by the time of the occurrence.
2. Unlike the **Alarm playback** function on the Liveview window, which only plays back the related video for only one minute, the alarm playback will continue throughout the recording of that day.

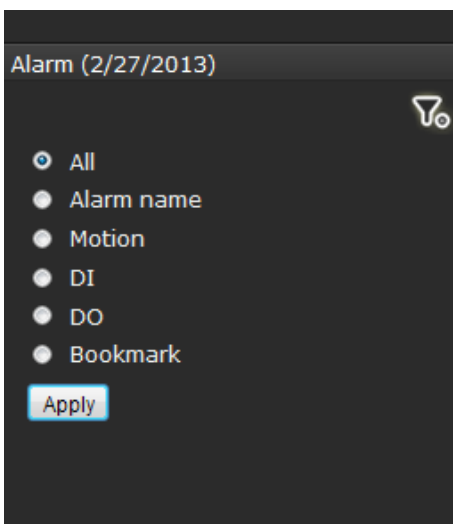
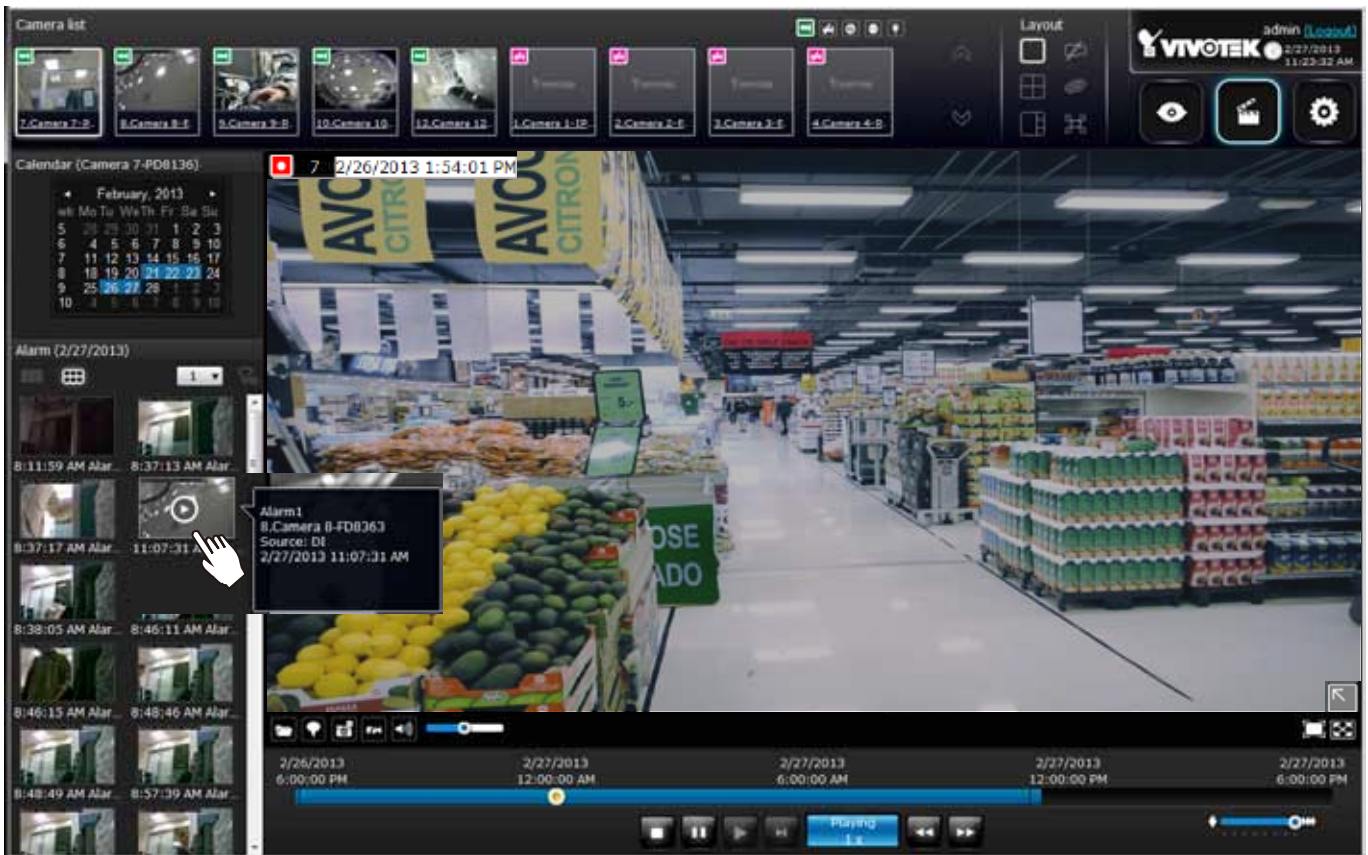

If you set up multiple triggering sources on a camera,

you can use the **Alarm filter**  button to find the alarms of a specific type.

You can select the check circles to narrow down the types of listed alarms using search criteria by **Alarm name**, **Motion**, **DI**, **DO**, or **Bookmark**.

Note that if searching by the Alarm name, the search does not apply to the camera model name that is automatically appended to the description of an alarm. Only the name of an alarm should apply in the search.

Note that the bookmarks you inserted on the Liveview window will be listed on the Alarm panel, and the bookmarks will also appear on the slide bar of the Playback window.

To retrieve or view the video clip tagged by the bookmark, click on it to play the video that was recorded by the time bookmark was inserted.

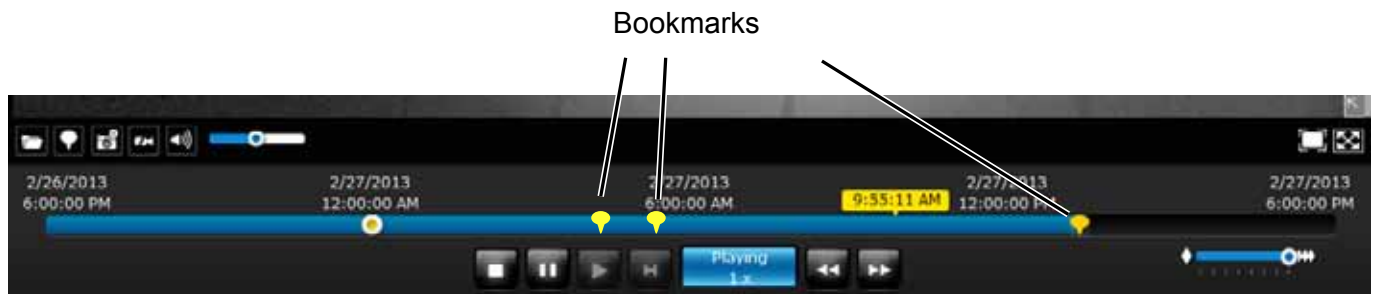

4-2-3. Synchronous Playback

The NVR supports synchronous playback, which allows you to review video clips from up to 4 cameras at the same time. These video clips will be retrieved simultaneously all playing for a specific point in time.

To perform synchronous playback:

1. Select a layout from the Layout panel, e.g., a 2x2 layout.
2. Click on the **Synchronous playback**  button.
3. Double-click to select a camera from the camera list. This camera becomes the Master camera.
4. When the Calendar panel appears, click to select a date your prefer.
5. Click and drag other cameras from the camera list to the empty view cells. These cameras will play back videos according to your operation on the Master camera.

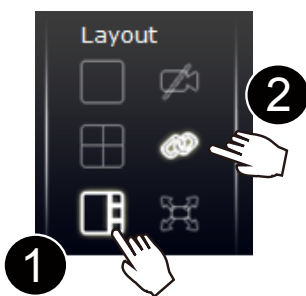

Note the following when using the Synchronous playback:

1. Only the alarms triggered on the Master camera will be shown. In the Synchronous mode, you can not find the alarms or bookmarks generated for other cameras.
2. The playback speed, selection of video clips, and alarm playback of all cameras are made synchronous.

4-2-4. Export media

To export video clips,

1. Click on the **Export media**  button on the tool bar, while the Playback window is playing a video section of your interest.
2. An Export media window will prompt.

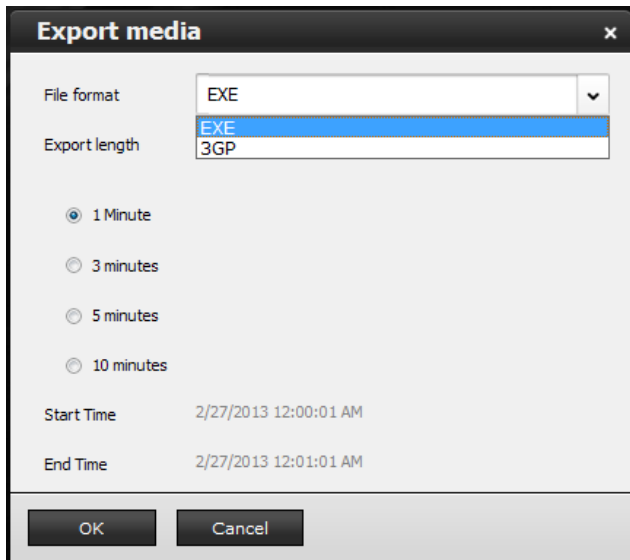

3. Select the file format using the pull-down menu. An **EXE** file is an self-executable file playable by an embedded Media Player, and is playable on systems running different OSES than the Windows. The 3GP format is a multimedia container format for 3G UMTS services. These files can be played on Quicktime, Realplayer, and VLC. The file name will look like this: [MAC]_[DATE]_[TIME]_[CAMERA_INDEX].[3gp/exe].
4. Select an export length of video by 1, 3, 5, or 10 minutes. The actual length can be longer due to the fact that the program needs to trace back to the previous I-frame for a complete rendering of video frames into the media.
5. Click **OK** to proceed.
6. System will prompt you for the EXE file. Click **Save** to proceed.

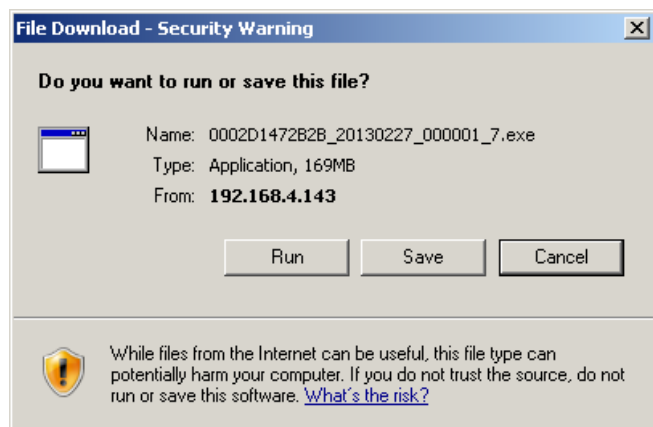

7. Select a location to store your file.



8. When the progress is done, click **Close**.

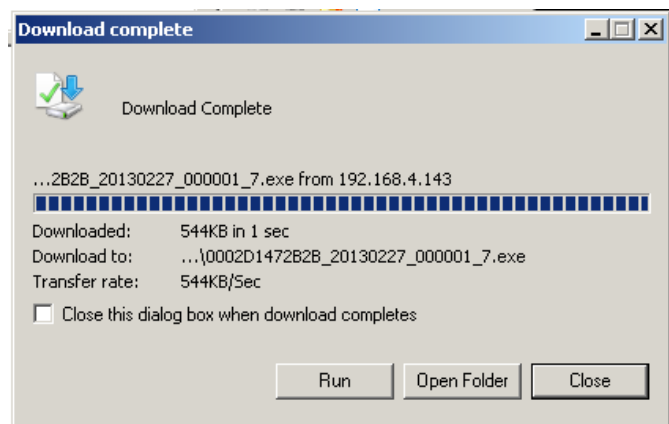

9. A self-executable EXE file should look like this.



If users select to export videos made of two different codecs (e.g., MPEG-4 and H.264), the following message will display:

Stop converting media due to streaming data has been changed.

Users should then find out the beginning of the time when video codec was changed in order to export another part of the footage.

4-2-5. Time Search

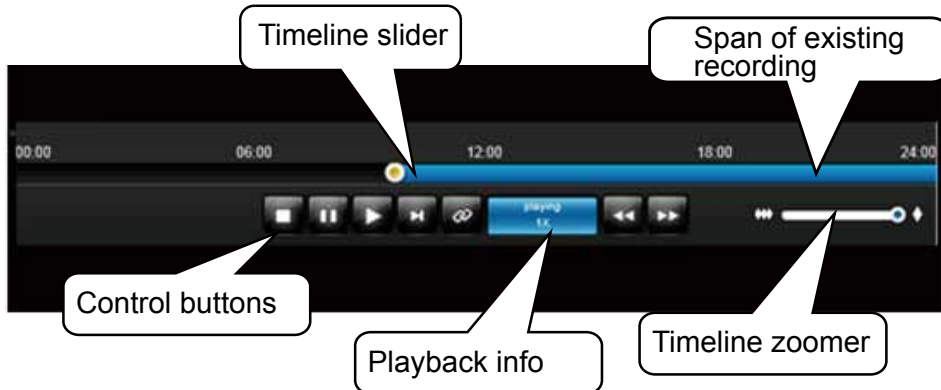

Use the time line slide bar to find the nearest recording from a specific point in time.

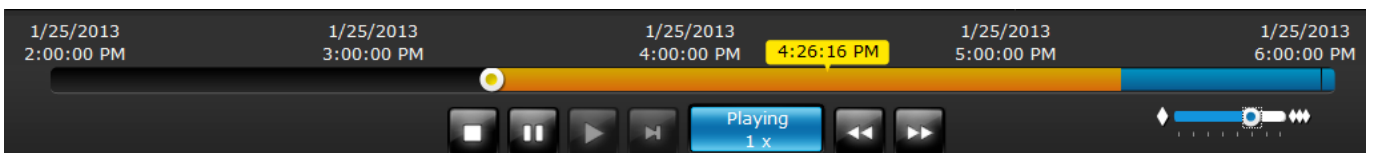

Details of the control bar in the Playback window can be found on [page 53](#).



If the need arises to more accurately pin-point the occurrence of an event, you can use the Timeline zoomer and the slider thumb on the time line for a closer view into the existing recording.

| | |
|---|--|
|  | <p>Timeline zoomer. Use the zoomer to zoom in for more precise skimming.</p> |
|  | <p>Timeline slider thumb. Click and drag this thumb button to move along and reach a specific point in time.</p> |

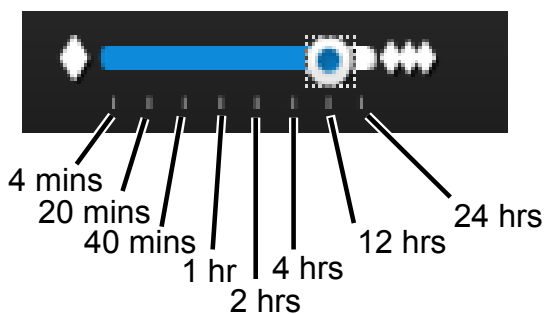

You can use the timeline zoomer to scale down the span of time. For example, if the time span is reduced to 1 hour, then each section on the time line represents 15 minutes of recording. The total time span on a timeline starts from the minimal of 4 minutes, 20 minutes, 40 minutes, 1 hour, and up to a maximum of 24 hours.

In the Synchronous play mode, a change to the zoomer will be reflected by all synchronously playing view cells.

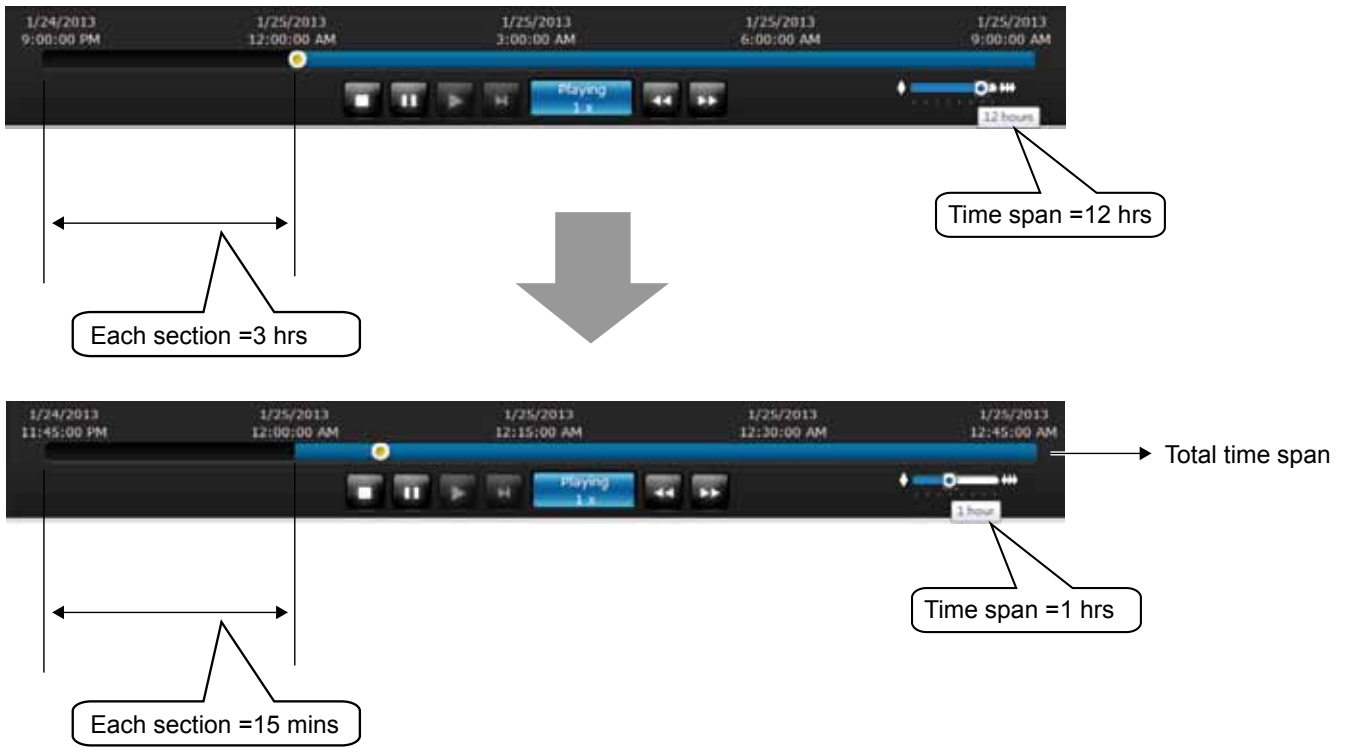

If recordings take place by an event-triggered recording, the intervals between recordings can be down to 1 minute, and the individual recordings will not be easily discernible. In this situation, you can mouse over the timeline to pin-point individual recording instances.

4-3. Other Functions - Using the Backup Button

The Backup function supports USB devices formatted in FAT32 or all other FAT file format.

The Backup function saves a replica of your system configuration profile to a USB drive. Once the USB is inserted, you should be able to hear two beeps, indicating the NVR has recognized the presence of the USB drive. You can then press the Backup button. The status LED will flash orange for 2 seconds, and the configuration backup is written to the USB drive.

You should then remove the USB drive.

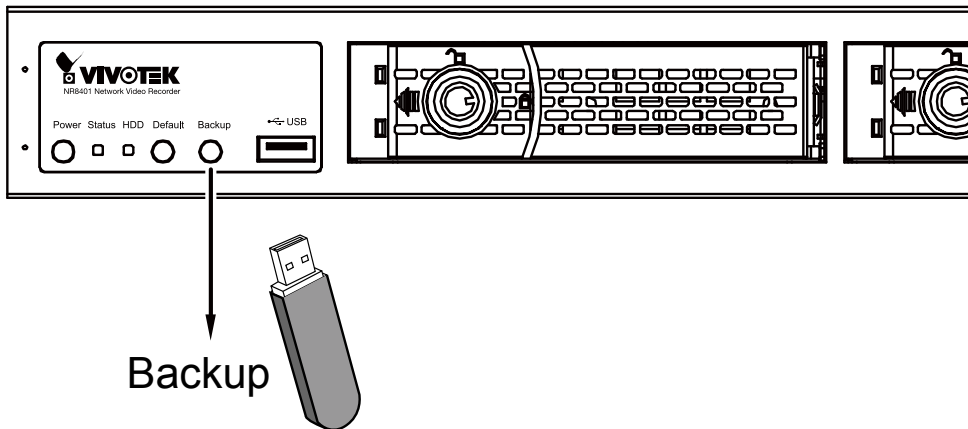

To restore from a previous backed-up file, insert the USB drive with a previously-saved profile. Press the Backup button for 4 to 5 seconds, and then wait for the system to reset itself. The process should take 3 or 4 minutes.

You can also restore from a previous backed-up file, in the **System > Backup** menu. Use the **Browse** button to locate the backup file. Click the **Restore** button.



A warning message will prompt. The current recording operation will be temporarily interrupted when restarting service. The process should take 3 or 4 minutes. After a reset, you system configuration will be restored to the previous state.

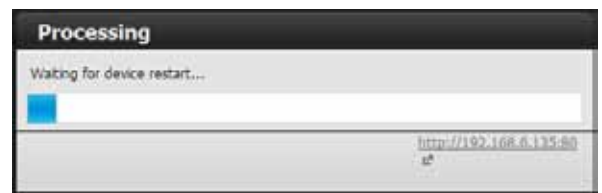
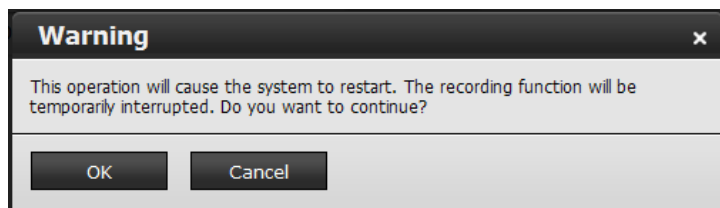

Technical Specifications

| Technical Specifications | |
|--|--|
| System | Playback |
| OS: Embedded Linux | Display Layout: 1x1/2x2/1+3 Playback Mode: play, pause, stop, next/frame, speed up/down (1/8, 1/4, 1/2, 1, 2, 4, 8, 16, 32, 64) 4-channel synchronous playback Search Mode: date/time & alarm mode (motion, DI/DO, Bookmark) Graphical timeline Snapshot Bookmark design Audio control Export: 3GP/EXE |
| Channels | Event/Alarm Management |
| 16-CH selectable | Source: motion, camera DI/DO, NVR DI/DO Actions: recording, email, buzzer, FTP, HTTP, camera preset position, camera DO, NVR DO Alarm history search (motion, DI, DO) |
| Storage | Security |
| 4 x 3.5" HDD, up to 16TB 3 x hot-swappable & lockable hard disk tray, 1 x internal hard disk tray HDD S.M.A.R.T.(Self-Monitoring Analysis and Reporting Technology) RAID 0, 1, 5 | User group setting with password protection Access list |
| Connectors | Backup |
| 2 x Gigabit RJ45 ethernet port 3 x USB 2.0 port (1 x front / 2 x back) 4 x DI and 1 x DO for external sensor or alarm 1 x RS232 (reserved) | Manual backup |
| Camera Compatibility | Mobile APP Support |
| Full integration with VIVOTEK network cameras | VIVOTEK iViewer (iOS/Android) |
| Networking | Dimension |
| IPv4, TCP/IP, HTTP, RTSP/RTP/RTCP, SMTP, DHCP, NTP, DNS, DDNS Network mode (TCP/IP configuration): failover/load balance/standalone Default: restore user name/password to default | 430 mm (W) x 421 mm (D) x 44 mm (H) |
| Recording | Weight |
| Throughput: Max. 96 Mbps Recording Policy: schedule (continuous/event mode), manual and alarm recording Video Compression: H.264/MPEG-4 Audio Compression: AMR/G.711/AAC Resolution: up to 5-Megapixel recording Format: 3GP | Net: 7.2 kg (without HDD) |
| Liveview | LED Indicator |
| Display Layout: 1x1, 2x2, 4x4, 1+3, 1+5 Rotate Freeze Snapshot Bookmark design Audio Control PiP video control Manual Trigger Camera DI/DO, NVR DI/DO Pan/Tilt/Zoom control of VIVOTEK cameras Preset location Auto pan/patrol | 1 x Power LED 1 x Status LED 1 x HDD LED 1 x Restore LED 1 x Backup LED |
| Button | Power |
| Power: on/off Default: restore user name/password to default Backup: backup/restore the NVR configuration file | Input: AC 100-240 V, 50-60 Hz Power Consumption: Max. 70W |
| | Approvals |
| | CE, FCC Class A, VCCI, C-Tick |
| | Operating Environments |
| | Temperature: 0°C ~ 40°C Humidity: 20%~95% RH |
| | Warranty |
| | 24 Months |
| | Language |
| | English, Deutsch, Espanol, French, Italiano, Portuguese, Traditional Chinese, Simplified Chinese, Japanese |
| | Included Accessories |
| | CD Content: user's manual, quick installation guide, Installation Wizard 2 Others: quick installation guide, warranty card, power cord |

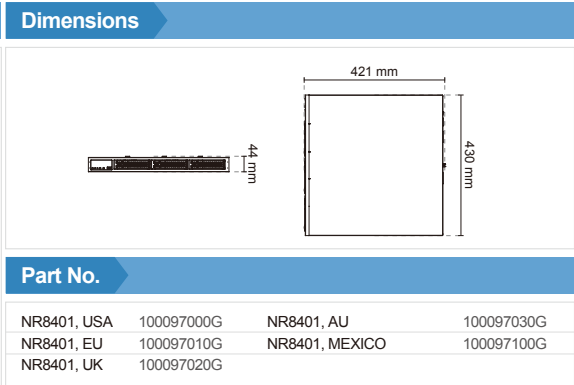
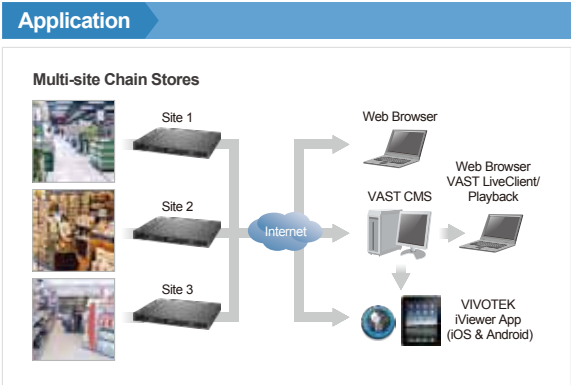

All specifications are subject to change without notice. Copyright © VIVOTEK INC. All rights reserved.

Distributed by:



VIVOTEK INC.
6F, No.192, Lien-Cheng Rd., Chung-Ho, New Taipei City, 235, Taiwan, R.O.C.
| T: +886-2-82455282 | F: +886-2-82455532 | E: sales@vivotek.com

VIVOTEK USA, INC.
2050 Ringwood Avenue, San Jose, CA 95131
| T: 408-773-8686 | F: 408-773-8298 | E: salesusa@vivotek.com

Ver 1.1

Safety and Compatibility



Federal Communications Commission (FCC) Statement

This Equipment has been tested and found to comply with the limits for a Class A digital device, pursuant to Part 15 of the FCC rules. These limits are designed to provide reasonable protection against harmful interference when the equipment is operated in a commercial environment. This equipment generates, uses and can radiate radio frequency energy and, if not installed and used in accordance with the instructions, may cause harmful interference to radio communications. Operation of this equipment in a residential area is likely to cause harmful interference in which case the user will be required to correct the interference at his own expense.

Warning:

[A shielded-type power cord is required in order to meet FCC emission limits and also to prevent interference to the nearby radio and television reception. It is essential that only the supplied power cord be used.]

[Use only shielded cables to connect I/O devices to this equipment.]

You are cautioned that changes or modifications not expressly approved by the party responsible for compliance could void your authority to operate the equipment.

[]: depend on EUT condition.



Information on Disposal for Users of Waste Electrical & Electronic Equipment (private households)

This symbol on the products and/or accompanying documents means that used electrical and electronic products should not be mixed with general household waste.

For proper treatment, recovery and recycling, please take these products to designated collection points, where they will be accepted on a free of charge basis. Alternatively, in some countries you may be able to return your products to your local retailer upon the purchase of an equivalent new product.

Disposing of this product correctly will help to save valuable resources and prevent any potential negative effects on human health and the environment which could otherwise arise from inappropriate waste handling. Please contact your local authority for further details of your nearest designated collection point.

Penalties may be applicable for incorrect disposal of this waste, in accordance with national legislation.

For business users in the European Union

If you wish to discard electrical and electronic equipment, please contact your dealer or supplier for further information.

Information on Disposal in other Countries outside the European Union

This symbol is only valid in the European Union. If you wish to discard this product, please contact your local authorities or dealer and ask for the correct method of disposal.

Japan VCCI Class A statement

この装置は、クラス A 情報技術装置です。この装置を家庭環境で使用すると電波妨害を引き起こすことがあります。この場合には使用者が適切な対策を講ずるよう要求されることがあります。

VCCI-A



ACA (Australian Communications Authority)